

**TPC Benchmark[®] C
Full Disclosure Report
for
Dell PowerEdge 2500
Using
Microsoft SQL Server 2000 8.0 Standard
Edition
and
Microsoft Windows 2000 Server**

First Edition
Submitted for Review
DEC 14, 2001

First Printing, DEC 14, 2001

Dell believes that the information included in this document is accurate as of the publication date. The information in this document is subject to change without notice. Furthermore, Dell is not responsible for any errors contained within this document.

The pricing information given in this FDR is accurate as of the publication date, DEC 14, 2001 and is generally available.

Benchmark results are highly dependent upon workload, specific application requirements, and system design and implementation. Relative system performance will vary as a result for these and other factors. Therefore, TPC Benchmark C should not be used as a substitute for a specific customer application benchmark when critical capacity planning and/or product evaluation decisions are contemplated.

All performance data contained in this report were obtained in a rigorously controlled environment. Actual performance experienced by a particular customer may vary due to differences in system layout and configuration, hardware and/or software revision levels, and background system activity. The content of this document is for informational purposes only.

Copyright 2000 Dell

All rights reserved. Permission is hereby granted to reproduce this document in whole or in part provided the copyright notice printed above is set forth in full text or on the title page of each item reproduced.

PowerEdge is a trademark of Dell.

Microsoft, Windows 2000 and SQL Server are registered trademarks of Microsoft Corporation.

TPC Benchmark, TPC-C and tpmC are registered trademarks of the Transaction Processing Performance Council.

Intel and Pentium are registered trademarks of Intel Corporation.

Other product names mentioned in this document may be trademarks and/or registered trademarks of their respective companies.

Abstract

Overview

This report documents the methodology and results of the TPC Benchmark™ C test conducted on Dell PowerEdge 2500. The tests were run in a client/server configuration using a PowerEdge 1400 as the client. The operating system used for the benchmark was Microsoft Windows 2000 Server on the database server and Microsoft Windows 2000 Server on the client. The database was Microsoft SQL Server 2000 Standard Edition. Microsoft COM+ provided the database connection queues. All tests were done in compliance with Revision 3.5 of the Transaction Processing Council's TPC Benchmark™ C Standard Specification. Two standard TPC Benchmark™ C metrics, transactions per minute (tpmC) and price per tpmC (\$/tpmC) are reported and referred to in this document. The results from the tests are summarized below.

Hardware	Software	Total System Cost	tpmC	\$/tpmC	Availability Date
Dell PowerEdge 2500 1 Processors	Microsoft Windows 2000 Server SQL Server 2000 Standard Edition	\$49,484	11314.11	\$4.38	DEC 14, 2001

Auditor

The results of the benchmark and test methodology used to produce the results were audited by Lorna Livingtree of Performance Metrics and have fully met the TPC-C rev 3.5 specifications.

Additional copies of this Full Disclosure Report can be obtained from either the Transaction Processing Performance Council or Dell at the following address:

Transaction Processing Performance Council (TPC)
c/o LoBue&Majdalany
404 Balboa Street
San Francisco, CA, 94118
Phone: (415) 750-8350, fax 751-4829
www.tpc.org

or

Dell
1 Dell Drive
Round Rock, TX 78682
Attention: Mike Molloy



PowerEdge 2500

Client/Server w/1 PE1400 Front End

TPC-C Rev 5.0
Report Date
DEC 14, 2001

Total System Cost	TPC-C Throughput	Price/Performance	Availability Date	
\$49,484	11,314.11 tpmC	\$4.38/ tpmC	DEC 14, 2001	
Processors	Database Manager	OS	Other Software	Number of Users
1 x Pentium® III Processors 1130 MHz 512KB L2 Cache	Microsoft SQL Server 2000 Standard Edition	Microsoft Windows 2000 Server	Windows 2000 Server w/ COM+ Internet Information Server 5.0 Microsoft Visual C++	9,120

PE2500

w/ 1 1130 MHz Pentium® III CPU w/ 512KB L2 cache, 2.25GB RAM, 3 Mylex AcceleRAID352 RAID Controllers, 4 18GB 10K RPM U2 SCSI Disks

4 PV210S Disk Pods
48 18GB 10K RPM U3 SCSI Disks

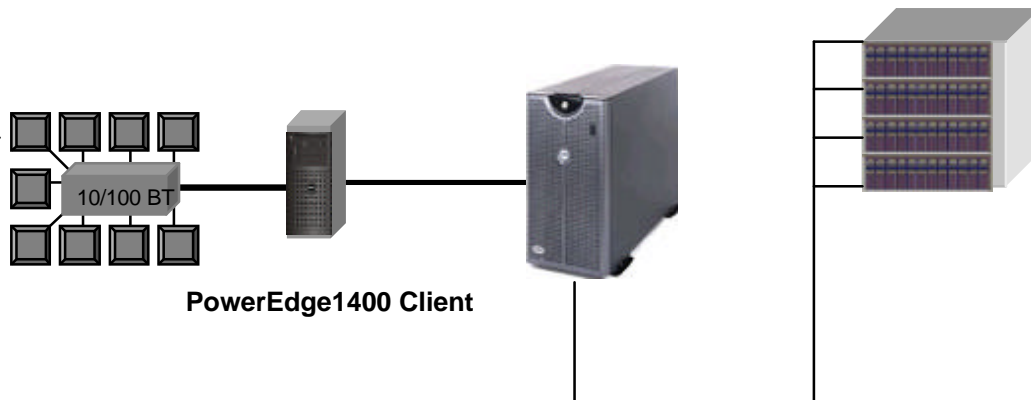

System Component	Server		Each Client	
Processors	1	Pentium® III @ 1130MHz w/ 512KB L2	1	Pentium® III @ 1000MHz w/ 256 KB L2
Cache				
Memory		2304 MB		512 MB
Disk Controllers	3	Mylex AcceleRAID 352	1	Adaptec On-Board
	2	Adaptec On-Board		
Disk Drives	1	9 GB SCSI	1	9 GB
	52	18 GB SCSI		
Total Storage		880 GB		9 GB
Other	1	10/100 BT internal NIC	1	
	1	CD-ROM	1	
	1	Tape Backup Unit		

Dell		PowerEdge 2500		TPC-C REV 5.0 EXECUTIVE SUMMARY PAGE 2 OF 2			
		Client/Server		Report Date: 14-Dec-01			
Description	Part Number	Third Party Brand	Pricing	Unit Price	Qty	Extended Price	3-yr. Maint. Price
Server Hardware							
Dell PowerEdge 2500 includes: Pentium III Xeon 1.13 GHz /512KB L2 - 1 processor	220-6475		1	1,221	1	1,221	748
2 GB RAM, 4 x 512MB DIMMS	311-6574		1	1,796	1	1,796	
256 MB RAM, 2 x 128MB DIMMS	311-6567		1	204	1	204	
6 Bay HD Back Plane	311-6578		1	179	1	179	
Non-Redundant Power Supply	310-0846		1	199	1	199	
9 GB U160M SCSI 10K RPM Hard Drive	340-1937		1	249	1	249	
Tape Backup Unit	340-2559		1	699	1	699	
Dell 15" Monitor	320-0960		1	149	1	149	
ACCELER RAID A352 PCI SCSI 2 channel RAID controller****	08P2420	Mylex	3	595	5	2,975	
Subtotal						7,671	748
PowerVault Disk Subsystem							
PV210S, U3 SCSI, PS, Rack mount	220-4099, etc.		1	2,539	4	10,156	2,400
SCSI Cables	310-0313		1	49	4	196	
18 GB U160M SMRT SCSI 10K RPM Hard Drive *	340-6639		1	249	52	12,948	
Subtotal						23,300	2,400
Server Software							
SQL Server 2000 Sta. Edition, Per processor licensing **		Microsoft	2	4,999	1	4,999	6,288
Windows 2000 Server, 25 Client Licenses **		Microsoft	2	738	1	738	
Subtotal						5,737	6,288
Client Hardware							
Dell PowerEdge 1400SC, 1GHz Pentium III w/ 256KB L2	220-2333		1	786	1	786	398
512MB RAM, 1 DIMM	311-1194		1	408	1	408	
9GB LVD SCSI Hard Drive,	340-1964		1	249	1	249	
Ether Express PRO 100+ Ethernet Adapter	430-1970	Intel	1	59	1	59	
Dell 15" Monitor	320-0960		1	149	1	149	
Subtotal						1,651	398
Client Software							
Windows 2000 Server, 5 Client Licenses **		Microsoft	2	738	1	738	
Visual C++ Professional 6.0 Win32 **		Microsoft	2	549	1	549	
Subtotal						1,287	
User Connectivity							
Crossover Cable 6ft***	CLB514	OCSUSA	4	2	3	6	
Subtotal						6	
Other Discounts						-	
Total						39,652	9,838
Notes: * Maint. included in PowerVault 210S disk pod or PV650F/630F fibre channel disk pod						Three-Year Cost of Ownership: \$49,484	
** All Microsoft maintenance is covered by the maintenance costs of Microsoft SQL Server							
*** 10% or minimum 2 spares are added in place of onsite service (products have a five year return-to-vendor warranty) Pricing: 1 - Dell 2 - Microsoft 3 - Computer Giants 4 - OCSUSA						tpmC Rating: 11314.11	
**** Substituting for ExtremeRAID 2000. See Auditor's note in FDR							
Audited by Lorna Livingtree, Performance Metrics Inc.						\$/tpmC: 4.38	
Prices used in TPC benchmarks reflect the actual prices a customer would pay for a one-time purchase of the stated components. Individually negotiated discounts are not permitted. Special prices based on assumptions about past or future purchases are not permitted. All discounts reflect standard pricing policies for the listed components. For complete details, see the pricing sections of the TPC benchmark specifications. If you find that the stated prices are not available according to these items, please inform the TPC at pricing@tpc.org.							

MQTh, computed Maximum Qualified Throughput

11314.11
tpmC

Response Times (in seconds)

	Average	90th	Max
- Neworder	0.51	0.74	6.91
- Payment	0.30	0.46	5.01
- Order Status	0.38	0.58	8.07
- Delivery (interactive portion)	0.15	0.26	0.79
- Delivery (deferred portion)	0.71	1.14	2.48
- Stock-Level	3.19	4.32	9.93
- Menu	0.15	0.27	0.97

Response time delay added for emulated components

Menu 0.15
Resp 0.15

Transaction Mix, in percent of total transactions

- New-Order	44.85%
- Payment	43.02 %
- Order-Status	4.04 %
- Delivery	4.05 %
- Stock-Level	4.04 %

Keying/Think Times (in seconds),

	Min		Average		Max	
- New-Order	18.03	0.0	18.01	12.06	18.04	120.41
- Payment	3.03	0.0	3.02	12.03	3.04	120.41
- Order-Status	2.03	0.0	2.02	10.07	2.04	100.40
- Delivery	2.03	0.0	2.02	5.06	2.04	50.40
- Stock-Level	2.03	0.0	2.02	5.06	2.04	50.40

Test Duration

- Ramp-up time	5 minutes
- Measurement interval	120 minutes
- Number of checkpoints	1
- Checkpoint interval	30 minutes
- Number of transactions (all types) completed in measurement interval	3,149,348

Table of Contents

ABSTRACT	1
OVERVIEW.....	1
AUDITOR.....	1
TABLE OF CONTENTS	2
INTRODUCTION.....	7
DOCUMENT STRUCTURE	7
BENCHMARK OVERVIEW.....	7
SYSTEM OVERVIEW.....	8
GENERAL ITEMS	9
TEST SPONSOR	9
APPLICATION CODE AND DEFINITION STATEMENTS	9
PARAMETER SETTINGS	9
CONFIGURATION DIAGRAMS	10
CLAUSE 1 -- LOGICAL DATABASE DESIGN RELATED ITEMS	13
TABLE DEFINITIONS	13
PHYSICAL ORGANIZATION OF THE DATABASE	13
INSERT AND DELETE OPERATIONS	13
HORIZONTAL AND VERTICAL PARTITIONING	13
REPLICATION.....	13
TABLE ATTRIBUTES	13
CLAUSE 2 -- TRANSACTION AND TERMINAL PROFILES RELATED ITEMS	14
RANDOM NUMBER GENERATION	14
SCREEN LAYOUT.....	14
TERMINAL VERIFICATION.....	14
INTELLIGENT TERMINALS.....	14
TRANSACTION PROFILES.....	14
TRANSACTION MIX	15
DEFERRED DELIVERY MECHANISM.....	15
CLAUSE 3 -- TRANSACTION AND SYSTEM PROPERTIES RELATED ITEMS.....	16
ACID TESTS	16
<i>Atomicity</i>	16
<i>Consistency</i>	16
<i>Isolation</i>	16
<i>Durability</i>	17
CLAUSE 4 -- SCALING AND DATABASE POPULATION RELATED ITEMS	19
TABLE CARDINALITY	19
CONSTANT VALUES	19
DATA DISTRIBUTION	20
PARTITION MAPPING.....	22
60 DAY SPACE CALCULATION.....	22
CLAUSE 5 -- PERFORMANCE METRICS AND RESPONSE TIME RELATED ITEMS	23

MEASURED TPMC	23
RESPONSE TIMES	23
THINK TIMES & KEY TIMES	23
RESPONSE TIME DISTRIBUTION CURVES.....	24
NEW-ORDER RESPONSE TIME VS. THROUGHPUT GRAPH	27
NEW-ORDER THINK TIME DISTRIBUTION GRAPH.....	28
STEADY-STATE GRAPH.....	28
STEADY-STATE METHODOLOGY	29
WORK PERFORMED DURING STEADY STATE	29
REPRODUCIBILITY METHODOLOGY	29
MEASUREMENT INTERVAL	ERROR! BOOKMARK NOT DEFINED.
TRANSACTION MIX	30
OTHER METRICS	30
CHECKPOINTS.....	ERROR! BOOKMARK NOT DEFINED.
CLAUSE 6 -- SUT, DRIVER, AND COMMUNICATION DEFINITION RELATED ITEMS	32
RTE PARAMETERS	32
EMULATED COMPONENTS	32
BENCHMARKED AND TARGETED SYSTEM CONFIGURATION DIAGRAMS	32
NETWORK CONFIGURATION.....	32
NETWORK BANDWIDTH	32
OPERATOR INTERVENTION	33
CLAUSE 7 -- PRICING RELATED ITEMS.....	34
HARDWARE AND SOFTWARE LIST.....	34
AVAILABILITY DATE	34
MEASURED TPMC	34
COUNTRY SPECIFIC PRICING.....	34
USAGE PRICING	34
SYSTEM PRICING	35
CLAUSE 9 -- AUDIT RELATED ITEMS.....	36
AUDITOR.....	36
AVAILABILITY OF THE FULL DISCLOSURE REPORT	36
AUDITOR'S LETTER OF ATTESTATION.....	37
APPENDIX A - APPLICATION SOURCE CODE	39
TPCC.DLL ISAPI DLL SOURCE CODE	39
<i>isapi_dll/src/tpcc.def</i>	39
<i>isapi_dll/src/tpcc.h</i>	39
<i>isapi_dll/src/tpcc.rc</i>	41
<i>isapi_dll/src/tpcc.cpp</i>	42
<i>isapi_dll/src/resource.h</i>	63
<i>common/src/ReadRegistry.cpp</i>	63
<i>common/src/ReadRegistry.h</i>	64
<i>common/src/error.h</i>	65
<i>common/src/trans.h</i>	67
<i>common/src/txn_base.h</i>	68
<i>db_dblib_dll/src/tpcc_dblib.cpp</i>	69
<i>db_dblib_dll/src/tpcc_dblib.h</i>	78
<i>tm_com_dll/src/tpcc_com.cpp</i>	79
<i>tm_com_dll/src/tpcc_com.h</i>	81
<i>tpcc_com_all/src/methods.h</i>	82
<i>tpcc_com_all/src/resource.h</i>	85

<i>tpcc_com_all/src/tpcc_com_all.cpp</i>	85
<i>tpcc_com_all/src/tpcc_com_all.def</i>	90
<i>tpcc_com_all/src/tpcc_com_all.h</i>	90
<i>tpcc_com_all/src/tpcc_com_all.idl</i>	91
<i>tpcc_com_all/src/tpcc_com_all.rc</i>	92
<i>tpcc_com_all/src/tpcc_com_all.rgs</i>	93
<i>tpcc_com_all/src/tpcc_com_all_i.c</i>	93
<i>tpcc_com_all/src/tpcc_com_no.rgs</i>	95
<i>tpcc_com_all/src/tpcc_com_os.rgs</i>	95
<i>tpcc_com_all/src/tpcc_com_pay.rgs</i>	95
<i>tpcc_com_all/src/tpcc_com_ps.h</i>	96
<i>tpcc_com_all/src/tpcc_com_sl.rgs</i>	98
<i>tpcc_com_ps/src/dlldata.c</i>	98
<i>tpcc_com_ps/src/tpcc_com_ps.def</i>	99
<i>tpcc_com_ps/src/tpcc_com_ps.h</i>	99
<i>tpcc_com_ps/src/tpcc_com_ps.idl</i>	101
<i>tpcc_com_ps/src/tpcc_com_ps_i.c</i>	102
<i>tpcc_com_ps/src/tpcc_com_ps_p.c</i>	103
<i>common/txnlog/include/rtetime.h</i>	124
<i>common/txnlog/include/spinlock.h</i>	124
<i>common/txnlog/include/txnlog.h</i>	125
APPENDIX B - DATABASE DESIGN	129
BUILD SCRIPTS	129
<i>setup.cmd</i>	129
<i>createdb.sql</i>	130
<i>tables.sql</i>	131
<i>idxcuscl.sql</i>	132
<i>idxcusnc.sql</i>	132
<i>idxdiscl.sql</i>	132
<i>idxitmcl.sql</i>	133
<i>idxnodcl.sql</i>	133
<i>idxodlcl.sql</i>	133
<i>idxordcl.sql</i>	134
<i>idxstkcl.sql</i>	134
<i>idxwarcl.sql</i>	134
<i>dbopt1.sql</i>	134
<i>dbopt2.sql</i>	135
<i>dbopt3.sql</i>	135
<i>backup.sql</i>	135
<i>restore.sql</i>	136
STORED PROCEDURES	137
<i>neword.sql</i>	137
<i>payment.sql</i>	139
<i>ordstat.sql</i>	141
<i>delivery.sql</i>	142
<i>stocklev.sql</i>	143
LOADER SOURCE CODE	143
<i>tpcc.h</i>	143
<i>tpccldr.c</i>	145
<i>getargs.c</i>	165
<i>random.c</i>	166
<i>strings.c</i>	168
<i>time.c</i>	171

APPENDIX C - TUNABLE PARAMETERS	172
SERVER CONFIGURATION PARAMETERS	172
Microsoft Windows 2000 Advanced Server Parameters	172
Microsoft Windows 2000 Advanced Server Configuration.....	172
Microsoft SQL Server Version 7.0 Startup Parameters.....	172
Microsoft SQL Server Stack Size	173
Mylex Device Drivers and Firmware.....	173
Mylex Registry Key.....	173
Qlogic Device Driver.....	Error! Bookmark not defined.
Giganet Registry Key.....	Error! Bookmark not defined.
Microsoft SQL Server 7.0 Configuration Parameters.....	173
Windows 2000 Advanced Server System Information Report For PE6400	174
CLIENT CONFIGURATION PARAMETERS	215
COM+ Settings.....	215
TPCC Application Registry Parameters.....	215
Microsoft Internet Information Server Registry Parameters.....	215
World Wide Web Service Registry Parameters	Error! Bookmark not defined.
Microsoft Windows 2000 Server System Information Report for PE1300.....	Error! Bookmark not defined.
RTE INPUT PARAMETERS	217
BenchCraft Configuration File	266
APPENDIX D – DISK STORAGE	273
60 DAY SPACE	ERROR! BOOKMARK NOT DEFINED.
APPENDIX E - PRICE QUOTATIONS	275

Introduction

Document Structure

The TPC Benchmark C Standard Specification Revision 3.5, written and approved by the Transaction Processing Performance Council (TPC), determines the contents of this report. The format of this report is based on this specification. Most sections of this report begin with the specification requirements printed in italic type, immediately followed by the detail in plain type of how Dell complied with the specification. Where extensive listings are required (such as listing of code), a note is included which references an appendix containing the listing.

Benchmark Overview

TPC Benchmark™ C (TPC-C) is an OLTP workload. It is a mixture of read-only and update intensive transactions that simulate the activities found in complex OLTP application environments. It does so by exercising a breadth of system components associated with such environments, which are characterized by:

- The simultaneous execution of multiple transaction types that span a breadth of complexity
- On-line and deferred transaction execution modes
- Multiple on-line terminal sessions
- Moderate system and application execution time
- Significant disk input/output
- Transaction integrity (ACID properties)
- Non-uniform distribution of data access through primary and secondary keys
- Databases consisting of many tables with a wide variety of sizes, attributes, and relationships
- Contention on data access and update

The performance metric reported by TPC-C is a "business throughput" measuring the number of orders processed per minute. Multiple transactions are used to simulate the business activity of processing an order, and each transaction is subject to a response time constraint.

The performance metric for this benchmark is expressed in transactions-per-minute-C (tpmC). To be compliant with the TPC-C standard, all references to tpmC results must include the tpmC rate, the associated price-per-tpmC, and the availability date of the priced configuration.

Although these specifications express implementation in terms of a relational data model with conventional locking scheme, the database may be implemented using any commercially available database management system (DBMS), database server, file system, or other data repository that provides a functionally equivalent implementation. The terms "table", "row", and "column" are used in this document only as examples of logical data structures.

TPC-C uses terminology and metrics that are similar to other benchmarks, originated by the TPC or others. Such similarity in terminology does not in any way imply that TPC-C results are comparable to other benchmarks. The only benchmark results comparable to TPC-C are other TPC-C results conformant with the same revision.

Despite the fact that this benchmark offers a rich environment that emulates many OLTP applications, this benchmark does not reflect the entire range of OLTP requirements. In addition, the extent to which a customer can achieve the results reported by a vendor is highly dependent on how closely TPC-C approximates the customer application. The relative performance of

systems derived from this benchmark does not necessarily hold for other workloads or environments. Extrapolations to any other environment are not recommended.

Benchmark results are highly dependent upon workload, specific application requirements, and systems design and implementation. Relative system performance will vary as a result of these and other factors. Therefore, TPC-C should not be used as a substitute for a specific customer application benchmarking when critical capacity planning and/or product evaluation decisions are contemplated.

System Overview

The hardware configuration used in this TPC-C test is a Dell PowerEdge 2500 server driven by a Dell PowerEdge 1400 client. The client and server are networked together via a CAT 5 Cross-over Cable. Six remote terminal emulator (RTE) systems (PowerEdge 2200's) emulate 9,120 users executing the standard TPC-C workload. The RTE's are connected to the client through a 10/100 BaseT switch. The switch connects to the client machine at 100 BaseT and to the RTE machines at 10Mbit/sec, half duplex. Microsoft Windows 2000 Server was the operating system used on the server and client systems. Microsoft SQL Server 2000 Standard Edition was the database on the server machine.

The PowerEdge 2500 motherboard uses the ServerWorks High End-SL (HE-SL) chipset and can hold up to two Pentium® III Xeon™ processors (1130 MHz with 512 KB L2 cache on each). The system has 8 PCI I/O slots (2 x 64bit/66MHz; 4 x 64-bit/33MHz; 2 x 32-bit/33MHz). The measured configuration used 2.25 Gbytes of RAM, which was achieved by using four 512 Mbyte DIMMs and two 128 Mbyte DIMMs.

The PowerEdge 2500 has an integrated Adaptec AIC-7899 U160 SCSI controller to which was attached one 9 GB disk drive containing the operating system. In addition, three Mylex AcceleRAID 352 2-channel RAID controllers were installed in three PCI slots and connected to 4 PowerVault 210S disk pods, which can hold 12 disks each and a single onboard 6-bay (split backplane) enclosure. The 4 pods were filled with 48 18 GB disks, all containing the database data. Additionally, the onboard enclosure held 4 disk drives. These 4 disk drives were mirrored using RAID 10 and were configured for transaction log data. Finally the embedded Intel PRO/100+ server adapter provided a connection to the client.

The client had a single Pentium® III processor at 1000 MHz with 256 Kbytes of L2 cache. The client had 512 Mbytes of RAM, one 9 GB hard disk, one add-on Intel Ether Express Pro100+ PCI Ethernet adapter and one onboard Intel 8255x-based PCI Ethernet adapter. On each client the Intel Ethernet adapter was connected to the RTE machines through a 10/100 BaseT switch and the Intel Pro NIC was connected to the Database Server through a crossover cable. The client was driven through 12 network segments. 760 emulated users were run on each network segment for a total of 9,120 emulated users. The network segments between the switches and RTEs were fixed at 10 Mbit/sec, half duplex.

General Items

Test Sponsor

A statement identifying the sponsor of the Benchmark and any other companies who have participated.

Dell was the test sponsor of this TPC Benchmark™ C.

Application Code and Definition Statements

The application program must be disclosed. This includes, but is not limited to, the code implementing the five transactions and the terminal input/output functions.

The application consists of the Microsoft Benchcraft Remote Terminal Emulator (RTE) program emulating a set of users entering TPC-C transactions through web browsers, and communicating with the Client machine running the Microsoft Internet Information Server (IIS) web server. The Client machine use the COM+ transaction monitor to communicate with the database server machine.

On the Client machine, IIS loads a custom Microsoft Internet Information Server Application Programming Interface dynamic link library (ISAPI DLL) application program that communicates with the emulated web browsers through the HTTP protocol and with the database server through the COM+ transaction monitor and the Microsoft DBLIB interface. The application supplies fill-in screens to the user for each transaction, then parses the data in each request, and makes a call on SQL Server through the COM+ layer, which manages a set of DBLIB connections to the database server. The resulting data is passed back to the application where it is formatted into HTML and sent back to the user's browser. The Delivery transaction is handled directly from the application to the database without the use of COM+.

The web Client code is listed in Appendix A.

Parameter Settings

Settings must be provided for all customer-tunable parameters and options which have been changed from the default found in actual products; including but not limited to:

- *Database options*
- *Recover/commit options*
- *Consistency/locking options*
- *System parameter, application parameters, and configuration parameters.*

This requirement can be satisfied by providing a full listing of all parameters and options.

Appendix C contains all the database, Windows 2000 Server, and Internet Information Service parameters used in this benchmark.

Appendix D contains the 60 day space calculations.

Configuration Diagrams

Diagrams of both the measured and priced system must be provided, accompanied by a description of the differences.

Figures 1 and 2 respectively show the measured and priced full client/server configurations. The system under test (SUT) in the measured system was identical to what was priced.

Figure 1: Measured Configuration

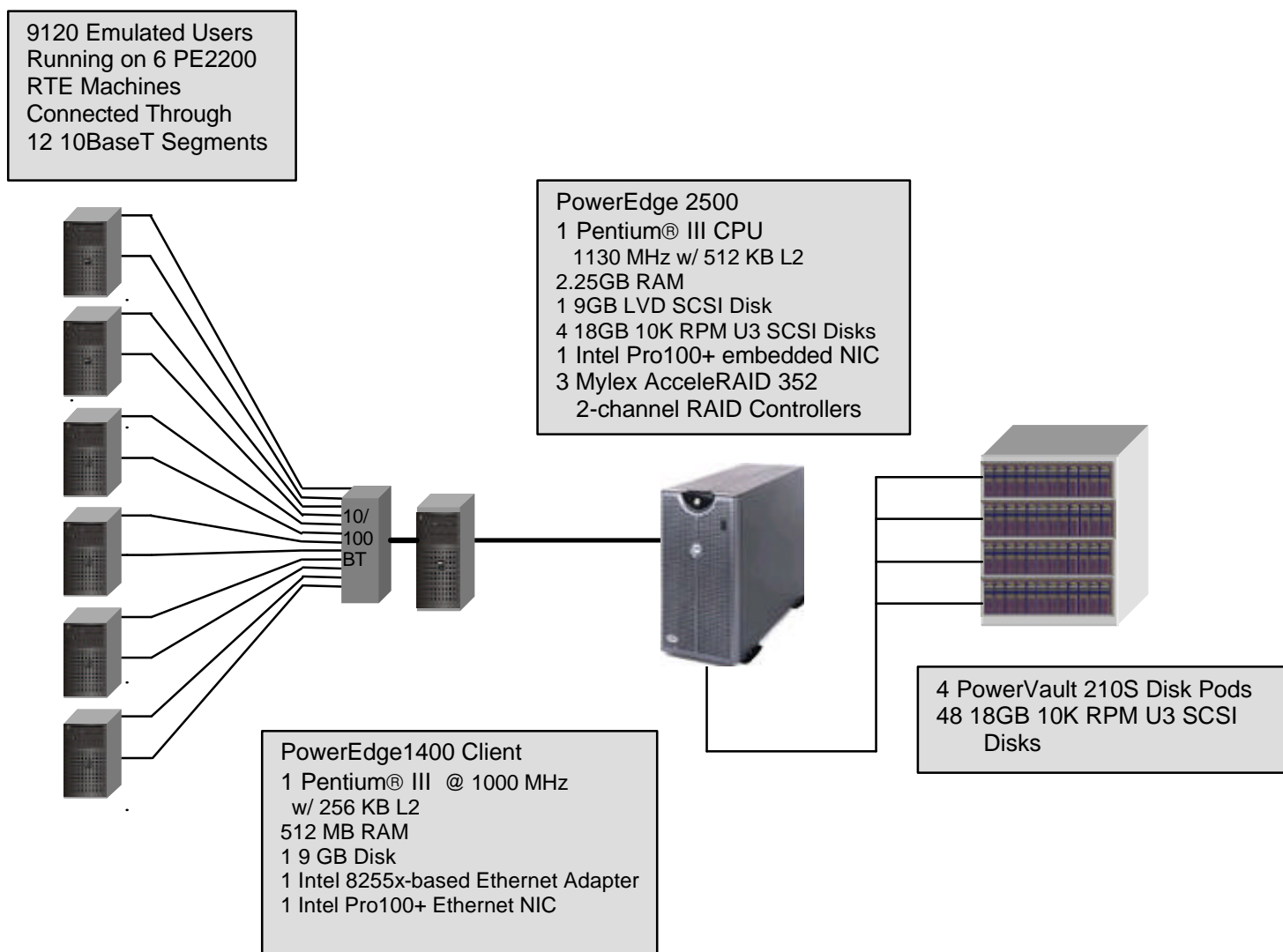
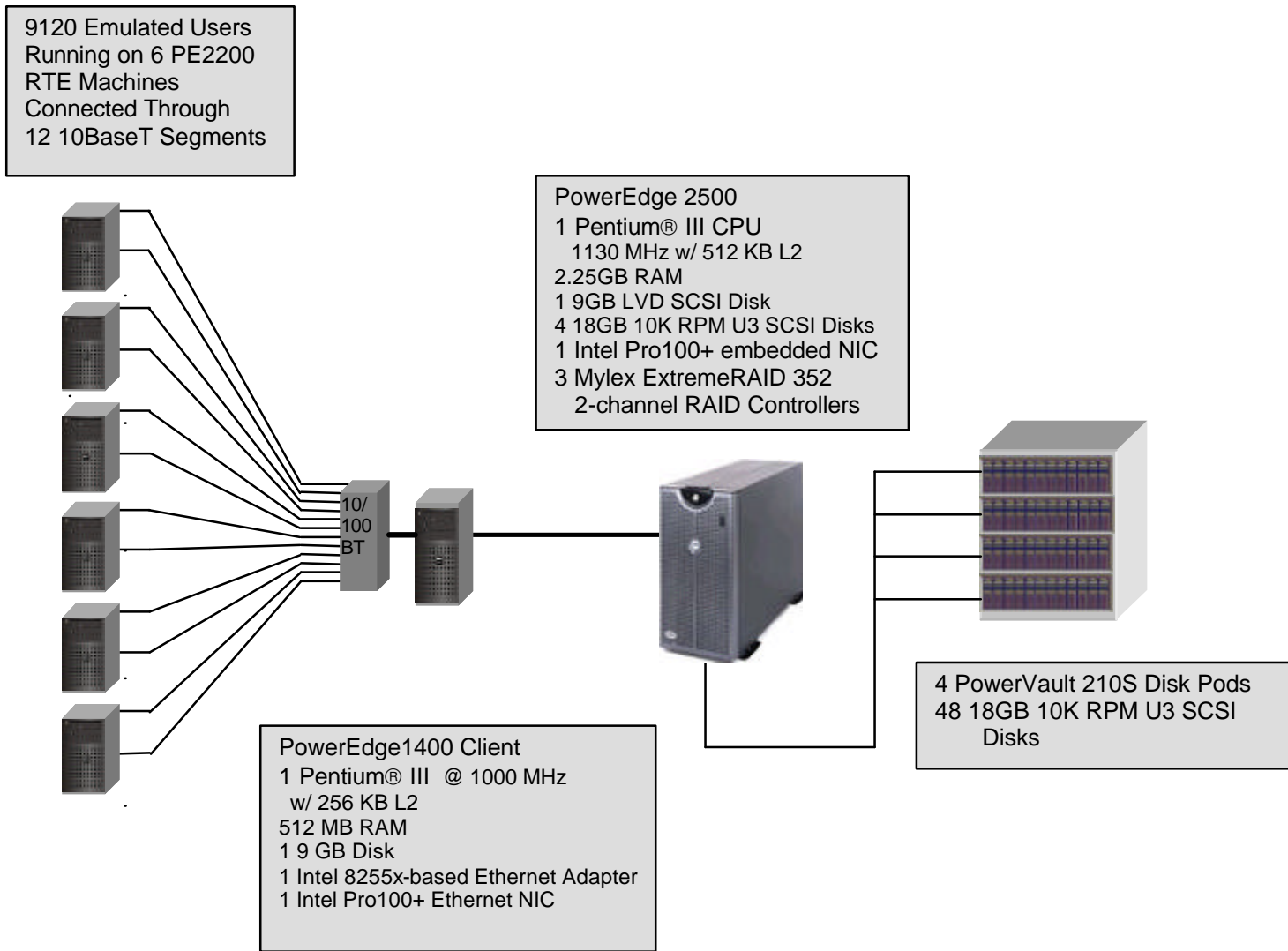

Figure 2: Priced Configuration



Clause 1 -- Logical Database Design Related Items

Table Definitions

Listings must be provided for all table definition statements and all other statements used to set-up the database. (8.1.2.1)

Appendix B contains the code used to define and load the database tables.

Physical Organization of the Database

The physical organization of tables and indices, within the database, must be disclosed. (8.1.2.2)

The measured configuration used 53 disk drives. The organization is shown in Table 5: Data Distribution.

Insert and Delete Operations

It must be ascertained that insert and/or delete operations to any of the tables can occur concurrently with the TPC-C transaction mix. Furthermore, any restriction in the SUT database implementation that precludes inserts beyond the limits defined in Clause 1.4.11 must be disclosed. This includes the maximum number of rows that can be inserted and the maximum key value for these new rows. (8.1.2.3)

Insert and delete functionality was fully operational during the benchmark.

Horizontal and Vertical Partitioning

While there are a few restrictions placed upon horizontal or vertical partitioning of tables and rows in the TPC-C benchmark (see Clause 1.6), any such partitioning must be disclosed. (8.1.2.4)

Partitioning was not used in this benchmark.

Replication

Replication of tables, if used, must be disclosed (see Clause 1.4.6). (8.1.2.5)

Replication was not used in this benchmark.

Table Attributes

Additional and/or duplicated attributes in any table must be disclosed along with a statement on the impact on performance (see Clause 1.4.7). (8.1.2.6)

No additional attributes were used in this benchmark.

Clause 2 -- Transaction and Terminal Profiles Related Items

Random Number Generation

The method of verification for the random number generation must be described. (8.1.3.1)

The random number generation was done internal to the Microsoft BenchCraft RTE program, which was audited independently.

Screen Layout

The actual layouts of the terminal input/output screens must be disclosed. (8.1.3.2)

The screen layouts are based on those in Clauses 2.4.3, 2.5.3, 2.6.3, 2.7.3, and 2.8.3 of the TPC-C Standard Specification. There are some very minor differences based on the fact that this is a web client implementation.

Terminal Verification

The method used to verify that the emulated terminals provide all the features described in Clause 2.2.2.4 must be explained. Although not specifically priced, the type and model of the terminals used for the demonstration in 8.1.3.3 must be disclosed and commercially available (including supporting software and maintenance). (8.1.3.3)

The terminal features were verified by allowing the auditor to manually execute each of the five transaction types, using Microsoft Internet Explorer version 3.0.

Intelligent Terminals

Any usage of presentation managers or intelligent terminals must be explained. (8.1.3.4)

Comment 1: *The intent of this clause is to describe any special manipulations performed by a local terminal or workstation to off-load work from the SUT. This includes, but is not limited to: screen presentations, message bundling, and local storage of TPC-C rows.*

Comment 2: *This disclosure also requires that all data manipulation functions performed by the local terminal to provide navigational aids for transaction(s) must also be described. Within this disclosure, the purpose of such additional function(s) must be explained.*

Application code involved in the manipulation of data was run on the client. Screen manipulation commands in the form of HTML were downloaded to the web browser, which handled input and output presentation graphics. A listing of this code is included in Appendix A. Microsoft Internet Information Service assisted in the processing and presentation of this data.

Transaction Profiles

The percentage of home and remote order-lines in the New-Order transactions must be disclosed. (8.1.3.5)

The percentage of New-Order transactions that were rolled back as a result of an unused item number must be disclosed. (8.1.3.6)

The number of items per orders entered by New-Order transactions must be disclosed. (8.1.3.7)

The percentage of home and remote Payment transactions must be disclosed. (8.1.3.8)

The percentage of Payment and Order-Status transactions that used non-primary key (C_LAST) access to the database must be disclosed. (8.1.3.9)

The percentage of Delivery transactions that were skipped as a result of an insufficient number of rows in the NEW-ORDER table must be disclosed. (8.1.3.10)

Table 1: Transaction Statistics

Transaction	Function	Value
New Order	Home Warehouse Items	99.00%
	Remote Warehouse Items	1.00%
	Rolled Back Transactions	0.99%
	Average Lines Per Order	10.00
Payment	Home Warehouse	84.96%
	Remote Warehouse	15.04%
	Non-Primary Key Access	60.02%
Order Status	Non-Primary Key Access	60.12%
Delivery	Skipped Transactions	0

Transaction Mix

The mix (i.e., percentages) of transaction types seen by the SUT must be disclosed. (8.1.3.11)

Table 2: Transaction Mix

Transaction	Percentage
New Order	44.85%
Payment	43.02%
Order Status	4.04%
Delivery	4.05%
Stock Level	4.04%

Deferred Delivery Mechanism

The queuing mechanism used to defer the execution of the Delivery transaction must be disclosed. (8.1.3.12)

The application creates a semaphore-base thread pool consisting of a user-specified number of threads, which open DBLIB connections on the database. When a Delivery transaction is posted one of these threads makes the database call while the transaction's original thread returns control to the user. Upon completion the Delivery thread writes an entry in the Delivery log and returns to the thread pool.

The source code is listed in Appendix A.

Clause 3 -- Transaction and System Properties Related Items

ACID Tests

The results of the ACID tests must be disclosed along with a description of how the ACID requirements were met. This includes disclosing which case was followed for the execution of Isolation Test 7. (8.1.4.1)

All ACID property tests were successful. The executions are described below.

Atomicity

The system under test must guarantee that the database transactions are atomic; the system will either perform all individual operations on the data or will assure that no partially completed operations leave any effects on the data.

Completed Transactions

A row was selected in a script from the warehouse, district and customer tables, and the balances noted. A payment transaction was started with the same warehouse, district and customer identifiers and a known amount. The payment transaction was committed and the rows were verified to contain correctly updated balances.

Aborted Transactions

A row was selected in a script from the warehouse, district and customer tables, and the balances noted. A payment transaction was started with the same warehouse, district and customer identifiers and a known amount. The payment transaction was rolled back and the rows were verified to contain the original balances.

Consistency

Consistency is the property of the application that requires any execution of a database transaction to take the database from one consistent state to another, assuming that the database is initially in a consistent state.

Consistency conditions one through four were tested using a shell script to issue queries to the database. The results of the queries verified that the database was consistent for all four tests. A run was executed under full load lasting over ten (10) minutes and included a checkpoint. The shell script was executed again. The result of the same queries verified that the database remained consistent after the run.

Isolation

Sufficient conditions must be enabled at either the system or application level to ensure the required isolation defined above (clause 3.4.1) is obtained.

Isolation tests one through seven were executed using shell scripts to issue queries to the database. Each script included timestamps to demonstrate the concurrency of operations. The results of the queries were captured to files. The captured files were verified by the auditor to demonstrate the required isolation had been met.

In addition, the phantom tests and the stock level tests were executed and verified.

For Isolation test seven, case A was followed.

Durability

The tested system must guarantee durability: the ability to preserve the effects of committed transactions and insure database consistency after recovery from any one of the failures listed in Clause 3.5.3.

Durable Media Failure

For convenience, durability from media failure was demonstrated on a 10 Warehouse database having similar characteristics to the fully scaled database. The standard driving mechanism was used to generate the transaction load of 100 users for the Loss of Data. The fully scaled database under full load would also have passed the following test.

Loss of Data

Loss of data was demonstrated on the full database with 1100 warehouses. The standard driving mechanism was used to generate the transaction load of 9120 users for the test. To demonstrate recovery from a permanent failure of durable media containing TPC-C tables, the following steps were executed:

1. The database was backed up using SQL Server backup facilities.
2. A sum of D_NEXT_O_ID was taken.
3. 9120 users were logged in to the database and ran transactions.
4. One disk drive in the data array was removed causing SQL Server errors.
5. The RTE was allowed to continue running. Completed transactions enroute from the clients were recorded. Error messages began appearing on the RTE screen.
6. The RTE was stopped.
7. SQL Server was stopped and restarted and a dump of the transaction log was taken.
8. SQL Server was stopped, Windows 2000 was shutdown and the machine powered off.
9. The failed disk was replaced.
10. The machine was powered up, Windows 2000 and SQL Server were started.
11. The TPC-C database was dropped and restored from backup.
12. The transaction log was restored and transactions rolled forward.
13. A new count of D_NEXT_O_ID was taken.
15. This number was compared with the number of new orders reported by the RTE.

Instantaneous Interruption and Loss of Memory/Loss of Log

Instantaneous Interruption and Loss of Memory were demonstrated on the full database with 1100 warehouses in a single test. The standard driving mechanism was used to generate the transaction load of 9,120 users for the test. To demonstrate recovery, an instantaneous system interruption was caused by powering off the Server, and the following steps were executed:

1. The full database was used.
2. A sum of D_NEXT_O_ID was taken.
3. 9,120 users were logged in to the database and ran transactions.
4. The system was run in steady state for 5 minutes
5. One disk drive in the transaction log array was removed with no effect on Windows 2000 or SQL Server.
6. The system ran for an additional 5 minutes.
6. The Server was powered off by normal means, causing instantaneous interruption.

7. The RTE was allowed to continue running. Completed transactions enroute from the clients were recorded. Error messages began appearing on the RTE screen.
8. The RTE was stopped.
9. The server was powered on again and rebooted.
10. SQL Server was restarted and automatically recovered.
11. A new count of D_NEXT_O_ID was taken.
12. This number was compared with the number of new orders reported by the RTE

Clause 4 -- Scaling and Database Population Related Items

Table Cardinality

The cardinality (e.g., the number of rows) of each table, as it existed at the start of the benchmark run (see Clause 4.2), must be disclosed. If the database was over-scaled and inactive rows of the WAREHOUSE table were deleted (see Clause 4.2.2), the cardinality of the WAREHOUSE table as initially configured and the number of rows deleted must be disclosed. (8.1.5.1)

The database was originally built with 1100 warehouses. The performance run used 912 warehouses and this is verified by runcheck

Table 3: Table Cardinality

Table	Cardinality as Benchmarked
Warehouse	1,100
District	11,000
Customer	33,000,000
History	33,000,000
NewOrder	9,900,000
Orders	33,000,000
OrderLine	329,998,919
Item	100,000
Stock	110,000,000
Deleted Warehouses	0

Constant Values

The following values were used as constant value inputs to the NURand function for this benchmark.

Table 4: Constant Values

Function	Constant C Value
C_LAST (Build)	123
C_LAST (Run)	208

Data Distribution

The distribution of tables and logs across all media must be explicitly depicted for the tested and priced systems. (8.1.5.2)

The Database was built using a total of 53 disks: 48 18 GB for data, 4 18 GB for log, and 1 9GB for OS and application software. The data drives were configured as hardware RAID 0. Logs were configured as hardware RAID 10. Mylex ExtremeRAID 2000 RAID Controller 2 was configured with 48 disk drives in a single logical drive. Mylex ExtremeRAID 2000 RAID Controller 1 contained 4 18GB drives. Each Windows 2000 data drive contained 3 partitions: partition 1 for customer/stock, partition 2 for miscellaneous, and partition 3 for backup. Partitions 1 and 2 were RAW file systems and partition 3 was formatted NTFS. The details are shown in Table 5.

Table 5: Data Distribution

W2K Disk Administration		Adaptec 7899 Configuration			
Disk 0 8673MB		On-Board Controller # 1			
Partition	On-Board	Channels			
1	Internal	SCSI ID	0		
C: OS NTFS 8673 MB			0 A0-1		
			1		
			2		
			3		

W2K Disk Administration		MYLEX AcceleRAID 352 Configuration			
Disk 1 34320MB		Controller # 1			
Partition	Slot# 1	Channels			
1		SCSI ID	A	B	
S: LOG Unknown 34320MB		0	A1-1		
		1	A2-1		
		2			
		3		A1-2	
		4		A2-2	
		5			
		8			
		9			
		10			
		11			
		12			
		13			

W2K Disk Administration			MYLEX AcceleRAID 352 Configuration					
Disk 2 411840MB			Controller # 2					
Partition			Slot# 2		Channels			
1	2	3		SCSI ID	A	B		
E: CS1 Unknown 68096MB	F: MS1 Unknown 37888MB	X: NTFS 717690.8MB		0	A1-1	A2-1		
				1	A1-2	A2-2		
				2	A1-3	A2-3		
				3	A1-4	A2-4		
				4	A1-5	A2-5		
				5	A1-6	A2-6		
				8	A1-7	A2-7		
				9	A1-8	A2-8		
				10	A1-9	A2-9		
				11	A1-10	A2-10		
				12	A1-11	A2-11		
				13	A1-12	A2-12		

W2K Disk Administration			MYLEX EX2000P Configuration					
Disk 3 411840MB			Controller # 3					
Partition			Slot# 3		Channels			
1	2	3		SCSI ID	A	B		
G: CS1 Unknown 68096MB	H: MS1 Unknown 37888MB	Y: NTFS 717690.8MB		0	A1-1	A2-1		
				1	A1-2	A2-2		
				2	A1-3	A2-3		
				3	A1-4	A2-4		
				4	A1-5	A2-5		
				5	A1-6	A2-6		
				8	A1-7	A2-7		
				9	A1-8	A2-8		
				10	A1-9	A2-9		
				11	A1-10	A2-10		
				12	A1-11	A2-11		
				13	A1-12	A2-12		

Comment: Detailed diagrams for layout of database files on disks can widely vary, and it is difficult to provide exact guideline suitable for all implementations. The intent is to provide sufficient detail to allow independent reconstruction of the test database. The two figures below are examples of database layout descriptions and are not intended to depict or imply any optimal

layout for the TPC-C database.

8.1.5.3 A statement must be provided that describes:

1. The data model implemented by the DBMS used (e.g., relational, network, hierarchical)
2. The database interface (e.g., embedded, call level) and access language (e.g., SQL, DL/1, COBOL read/write) used to implement the TPC-C transactions. If more than one interface/access language is used to implement TPC-C, each interface/access language must be described and a list of which interface/access language is used with which transaction type must be disclosed.

Microsoft SQL Server 2000 Enterprise Edition is a relational DBMS.

The interface used was Microsoft SQL Server stored procedures accessed with Remote Procedure Calls embedded in C code using the Microsoft DBLIB interface.

Partition Mapping

The mapping of database partitions/replications must be explicitly described.

Comment: *The intent is to provide sufficient detail about partitioning and replication to allow independent reconstruction of the test database. (8.1.5.4)*

An description of a database partitioning scheme is presented below as an example. The nomenclature of this example was outlined using the CUSTOMER table (in Clause 8.1.2.1), and has been extended to use the ORDER and ORDER_LINE tables as well.

The database was not replicated.

60 day Space Calculation

Details of the 60 day space computations along with proof that the database is configured to sustain 8 hours of growth for the dynamic tables (Order, Order-Line, and History) must be disclosed (see Clause 4.2.3). (8.1.5.5)

To calculate the space required to sustain the database log for 8 hours of growth at steady state, the following steps were followed:

1. The current log space usage was determined by running *dbcc sqlperf(logspace)*
2. Transactions were run against the database with a full load of users.
3. The final log space usage was determined by running *dbcc sqlperf(logspace)*
4. The space used was calculated as the difference between the first and second query.
5. The number of NEW-ORDERS was verified from an RTE report covering the entire run.
6. The space used was divided by the number of NEW-ORDERS giving a space used per NEW-ORDER transaction.
7. The space used per transaction was multiplied by the measured tpmC rate times 480 minutes.

The results of the above steps yielded a requirement of 55.0193 GB (including mirror) to sustain the log for 8 hours. Space available on the transaction log volume was 67.03 GB (including mirror), indicating that enough storage was configured to sustain 8 hours of growth.

The same methodology was used to compute growth requirements for dynamic tables Order, Order-Line and History.

The details of the 180-day space requirement is shown in Appendix D.

Clause 5 -- Performance Metrics and Response Time Related Items

Measured TpmC

Measured tpmC must be reported. (8.1.6.1)

Measured TpmC 11314.11
 Price per TpmC \$4.38

Response Times

Ninetieth percentile, maximum and average response times must be reported for all transaction types as well as for the Menu response time. (8.1.6.2)

Table 6: Transaction Response Times

Transaction	Average	90%	Maximum
New Order	0.51	0.74	6.91
Payment	0.30	0.48	5.01
Order Status	0.38	0.58	8.07
Interactive Delivery	0.15	0.26	0.79
Deferred Delivery	0.71	1.19	2.48
Stock Level	3.19	4.32	9.93
Menu	0.15	0.27	0.97

Think Times & Key Times

The minimum, the average, and the maximum keying and think times must be reported for each transaction type. (8.1.6.3)

Table 7: Transaction Key Times

Transaction	Minimum	Average	Maximum
New Order	18.01	18.03	18.04
Payment	3.02	3.03	3.04
Order Status	2.02	2.03	2.04
Delivery	2.02	2.03	2.04
Stock Level	2.02	2.03	2.04

Table 8: Transaction Think Times

Transaction	Minimum	Average	Maximum
New Order	0.00	12.02	120.41
Payment	0.00	12.03	120.41
Order Status	0.00	10.05	100.40
Delivery	0.00	5.04	50.40
Stock Level	0.00	5.05	50.40

Response Time Distribution Curves

Response Time frequency distribution curves (see Clause 5.6.1) must be reported for each transaction type. (8.1.6.4)

Figure 2: New Order Response Time Distribution

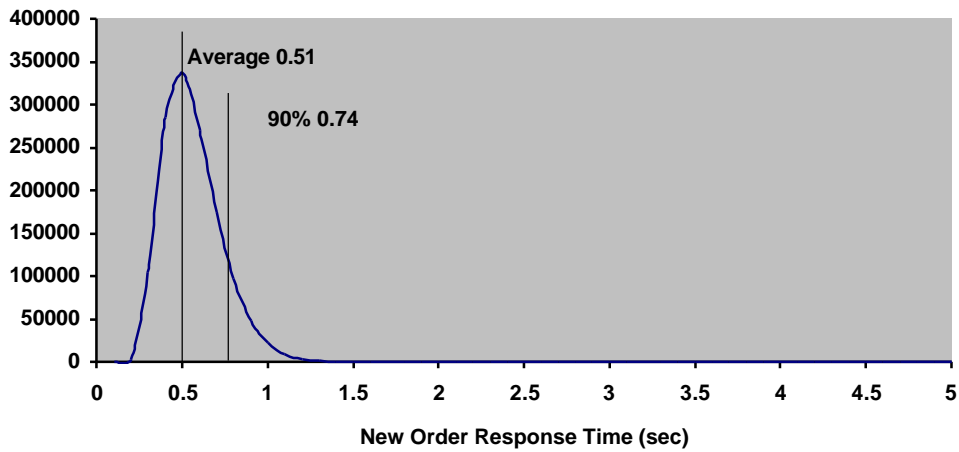

Figure 3: Payment Response Time Distribution

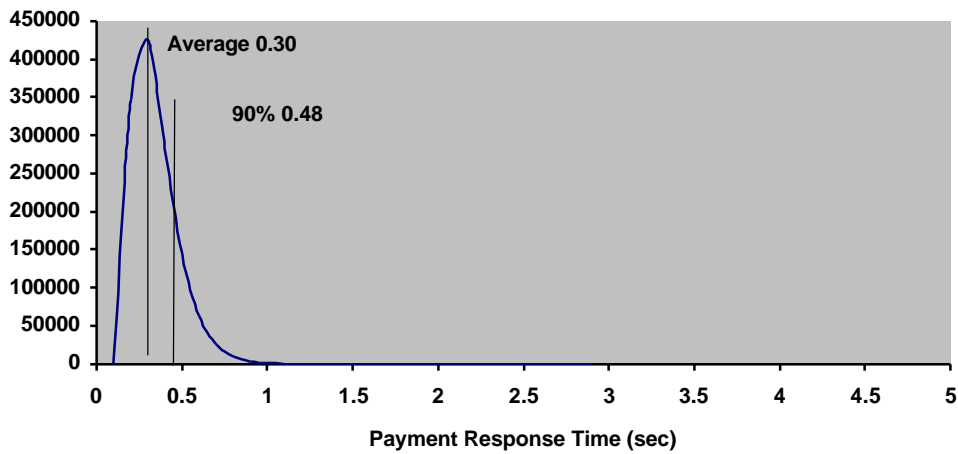

Figure 4: Order Status Response Time Distribution

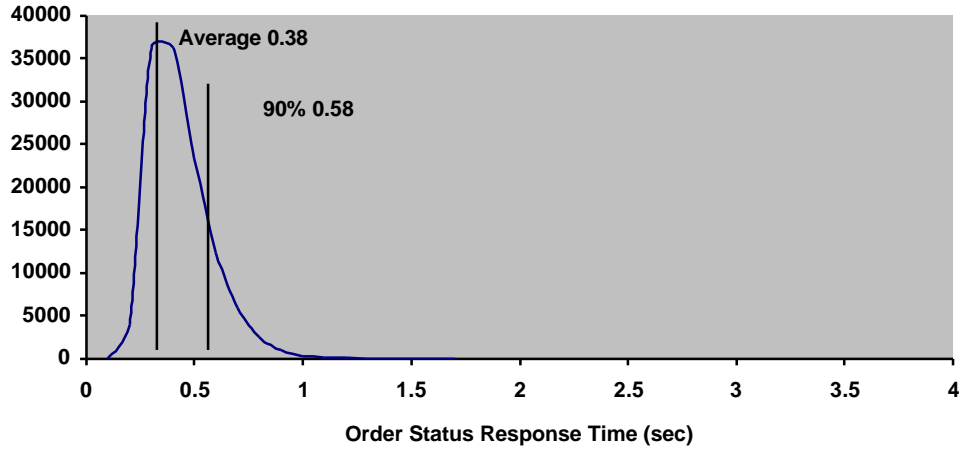

Figure 5: Delivery Response Time Distribution

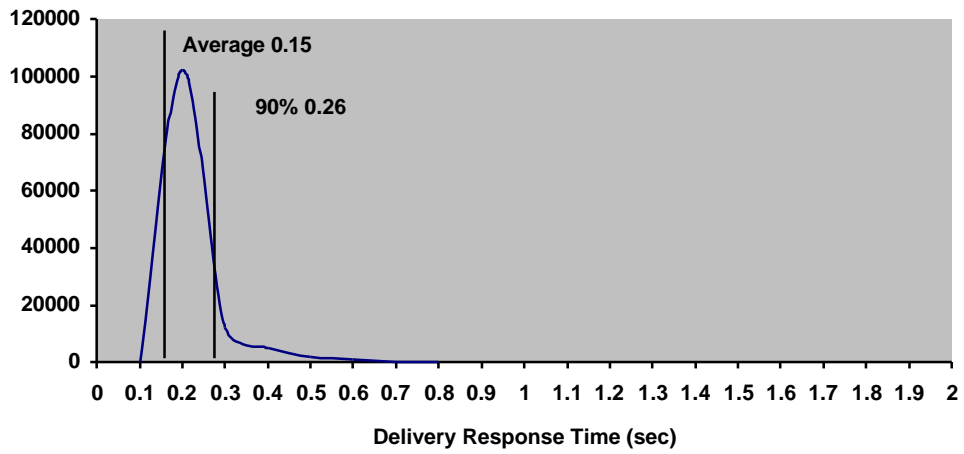
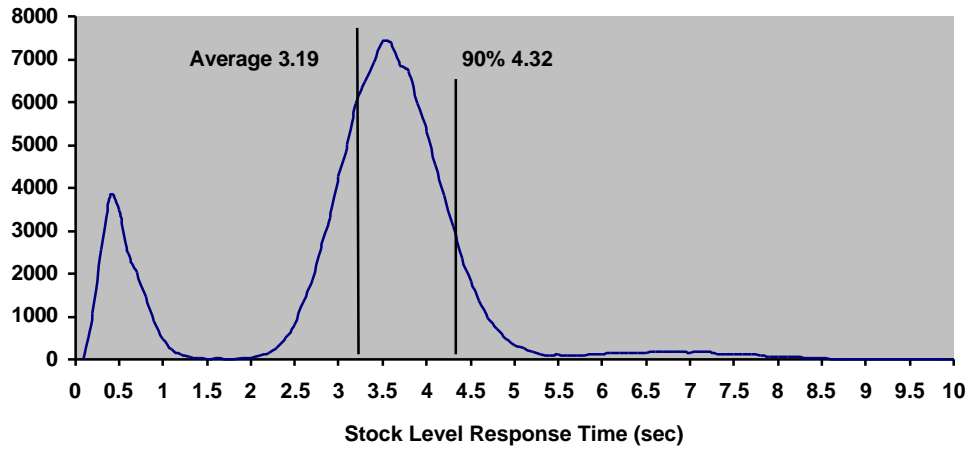

Figure 6: Stock Level Response Time Distribution



New-Order Response Time vs. Throughput Graph

The performance curve for response times versus throughput (see Clause 5.6.2) must be reported for the New-Order transaction. (8.1.6.5)

Figure 8: New Order Response Time vs. Throughput

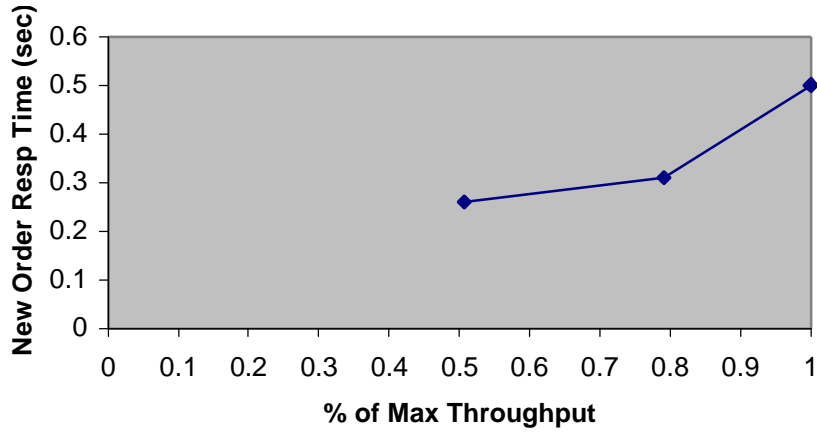

New-Order Think Time Distribution Graph

Think Time frequency distribution curves (see Clause 5.6.3) must be reported for the New-Order transaction (8.1.6.6)

Figure 9: New Order Think Time Distribution

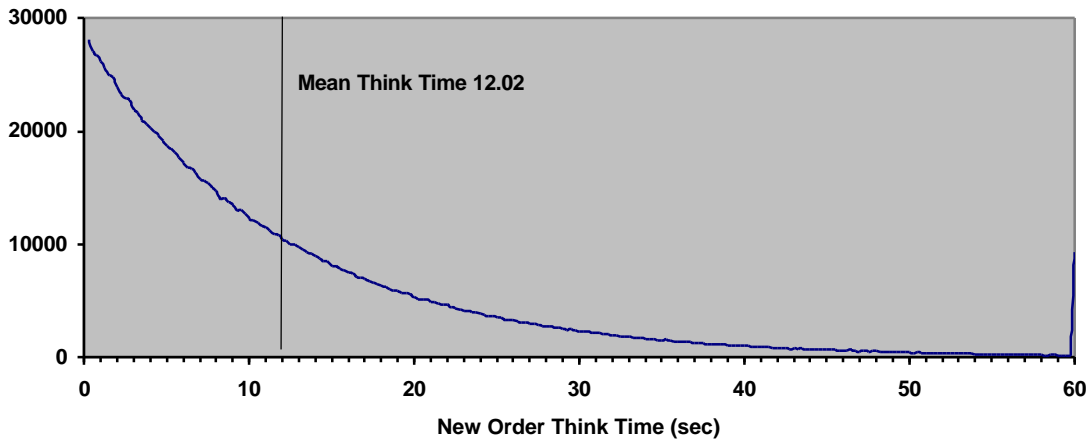

Steady-State Graph

A graph of throughput versus elapsed time (see Clause 5.6.5) must be reported for the New-Order transaction. (8.1.6.8)

Figure 10: New Order Throughput vs. Time

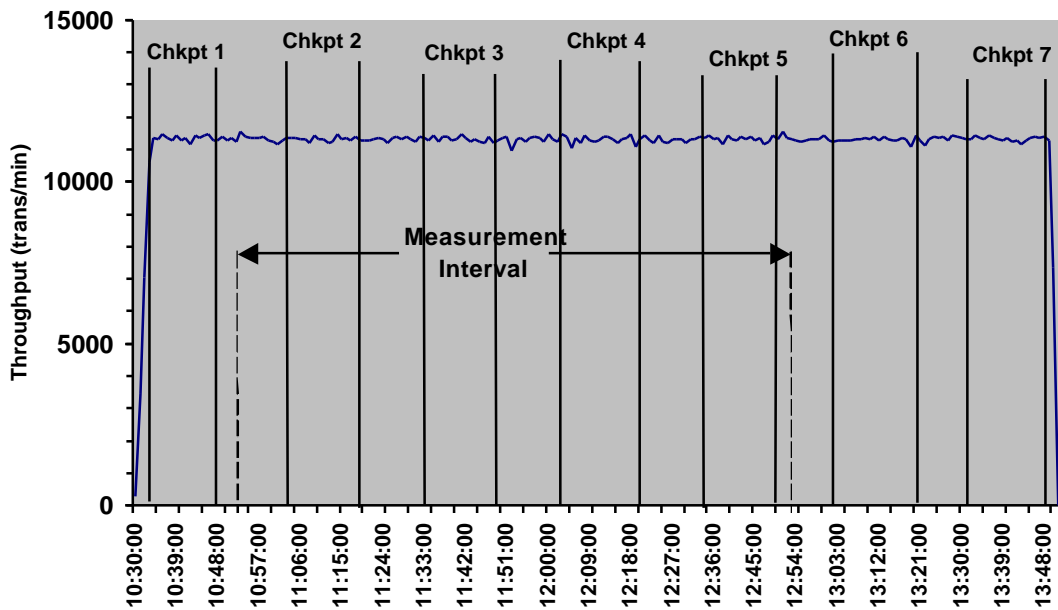

Steady-State Methodology

The method used to determine that the SUT had reached a steady state prior to commencing the measurement interval (see Clause 5.5) must be described. (8.1.6.9)

Steady state was determined using real time monitor utilities from both the operating system and the RTE. Steady state was further confirmed by the throughput data collected during the run and graphed in Figure 10.

Work Performed During Steady State

A description of how the work normally performed during a sustained test (for example checkpointing, writing redo/undo log records, etc.), actually occurred during the measurement interval must be reported. (8.1.6.10)

The RTE generated the required input data to choose a transaction from the menu. This data was timestamped. The menu response for the requested transaction was verified and timestamped in the RTE log files.

The RTE generated the required input data for the chosen transaction. It waited to complete the minimum required key time before transmitting the HTTP request to the client. The transmission was timestamped. The return of the screen with the required response data was timestamped. The difference between these two timestamps was the response time for that transaction and was logged in the RTE log.

The RTE then waited the required think time interval before repeating the process starting at selecting another transaction from the menu.

The RTE transmissions were sent to the web-based application program running on the client machines through Ethernet LANs. These web clients managed the emulated web browser interface as well as all requests to the database on the server. The applications communicated with the database server over another Ethernet LAN using the COM+ transaction monitor and Microsoft SQL Server DBLIB library and RPC calls.

To perform checkpoints at specific intervals, we set SQL Server *recovery interval* to the maximum allowable value and wrote a script to schedule multiple checkpoints at specific intervals. By setting the TRACE FLAG #3502, SQL Server logged the checkpoint beginning and ending time in the ERRORLOG file. The script included a wait time between each checkpoint equal to the measurement interval, which was 30 minutes. The checkpoint script was started manually after the RTE had all users logged in and sending transactions.

At each checkpoint, Microsoft SQL Server wrote to disk all memory pages that had been updated but not yet physically written to disk. Upon completion of the checkpoint, Microsoft SQL Server wrote a special record to the recovery log to indicate that all disk operations had been satisfied to this point.

Measurement Period Duration and Checkpoint Duration

The start time and duration in seconds of at least the four (4) longest checkpoints during the measurement interval must be disclosed (see clause 5.5.2.2(2)) (8.1.6.11)

A statement of the duration of the measurement interval for the reported Maximum Qualified Throughput (tpmC) must be included. (8.1.6.12)

	Start	End	Duration
Measurement Interval	10:53:17	12:53:17	7,200
1 st Checkpoint	11:04:08	11:19:71	909
2 nd Checkpoint	11:34:03	11:50:18	975
3 rd Checkpoint	12:03:59	12:20:13	974
4 th Checkpoint	12:33:54	12:50:02	968

Transaction Mix

8.1.6.13 The method of regulation of the transaction mix (e.g., card decks or weighted random distribution) must be described. If weighted distribution is used and the RTE adjusts the weights associated with each transaction type, the maximum adjustments to the weight from the initial value must be disclosed. (8.1.6.13)

The RTE was given a weighted random distribution that was not adjusted during the run.

The percentage of the total mix for each transaction type must be disclosed. (8.1.6.14)

Table 9: Transaction Mix

Transaction	Percentage
New Order	44.85%
Payment	43.02%
Order Status	4.04%
Delivery	4.04%
Stock Level	4.05%

Other Metrics

The percentage of New-Order transactions rolled back as a result of invalid item number must be disclosed. (8.1.6.15)

The average number of order-lines entered per New-Order transaction must be disclosed. (8.1.6.16)

The percentage of remote order-lines entered per New-Order transaction must be disclosed. (8.1.6.17)

The percentage of remote Payment transactions must be disclosed. (8.1.6.18)

The percentage of customer selections by customer last name in the Payment and Order-Status transactions must be disclosed. (8.1.6.19)

The percentage of Delivery transactions skipped due to there being fewer than necessary orders in the New-Order table must be disclosed. (8.1.6.20)

Table 10: Transaction Statistics

Transaction	Function	Value
New Order	Home Warehouse Items	99.00%
	Remote Warehouse Items	1.00%
	Rolled Back Transactions	1.00%
	Average Lines Per Order	10.00
Payment	Home Warehouse	84.96%
	Remote Warehouse	15.04%
	Non-Primary Key Access	60.02%
Order Status	Non-Primary Key Access	60.12%
Delivery	Skipped Transactions	0

Clause 6 -- SUT, Driver, and Communication Definition Related Items

RTE Parameters

The RTE input parameters, code fragments, functions, etc. used to generate each transaction input field must be disclosed. (8.1.7.1)

Comment: *The intent is to demonstrate the RTE was configured to generate transaction input data as specified in Clause 2.*

The RTE input parameters are listed in Appendix C - Tunable Parameters.

Emulated Components

It must be demonstrated that the functionality and performance of the components being emulated in the Driver System are equivalent to that of the priced system. The results of the test described in Clause 6.6.3.4 must be disclosed. (8.1.7.2)

No components were emulated.

Benchmarked and Targeted System Configuration Diagrams

A complete functional diagram of both the benchmark configuration and the configuration of the proposed (target) system must be disclosed. A detailed list of all software and hardware functionality being performed on the Driver System, and its interface to the SUT must be disclosed (see Clause 6.6.3.6). (8.1.7.3)

The driver system performed transaction data generation and communication to the client through the standard web browser (HTTP) protocol. It also captured and timestamped the SUT output data for post-processing of the reported metrics. No other functionality was included on the driver system.

Figures 1 & 2 of this report contain detailed diagrams of both the benchmark configuration and the priced configuration.

Network Configuration

The network configurations of both the tested services and the proposed (target) services which are being represented and a thorough explanation of exactly which parts of the proposed configuration are being replaced with the Driver System must be disclosed (see Clause 6.6.4). (8.1.7.4)

The network configurations of the benchmarked and priced configurations were identical.

Network Bandwidth

The bandwidth of the network(s) used in the tested/priced configuration must be disclosed. (8.1.7.5)

The bandwidth of the tested and priced networks were as follows:

- 10 BaseT (10 Mbit/sec) network segments between the RTE/Emulated Users and the switch.
- Cross-over cable between the Client and Server.

Operator Intervention

If the configuration requires operator intervention (see Clause 6.6.6), the mechanism and the frequency of this intervention must be disclosed. (8.1.7.6)

This configuration does not require any operator intervention to sustain eight hours of the reported throughput.

Clause 7 -- Pricing Related Items

Hardware and Software List

A detailed list of hardware and software used in the priced system must be reported. Each separately orderable item must have vendor part number, description, and release/revision level, and either general availability status or committed delivery date. If package-pricing is used, vendor part number of the package and a description uniquely identifying each of the components of the package must be disclosed.

Pricing source(s) and effective date(s) of price(s) must also be reported. (8.1.8.1)

The total 5-year price of the entire configuration must be reported, including: hardware, software, and maintenance charges. Separate component pricing is recommended. The basis of all discounts used must be disclosed. (8.1.8.2)

The details of the hardware and software are reported in the front of this report as part of the executive summary. All third party quotations are included at the end of this report as Appendix E.

Availability Date

The committed delivery date for general availability (availability date) of products used in the price calculations must be reported. When the priced system includes products with different availability dates, the reported availability date for the priced system must be the date at which all components are committed to be available. (8.1.8.3)

Hardware Availability Date: DEC 14, 2001

Software Availability Date: DEC 14, 2001

Measured TpmC

A statement of the measured tpmC, as well as the respective calculations for 5-year pricing, price/performance (price/tpmC), and the availability date must be included. (8.1.8.4)

Maximum Qualified Throughput: 11,314.11 tpmC

Price Performance Metric: \$4.38

Country Specific Pricing

Additional Clause 7 related items may be included in the Full Disclosure Report for each country specific priced configuration. Country specific pricing is subject to Clause 7.1.7. (8.1.8.5)

This system is priced for the United States of America.

Usage Pricing

For any usage pricing, the sponsor must disclose (8.1.8.6):

- *Usage level at which the component was priced.*
- *A statement of the company policy allowing such pricing.*

Comment: *Usage pricing may include, but is not limited to, the operating system and database management software.*

The component pricing based on usage is shown below:

- 2 Microsoft Windows 2000 Server Licenses
- 1 Microsoft SQL Server 2000 Standard Edition License.
- 1 Microsoft Visual C++ 32 bit Edition
- 3 Year Support for Hardware Components.

System Pricing

System pricing should include subtotals for the following components: Server Hardware, Server Software, Client Hardware, Client Software, and Network Components used for terminal connection (see Clause 7.2.2.3). Clause 6.1 describes the Server and Client components. An example of the standard pricing sheet is shown in Appendix B. (8.1.8.7)

System pricing must include line item indication where non-sponsoring companies' brands are used. System pricing must also include line item indication of third party pricing. See example in Appendix B. (8.1.8.8)

The details of the hardware and software are reported in the front of this report as part of the executive summary. All third party quotations are included at the end of this report as Appendix E.

Clause 9 -- Audit Related Items

Auditor

The auditor's name, address, phone number, and a copy of the auditor's attestation letter indicating compliance must be included in the Full Disclosure Report. (8.1.9.1)

A review of the pricing model is required to ensure that all components required are priced (see Clause 9.2.8). The auditor is not required to review the final Full Disclosure Report or the final pricing prior to issuing the attestations letter. (8.1.9.2)

This TPC-C benchmark has been audited by Lorna Livingtree of Performance Metrics.

Availability of the Full Disclosure Report

The Full Disclosure Report must be readily available to the public at a reasonable charge, similar to the charges for similar documents by the test sponsor. The report must be made available when results are made public. In order to use the phrase "TPC Benchmark™ C", the Full Disclosure Report must have been submitted to the TPC Administrator as well as written permission obtained to distribute same.

Requests for this TPC Benchmark C Full Disclosure Report should be sent to:

Transaction Processing Performance Council
c/o Shanley Public Relations
777 North First Street, Suite 6000
San Jose, CA 95112-6311
www.tpc.org

or:

Dell
One Dell Way
Round Rock, TX 78682
Attention: Mike Molloy

Auditor's Letter of Attestation

December 10, 2001

Mike Molloy
Senior Manager, Server Performance Analysis
Dell Computer Corporation
One Dell Way
Round Rock, TX 78682

I have verified by remote the TPC Benchmark™ C for the following configuration:

Platform: PowerEdge 2500
Database Manager: Microsoft SQL Server 2000 Standard Edition
Operating System: Microsoft Windows 2000 Server
Transaction Monitor: Microsoft COM+

Servers:				
CPU's	Memory	Disks (total)	90% Response	TpmC
1 Pentium III Xeon @ 1.13 Ghz	Main: 2.256 GB Cache: 512KB	1 @ 9.1GB (OS) 52 @ 18GB	0.74	11,314.11
1 Client:				
1 Pentium III Xeon @ 1 Ghz	Main: 512 MB Cache: 256K	1 @ 9.1GB	Na	Na

In my opinion, these performance results were produced in compliance with the TPC requirements for the benchmark. The following attributes of the benchmark were given special attention:

- The transactions were correctly implemented.
- The database files were properly sized and populated.
- The database was properly scaled with 1100 warehouses of which 912 were active during the measured interval.
- The ACID properties were successfully demonstrated.
- Log loss and data loss durability were demonstrated on the full SUT.
- Input data was generated according to the specified percentages.
- Eight hours of mirrored log space was present on the tested system.
- Eight hours of growth space for the dynamic tables was present on the tested system.
- The data for the 60 day space calculation was verified.
- The controller cache was disabled on the log controller.

- The steady state portion of the test was 120 minutes.
- One checkpoint was taken before the measured interval.
- Four checkpoints were taken during the measured interval.

Auditor Notes:

None.

Sincerely,

A handwritten signature in cursive script that reads "Lorna Livingtree".

Lorna Livingtree
Auditor

Appendix A - Application Source Code

Appendix A - Application Source Code

tpcc.dll ISAPI DLL Source Code

isapi_dll/src/tpcc.def

```
LIBRARY TPCC.DLL

EXPORTS

    GetExtensionVersion@1
    HttpExtensionProc @2
    TerminateExtension@3
```

Isapi_dll/src/tpcc.h

```
/*      FILE:          TPCC.H
 *
 *      Microsoft TPC-C Kit Ver. 4.20.000
 *      Copyright Microsoft, 1999
 *
 *      All Rights Reserved
 *
 *      Version 4.10.000 audited by Richard Gimarc,
 *      Performance Metrics, 3/17/99
 *
 *      PURPOSE: Header file for ISAPI TPCC.DLL, defines structures and functions used
 *      in the isapi tpcc.dll.
 *
 */

//VERSION RESOURCE DEFINES
#define _APS_NEXT_RESOURCE_VALUE          101
#define _APS_NEXT_COMMAND_VALUE          40001
#define _APS_NEXT_CONTROL_VALUE          1000
#define _APS_NEXT_SYMED_VALUE            101

#define TP_MAX_RETRIES
    50

//note that the welcome form must be processed first as terminal ids assigned here, once
the
//terminal id is assigned then the forms can be processed in any order.
#define WELCOME_FORM                        1
    //beginning form no term id assigned, form id
```

```
#define MAIN_MENU_FORM                      2
    //term id assigned main menu form id
#define NEW_ORDER_FORM                      3
    //new order form id
#define PAYMENT_FORM                        4
    //payment form id
#define DELIVERY_FORM                       5
    //delivery form id
#define ORDER_STATUS_FORM                   6
    //order status id
#define STOCK_LEVEL_FORM                    7
    //stock level form id

//This macro is used to prevent the compiler error unused formal parameter
#define UNUSEDPARAM(x) (x = x)

//This structure defines the data necessary to keep distinct for each terminal or client
connection.
typedef struct _CLIENTDATA
{
    int                iNextFree;
    //index of next free element or -1 if this entry in use.
    int                w_id;
    //warehouse id assigned at welcome form
    int                d_id;
    //district id assigned at welcome form

    int                iSyncId;
    //synchronization id
    int                iTickCount;
    //time of last access;

    CTPCC_BASE        *pTxn;
} CLIENTDATA, *PCLIENTDATA;

//This structure is used to define the operational interface for terminal id support
typedef struct _TERM
{
    int                iNumEntries;
    //total allocated terminal array entries
    int                iFreeList;
    //next available terminal array element or -1 if none
    int                iMasterSyncId;
    //synchronization id
    CLIENTDATA        *pClientData;
    //pointer to allocated client data
} TERM;

typedef TERM *PTERM;
    //pointer to terminal structure type

enum WEBERROR
{
    NO_ERR,
    ERR_COMMAND_UNDEFINED,
    ERR_D_ID_INVALID,
    ERR_DELIVERY_CARRIER_ID_RANGE,
    ERR_DELIVERY_CARRIER_INVALID,
    ERR_DELIVERY_MISSING_OCD_KEY,
```

Appendix A - Application Source Code

```
ERR_DELIVERY_THREAD_FAILED,
ERR_GETPROCADDR_FAILED,
ERR_HTML_ILL_FORMED,
ERR_INVALID_SYNC_CONNECTION,
ERR_INVALID_TERMID,
ERR_LOADDLL_FAILED,
ERR_MAX_CONNECTIONS_EXCEEDED,
ERR_MEM_ALLOC_FAILED,
ERR_MISSING_REGISTRY_ENTRIES,
ERR_NEWORDER_CUSTOMER_INVALID,
ERR_NEWORDER_CUSTOMER_KEY,
ERR_NEWORDER_DISTRICT_INVALID,
ERR_NEWORDER_FORM_MISSING_DID,
ERR_NEWORDER_ITEMID_INVALID,
ERR_NEWORDER_ITEMID_RANGE,
ERR_NEWORDER_ITEMID_WITHOUT_SUPPW,
ERR_NEWORDER_MISSING_IID_KEY,
ERR_NEWORDER_MISSING_QTY_KEY,
ERR_NEWORDER_MISSING_SUPPW_KEY,
ERR_NEWORDER_NOITEMS_ENTERED,
ERR_NEWORDER_QTY_INVALID,
ERR_NEWORDER_QTY_RANGE,
ERR_NEWORDER_QTY_WITHOUT_SUPPW,
ERR_NEWORDER_SUPPW_INVALID,
ERR_NO_SERVER_SPECIFIED,
ERR_ORDERSTATUS_CID_AND_CLT,
ERR_ORDERSTATUS_CID_INVALID,
ERR_ORDERSTATUS_CLT_RANGE,
ERR_ORDERSTATUS_DID_INVALID,
ERR_ORDERSTATUS_MISSING_CID_CLT,
ERR_ORDERSTATUS_MISSING_CID_KEY,
ERR_ORDERSTATUS_MISSING_CLT_KEY,
ERR_ORDERSTATUS_MISSING_DID_KEY,
ERR_PAYMENT_CDI_INVALID,
ERR_PAYMENT_CID_AND_CLT,
ERR_PAYMENT_CUSTOMER_INVALID,
ERR_PAYMENT_CWI_INVALID,
ERR_PAYMENT_DISTRICT_INVALID,
ERR_PAYMENT_HAM_INVALID,
ERR_PAYMENT_HAM_RANGE,
ERR_PAYMENT_LAST_NAME_TO_LONG,
ERR_PAYMENT_MISSING_CDI_KEY,
ERR_PAYMENT_MISSING_CID_CLT,
ERR_PAYMENT_MISSING_CID_KEY,
ERR_PAYMENT_MISSING_CLT,
ERR_PAYMENT_MISSING_CLT_KEY,
ERR_PAYMENT_MISSING_CWI_KEY,
ERR_PAYMENT_MISSING_DID_KEY,
ERR_PAYMENT_MISSING_HAM_KEY,
ERR_STOCKLEVEL_MISSING_THRESHOLD_KEY,
ERR_STOCKLEVEL_THRESHOLD_INVALID,
ERR_STOCKLEVEL_THRESHOLD_RANGE,
ERR_VERSION_MISMATCH,
ERR_W_ID_INVALID
};

class CWEBCLNT_ERR : public CBaseErr
{
public:
    CWEBCLNT_ERR(WEBERROR Err)
    {
        m_Error = Err;
    }
};

m_szTextDetail = NULL;
m_SystemErr = 0;
m_szErrorText = NULL;
};

CWEBCLNT_ERR(WEBERROR Err, char *szTextDetail, DWORD dwSystemErr)
{
    m_Error = Err;
    m_szTextDetail = new char[strlen(szTextDetail)+1];
    strcpy( m_szTextDetail, szTextDetail );
    m_SystemErr = dwSystemErr;
    m_szErrorText = NULL;
};

~CWEBCLNT_ERR()
{
    if (m_szTextDetail != NULL)
        delete [] m_szTextDetail;
    if (m_szErrorText != NULL)
        delete [] m_szErrorText;
};

WEBERROR m_Error;
char *m_szTextDetail; //
char *m_szErrorText;
DWORD m_SystemErr;

int ErrorType() {return ERR_TYPE_WEBDLL;};
int ErrorNum() {return m_Error;};
char *ErrorText();
};

//These constants have already been defined in engstut.h, but since we do
//not want to include it in the delisrv executable
#define TXN_EVENT_START 2
#define TXN_EVENT_STOP 4
#define TXN_EVENT_WARNING 6 //used to record a warning into the log

//function prototypes

BOOL APIENTRY DllMain(HANDLE hModule, DWORD ul_reason_for_call, LPVOID lpReserved);
void WriteMessageToEventLog(LPTSTR lpszMsg);
void ProcessQueryString(EXTENSION_CONTROL_BLOCK *pECB, int *pCmd, int *pFormId, int *pTermId, int *pSyncId);
void WelcomeForm(EXTENSION_CONTROL_BLOCK *pECB, char *szBuffer);
void SubmitCmd(EXTENSION_CONTROL_BLOCK *pECB, char *szBuffer);
void BeginCmd(EXTENSION_CONTROL_BLOCK *pECB, int iFormId, int iTermId);
void ProcessCmd(EXTENSION_CONTROL_BLOCK *pECB, int iFormId, int iTermId);
void StatsCmd(EXTENSION_CONTROL_BLOCK *pECB, char *szBuffer);
void ErrorMessage(EXTENSION_CONTROL_BLOCK *pECB, int iError, int iErrorType, char *szMsg, int iTermId);
void GetKeyValue(char **pQueryString, char *pKey, char *pValue, int iMax, WEBERROR err);
int GetIntKeyValue(char **pQueryString, char *pKey, WEBERROR NoKeyErr, WEBERROR NotIntErr);
void TermInit(void);
void TermDeleteAll(void);
int TermAdd(void);
void TermDelete(int id);
void ErrorForm(EXTENSION_CONTROL_BLOCK *pECB, int iType, int iErrorNum, int iTermId, int iSyncId, char *szErrorText, char *szBuffer );
void MakeMainMenuForm(int iTermId, int iSyncID, char *szForm);
```

Appendix A - Application Source Code

```
void MakeStockLevelForm(int iTermId, STOCK_LEVEL_DATA *pStockLevelData, BOOL bInput, char *szForm);
void MakeNewOrderForm(int iTermId, NEW_ORDER_DATA *pNewOrderData, BOOL bInput, char *szForm);
void MakePaymentForm(int iTermId, PAYMENT_DATA *pPaymentData, BOOL bInput, char *szForm);
void MakeOrderStatusForm(int iTermId, ORDER_STATUS_DATA *pOrderStatusData, BOOL bInput, char *szForm);
void MakeDeliveryForm(int iTermId, DELIVERY_DATA *pDeliveryData, BOOL bInput, char *szForm);
void ProcessNewOrderForm(EXTENSION_CONTROL_BLOCK *pECB, int iTermId, char *szBuffer);
void ProcessPaymentForm(EXTENSION_CONTROL_BLOCK *pECB, int iTermId, char *szBuffer);
void ProcessOrderStatusForm(EXTENSION_CONTROL_BLOCK *pECB, int iTermId, char *szBuffer);
void ProcessDeliveryForm(EXTENSION_CONTROL_BLOCK *pECB, int iTermId, char *szBuffer);
void ProcessStockLevelForm(EXTENSION_CONTROL_BLOCK *pECB, int iTermId, char *szBuffer);
void GetNewOrderData(LPSTR lpszQueryString, NEW_ORDER_DATA *pNewOrderData);
void GetPaymentData(LPSTR lpszQueryString, PAYMENT_DATA *pPaymentData);
void GetOrderStatusData(LPSTR lpszQueryString, ORDER_STATUS_DATA *pOrderStatusData);
BOOL PostDeliveryInfo(short w_id, short o_carrier_id);
BOOL IsNumeric(char *ptr);
BOOL IsDecimal(char *ptr);
void DeliveryWorkerThread(void *ptr);
```

isapi_dll/src/tpcc.rc

```
//Microsoft Developer Studio generated resource script.
//
#include "resource.h"

#define APSTUDIO_READONLY_SYMBOLS
//
// Generated from the TEXTINCLUDE 2 resource.
//
#include "afxres.h"

//
// English (U.S.) resources
//

#if !defined(AFX_RESOURCE_DLL) || defined(AFX_TARG_ENU)
#ifdef _WIN32
LANGUAGE LANG_ENGLISH, SUBLANG_ENGLISH_US
#pragma code_page(1252)
#endif // _WIN32

#ifdef _MAC
//
// Version
//

VS_VERSION_INFO VERSIONINFO
FILEVERSION 0,4,0,0
PRODUCTVERSION 0,4,0,0
FILEFLAGSMASK 0x3fL
#ifdef _DEBUG
FILEFLAGS 0x1L
```

```
#else
FILEFLAGS 0x0L
#endif
FILEOS 0x40004L
FILETYPE 0x2L
FILESUBTYPE 0x0L
BEGIN
BLOCK "StringFileInfo"
BEGIN
BLOCK "040904b0"
BEGIN
VALUE "Comments", "TPC-C HTML DLL Server (DBLIB)\0"
VALUE "CompanyName", "Microsoft\0"
VALUE "FileDescription", "TPC-C HTML DLL Server (DBLIB)\0"
VALUE "FileVersion", "0, 4, 0, 0\0"
VALUE "InternalName", "tpcc\0"
VALUE "LegalCopyright", "Copyright © 1997\0"
VALUE "OriginalFilename", "tpcc.dll\0"
VALUE "ProductName", "Microsoft tpcc\0"
VALUE "ProductVersion", "0, 4, 0, 0\0"
END
END
BLOCK "VarFileInfo"
BEGIN
VALUE "Translation", 0x409, 1200
END
END

#endif // !_MAC

#ifdef APSTUDIO_INVOKED
//
// TEXTINCLUDE
//

1 TEXTINCLUDE DISCARDABLE
BEGIN
"resource.h\0"
END

2 TEXTINCLUDE DISCARDABLE
BEGIN
#include "afxres.h"\r\n
"\0"
END

3 TEXTINCLUDE DISCARDABLE
BEGIN
"\r\n"
"\0"
END

#endif // APSTUDIO_INVOKED

//
// Dialog
//

IDD_DIALOG1 DIALOG DISCARDABLE 0, 0, 186, 95
```

Appendix A - Application Source Code

```
STYLE DS_MODALFRAME | WS_POPUP | WS_CAPTION | WS_SYSMENU
CAPTION "Dialog"
FONT 8, "MS Sans Serif"
BEGIN
    DEFPUSHBUTTON   "OK",IDOK,129,7,50,14
    PUSHBUTTON     "Cancel",IDCANCEL,129,24,50,14
END

////////////////////////////////////
//
// DESIGNINFO
//

#ifdef APSTUDIO_INVOKED
GUIDELINES DESIGNINFO DISCARDABLE
BEGIN
    IDD_DIALOG1, DIALOG
    BEGIN
        LEFTMARGIN, 7
        RIGHTMARGIN, 179
        TOPMARGIN, 7
        BOTTOMMARGIN, 88
    END
END
#endif // APSTUDIO_INVOKED

#endif // English (U.S.) resources
////////////////////////////////////

#ifndef APSTUDIO_INVOKED
////////////////////////////////////
//
// Generated from the TEXTINCLUDE 3 resource.
//

////////////////////////////////////
#endif // not APSTUDIO_INVOKED

isapi_dll/src/tpcc.cpp

/*      FILE:          TPCC.C
 *
 *      Microsoft TPC-C Kit Ver. 4.20.000
 *      Copyright Microsoft, 1999
 *
 *      All Rights Reserved
 *
 *      Version 4.10.000 audited by Richard Gimarc,
 *      Performance Metrics, 3/17/99
 *
 *      PURPOSE: Main module for TPCC.DLL which is an ISAPI service dll.
 *      Contact: Charles Levine (clevine@microsoft.com)
 *
 *      Change history:
 *      4.20.000 - reworked error handling; added options for COM and Encina
 *      txn monitors
 */
```

```
*/
#include <windows.h>
#include <process.h>
#include <tchar.h>
#include <stdio.h>
#include <stdarg.h>
#include <malloc.h>
#include <stdlib.h>
#include <string.h>
#include <time.h>
#include <sys\timeb.h>
#include <io.h>
#include <assert.h>

#include <sqltypes.h>

#ifdef ICECAP
#include <icapexp.h>
#endif

#include "..\..\common\src\trans.h" //tpckit transaction header contains
definitions of structures specific to TPC-C
#include "..\..\common\src\error.h"
#include "..\..\common\src\txn_base.h"
#include "..\..\common\src\ReadRegistry.h"

#include "..\..\common\txnlog\include\rtetime.h"
#include "..\..\common\txnlog\include\spinlock.h"
#include "..\..\common\txnlog\include\txnlog.h"

// Database layer includes
#include "..\..\db_dblib_dll\src\tpcc_dblib.h" // DBLIB implementation of
TPC-C txns
#include "..\..\db_odbc_dll\src\tpcc_odbc.h" // ODBC implementation of
TPC-C txns

// Txn monitor layer includes
#include "..\..\tm_com_dll\src\tpcc_com.h" // COM Services
implementation on TPC-C txns
#include "..\..\tm_tuxedo_dll\src\tpcc_tux.h" // interface to Tuxedo
libraries
#include "..\..\tm_encina_dll\src\tpcc_enc.h" // interface to Encina
libraries

#include "httpext.h" //ISAPI DLL information
header
#include "tpcc.h" //this dlls specific
structure, value e.t. header.

#define LEN_ERR_STRING 256

// defines for Make<Txn>Form calls to distinguish input and output flavors
#define OUTPUT_FORM 0
#define INPUT_FORM 1

char szMyComputerName[MAX_COMPUTERNAME_LENGTH+1];

//Terminal client id structure
TERM Term = { 0, 0, 0, NULL };

// The WEBCLIENT_VERSION string specifies the version level of this web client interface.
```

Appendix A - Application Source Code

```
// The RTE must be synchronized with the interface level on login, otherwise the login
// will fail. This is a sanity check to catch problems resulting from mismatched
versions
// of the RTE and web client.
#define WEBCCLIENT_VERSION "410"

static CRITICAL_SECTION TermCriticalSection;

static HINSTANCE hLibInstanceTm = NULL;
static HINSTANCE hLibInstanceDb = NULL;

TYPE_CTPCC_DBLIB *pCTPCC_DBLIB_new;
TYPE_CTPCC_ODBC *pCTPCC_ODBC_new;
TYPE_CTPCC_TUXEDO *pCTPCC_TUXEDO_new;
TYPE_CTPCC_ENCINA *pCTPCC_ENCINA_new;
TYPE_CTPCC_ENCINA *pCTPCC_ENCINA_post_init;
TYPE_CTPCC_COM *pCTPCC_COM_new;

// For deferred Delivery txns:

CTxnLog //used to log delivery transaction information *txnDelilog = NULL;

HANDLE hWorkerSemaphore =
INVALID_HANDLE_VALUE;
HANDLE hDoneEvent
= INVALID_HANDLE_VALUE;
HANDLE *pDeliHandles = NULL;

// configuration settings from registry
TPCCREGISTRYDATA Reg;

DWORD dwNumDeliveryThreads = 4;
CRITICAL_SECTION DelBuffCriticalSection; //critical section
for delivery transactions cache
DELIVERY_TRANSACTION *pDelBuff = NULL;
DWORD dwDelBuffSize = 100;
// size of circular buffer for delivery txns
DWORD dwDelBuffFreeCount;
// number of buffers free
DWORD dwDelBuffBusyIndex = 0;
// index position of entry waiting to be delivered
DWORD dwDelBuffFreeIndex = 0;
// index position of unused entry

#include "..\..\common\src\ReadRegistry.cpp"

/* FUNCTION: DllMain
*
* PURPOSE: This function is the entry point for the DLL. This implementation is
based on the fact that DLL_PROCESS_ATTACH is only called from the inet
service once.
*
* ARGUMENTS: HANDLE hModule module handle
* DWORD ul_reason_for_call reason for call
* LPVOID lpReserved reserved for future use
*
* RETURNS: BOOL FALSE errors
occured in initialization
```

```
* TRUE
*/
DLL successfully initialized

BOOL APIENTRY DllMain(HANDLE hModule, DWORD ul_reason_for_call, LPVOID lpReserved)
{
    DWORD i;
    char szEvent[LEN_ERR_STRING] = "\0";
    char szLogFile[128];
    char szDllName[128];

    // debugging...
    // DebugBreak();

    try
    {
        switch( ul_reason_for_call )
        {
            case DLL_PROCESS_ATTACH:
            {
                DWORD dwSize =
                MAX_COMPUTERNAME_LENGTH+1;
                GetComputerName(szMyComputerName,
                &dwSize);
                szMyComputerName[dwSize] = 0;

                DisableThreadLibraryCalls((HMODULE)hModule);
                InitializeCriticalSection(&TermCriticalSection);

                if ( ReadTPCCRegistrySettings( &Reg ) )
                    throw new CWEBCLNT_ERR(
                    ERR_MISSING_REGISTRY_ENTRIES );

                dwDelBuffSize = min( Reg.dwMaxPendingDeliveries,
                10000 ); // min with 10000 as a sanity constraint
                dwNumDeliveryThreads = min(
                Reg.dwNumberOfDeliveryThreads, 100 ); // min with 100 as a sanity constraint

                TermInit();

                // load DLL for txn monitor
                if (Reg.eTxnMon == TUXEDO)
                {
                    strcpy( szDllName, Reg.szPath );
                    strcat( szDllName, "tpcc_tuxedo.dll");
                    hLibInstanceTm = LoadLibrary( szDllName );

                    if (hLibInstanceTm == NULL)
                        throw new CWEBCLNT_ERR(
                        ERR_LOADDLL_FAILED, szDllName, GetLastError() );

                    // get function pointer to wrapper for
                    pCTPCC_TUXEDO_new =
                    (TYPE_CTPCC_TUXEDO*) GetProcAddress(hLibInstanceTm, "CTPCC_TUXEDO_new");
                    if (pCTPCC_TUXEDO_new == NULL)
                        throw new CWEBCLNT_ERR(
                        ERR_GETPROCADDR_FAILED, szDllName, GetLastError() );
                }
                else if (Reg.eTxnMon == ENCINA)
                {
                    strcpy( szDllName, Reg.szPath );
                }
            }
        }
    }
}
```

Appendix A - Application Source Code

```

        strcat( szDllName, "tpcc_encina.dll");
        hLibInstanceTm = LoadLibrary( szDllName
);
        if (hLibInstanceTm == NULL)
            throw new CWEBCLNT_ERR(
ERR_LOADDLL_FAILED, szDllName, GetLastError() );
        // get function pointer to wrapper for
class constructor
        pCTPCC_ENCINA_new =
(TYPE_CTPCC_ENCINA*) GetProcAddress(hLibInstanceTm, "CTPCC_ENCINA_new");
        pCTPCC_ENCINA_post_init =
(TYPE_CTPCC_ENCINA*) GetProcAddress(hLibInstanceTm, "CTPCC_ENCINA_post_init");
        if (pCTPCC_ENCINA_new == NULL)
            throw new CWEBCLNT_ERR(
ERR_GETPROCADDR_FAILED, szDllName, GetLastError() );
        }
        else if (Reg.eTxnMon == COM)
        {
            strcpy( szDllName, Reg.szPath );
            strcat( szDllName, "tpcc_com.dll");
            hLibInstanceTm = LoadLibrary( szDllName
);
            if (hLibInstanceTm == NULL)
                throw new CWEBCLNT_ERR(
ERR_LOADDLL_FAILED, szDllName, GetLastError() );
            // get function pointer to wrapper for
class constructor
            pCTPCC_COM_new = (TYPE_CTPCC_COM*)
GetProcAddress(hLibInstanceTm, "CTPCC_COM_new");
            if (pCTPCC_COM_new == NULL)
                throw new CWEBCLNT_ERR(
ERR_GETPROCADDR_FAILED, szDllName, GetLastError() );
        }
        // load DLL for database connection
        if ((Reg.eTxnMon == None) ||
(dwNumDeliveryThreads > 0))
        {
            if (Reg.eDB_Protocol == DBLIB)
            {
                strcpy( szDllName, Reg.szPath
);
                strcat( szDllName,
"tpcc_dblib.dll");
                szDllName );
                hLibInstanceDb = LoadLibrary(
                if (hLibInstanceDb == NULL)
                    throw new
                CWEBCLNT_ERR( ERR_LOADDLL_FAILED, szDllName, GetLastError() );
                // get function pointer to
wrapper for class constructor
                pCTPCC_DBLIB_new =
(TYPE_CTPCC_DBLIB*) GetProcAddress(hLibInstanceDb, "CTPCC_DBLIB_new");
                if (pCTPCC_DBLIB_new == NULL)
                    throw new
                CWEBCLNT_ERR( ERR_GETPROCADDR_FAILED, szDllName, GetLastError() );
            }
            else if (Reg.eDB_Protocol == ODBC)
            {
                strcpy( szDllName, Reg.szPath
);
                strcat( szDllName, "tpcc_odbc.dll");
                szDllName );
                hLibInstanceDb = LoadLibrary(
                if (hLibInstanceDb == NULL)
                    throw new
                CWEBCLNT_ERR( ERR_LOADDLL_FAILED, szDllName, GetLastError() );
                // get function pointer to
wrapper for class constructor
                pCTPCC_ODBC_new =
(TYPE_CTPCC_ODBC*) GetProcAddress(hLibInstanceDb, "CTPCC_ODBC_new");
                if (pCTPCC_ODBC_new == NULL)
                    throw new
                CWEBCLNT_ERR( ERR_GETPROCADDR_FAILED, szDllName, GetLastError() );
            }
        }
        if (dwNumDeliveryThreads)
        {
            // for deferred delivery txns:
            hDoneEvent = CreateEvent( NULL, TRUE /*
manual reset */, FALSE /* initially not signalled */, NULL );
            InitializeCriticalSection(&DelBuffCriticalSection);
            hWorkerSemaphore = CreateSemaphore(
            NULL, 0, dwDelBuffSize, NULL );
            dwDelBuffFreeCount = dwDelBuffSize;
            InitJulianTime(NULL);
            // create unique log file name based on
            SYSTEMTIME Time;
            GetLocalTime( &Time );
            wsprintf( szLogFile, "%sdelivery-
%2.2d%2.2d%2.2d-%2.2d%2.2d.log",
                Reg.szPath,
                Time.wYear % 100, Time.wMonth, Time.wDay, Time.wHour, Time.wMinute );
            txnDelilog = new CTxnLog(szLogFile,
            TXN_LOG_WRITE);
            //write event into txn log for START
            txnDelilog->WriteCtrlRecToLog(TXN_EVENT_START, szMyComputerName, sizeof(szMyComputerName));
            // allocate structures for delivery
            buffers and thread mgmt
            pDeliHandles = new
            HANDLE[dwNumDeliveryThreads];
            pDelBuff = new
            DELIVERY_TRANSACTION[dwDelBuffSize];
            // launch DeliveryWorkerThread to
            perform actual delivery txns
            for(i=0; i<dwNumDeliveryThreads; i++)
            {
                pDeliHandles[i] = (HANDLE)
                _beginthread( DeliveryWorkerThread, 0, NULL );
                if (pDeliHandles[i] ==
                INVALID_HANDLE_VALUE)
                    throw new
                CWEBCLNT_ERR( ERR_DELIVERY_THREAD_FAILED );
            }
        }
    }
};
```

```

        strcat( szDllName,
"tpcc_odbc.dll");
        szDllName );
        hLibInstanceDb = LoadLibrary(
        if (hLibInstanceDb == NULL)
            throw new
            CWEBCLNT_ERR( ERR_LOADDLL_FAILED, szDllName, GetLastError() );
            // get function pointer to
wrapper for class constructor
            pCTPCC_ODBC_new =
(TYPE_CTPCC_ODBC*) GetProcAddress(hLibInstanceDb, "CTPCC_ODBC_new");
            if (pCTPCC_ODBC_new == NULL)
                throw new
            CWEBCLNT_ERR( ERR_GETPROCADDR_FAILED, szDllName, GetLastError() );
        }
    }
    if (dwNumDeliveryThreads)
    {
        // for deferred delivery txns:
        hDoneEvent = CreateEvent( NULL, TRUE /*
manual reset */, FALSE /* initially not signalled */, NULL );
        InitializeCriticalSection(&DelBuffCriticalSection);
        hWorkerSemaphore = CreateSemaphore(
        NULL, 0, dwDelBuffSize, NULL );
        dwDelBuffFreeCount = dwDelBuffSize;
        InitJulianTime(NULL);
        // create unique log file name based on
        SYSTEMTIME Time;
        GetLocalTime( &Time );
        wsprintf( szLogFile, "%sdelivery-
%2.2d%2.2d%2.2d-%2.2d%2.2d.log",
            Reg.szPath,
            Time.wYear % 100, Time.wMonth, Time.wDay, Time.wHour, Time.wMinute );
        txnDelilog = new CTxnLog(szLogFile,
        TXN_LOG_WRITE);
        //write event into txn log for START
        txnDelilog->WriteCtrlRecToLog(TXN_EVENT_START, szMyComputerName, sizeof(szMyComputerName));
        // allocate structures for delivery
        buffers and thread mgmt
        pDeliHandles = new
        HANDLE[dwNumDeliveryThreads];
        pDelBuff = new
        DELIVERY_TRANSACTION[dwDelBuffSize];
        // launch DeliveryWorkerThread to
        perform actual delivery txns
        for(i=0; i<dwNumDeliveryThreads; i++)
        {
            pDeliHandles[i] = (HANDLE)
            _beginthread( DeliveryWorkerThread, 0, NULL );
            if (pDeliHandles[i] ==
            INVALID_HANDLE_VALUE)
                throw new
            CWEBCLNT_ERR( ERR_DELIVERY_THREAD_FAILED );
        }
    }
};
```

Appendix A - Application Source Code

```
    }
    break;
case DLL_PROCESS_DETACH:
    if (dwNumDeliveryThreads)
    {
        if (txnDelilog != NULL)
        {
            //write event into txn log
            txnDelilog->
>WriteCtrlRecToLog(TXN_EVENT_STOP, szMyComputerName, sizeof(szMyComputerName));

            // This will do a clean
            // shutdown of the delivery log file
            CTxnLog *txnDelilogLocal =
            txnDelilog;
            delete txnDelilogLocal;

            delete [] pDeliHandles;
            delete [] pDelBuff;

            CloseHandle( hWorkerSemaphore );
            CloseHandle( hDoneEvent );

            DeleteCriticalSection(&DelBuffCriticalSection);
        }

        DeleteCriticalSection(&TermCriticalSection);

        if (hLibInstanceTm != NULL)
            FreeLibrary( hLibInstanceTm );
        hLibInstanceTm = NULL;

        if (hLibInstanceDb != NULL)
            FreeLibrary( hLibInstanceDb );
        hLibInstanceDb = NULL;

        Sleep(500);
        break;
    }
default:
    /* nothing */;
}
}
catch (CBaseErr *e)
{
    WriteMessageToEventLog( e->ErrorText() );
    delete e;
    TerminateExtension(0);
    return FALSE;
}
catch (...)
{
    WriteMessageToEventLog(TEXT("Unhandled exception. DLL could not
load.));
    TerminateExtension(0);
    return FALSE;
}
}
```

```
    return TRUE;
}

/* FUNCTION: GetExtensionVersion
* PURPOSE: This function is called by the inet service when the DLL is first
loaded.
* ARGUMENTS: HSE_VERSION_INFO *pVer passed in structure in which to place
expected version number.
* RETURNS: TRUE inet service expected return value.
*/
BOOL WINAPI GetExtensionVersion(HSE_VERSION_INFO *pVer)
{
    pVer->dwExtensionVersion = MAKELONG(HSE_VERSION_MINOR, HSE_VERSION_MAJOR);
    lstrcpy(pVer->lpszExtensionDesc, "TPC-C Server.", HSE_MAX_EXT_DLL_NAME_LEN);

    // TODO: why do we need this here instead of in the DLL attach?
    if (Reg.eTxnMon == ENCINA)
        pCTPCC_ENCINA_post_init();

    return TRUE;
}

/* FUNCTION: TerminateExtension
* PURPOSE: This function is called by the inet service when the DLL is about to
be unloaded.
* ARGUMENTS: Release all resources in anticipation of being unloaded.
* RETURNS: TRUE inet service expected return value.
*/
BOOL WINAPI TerminateExtension( DWORD dwFlags )
{
    if (pDeliHandles)
    {
        SetEvent( hDoneEvent );
        for(DWORD i=0; i<dwNumDeliveryThreads; i++)
            WaitForSingleObject( pDeliHandles[i], INFINITE );
    }

    TermDeleteAll();
    return TRUE;
}

/* FUNCTION: HttpExtensionProc
* PURPOSE: This function is the main entry point for the TPCC DLL. The internet
service
calls this function passing in the http string.
* ARGUMENTS: EXTENSION_CONTROL_BLOCK *pECB structure pointer to passed
in internet
service information.
* RETURNS: DWORD HSE_STATUS_SUCCESS
connection can be dropped if error
```

Appendix A - Application Source Code

```
*
*      HSE_STATUS_SUCCESS_AND_KEEP_CONN      keep connect valid comment sent
*
* COMMENTS:      None
*
*/
DWORD WINAPI HttpExtensionProc(EXTENSION_CONTROL_BLOCK *pECB)
{
    int          iCmd, FormId, TermId, iSyncId;
    char         szBuffer[4096];

    int          lpbSize;
    static char  szHeader[] = "200 Ok";
    DWORD        dwSize = 6;          // initial value is
    strlen(szHeader)
    char         szHeader1[4096];

#ifdef ICECAP
    StartCAP();
#endif

    try
    {
        //process http query
        ProcessQueryString(pECB, &iCmd, &FormId, &TermId, &iSyncId);

        if (TermId != 0)
        {
            if ( TermId < 0 || TermId >= Term.iNumEntries ||
                Term.pClientData[TermId].iNextFree != -1 )
            {
                // debugging...
                char szTmp[128];
                wsprintf( szTmp, "Invalid term ID; TermId = %d",
                    TermId );

                WriteMessageToEventLog( szTmp );

                throw new CWEBCLNT_ERR( ERR_INVALID_TERMID );
            }

            //must have a valid syncid here since termid is valid
            if (iSyncId != Term.pClientData[TermId].iSyncId)
                throw new CWEBCLNT_ERR(
                    ERR_INVALID_SYNC_CONNECTION );

            //set use time
            Term.pClientData[TermId].iTickCount = GetTickCount();
        }

        switch(iCmd)
        {
        case 0:
            WelcomeForm(pECB, szBuffer);
            break;

        case 1:
            switch( FormId )
            {
                case WELCOME_FORM:
                case MAIN_MENU_FORM:
                    break;

                case NEW_ORDER_FORM:
                    ProcessNewOrderForm(pECB, TermId,
                        szBuffer);
                    break;

                case PAYMENT_FORM:
                    ProcessPaymentForm(pECB, TermId,
                        szBuffer);
                    break;

                case DELIVERY_FORM:
                    ProcessDeliveryForm(pECB, TermId,
                        szBuffer);
                    break;

                case ORDER_STATUS_FORM:
                    ProcessOrderStatusForm(pECB, TermId,
                        szBuffer);
                    break;

                case STOCK_LEVEL_FORM:
                    ProcessStockLevelForm(pECB, TermId,
                        szBuffer);
                    break;
            }
            break;

        case 2:
            // new-order selected from menu; display new-order input
            form
            MakeNewOrderForm(TermId, NULL, INPUT_FORM, szBuffer);
            break;

        case 3:
            // payment selected from menu; display payment input form
            MakePaymentForm(TermId, NULL, INPUT_FORM, szBuffer);
            break;

        case 4:
            // delivery selected from menu; display delivery input form
            MakeDeliveryForm(TermId, NULL, INPUT_FORM, szBuffer);
            break;

        case 5:
            // order-status selected from menu; display order-status
            input form
            MakeOrderStatusForm(TermId, NULL, INPUT_FORM, szBuffer);
            break;

        case 6:
            // stock-level selected from menu; display stock-level
            input form
            MakeStockLevelForm(TermId, NULL, INPUT_FORM, szBuffer);
            break;

        case 7:
            // ExitCmd
            TermDelete(TermId);
            WelcomeForm(pECB, szBuffer);
            break;

        case 8:
            SubmitCmd(pECB, szBuffer);
            break;

        case 9:
            // menu
            MakeMainMenuForm(TermId, Term.pClientData[TermId].iSyncId,
                szBuffer);
            break;

        case 10:
            // CMD=Clear
            // resets all connections; should only be used when no
            other connections are active
            TermDeleteAll();
        }
    }
}
```

Appendix A - Application Source Code

```
        TermInit();
        WelcomeForm(pECB, szBuffer);
        break;
    case 11: // CMD=Stats
        StatsCmd(pECB, szBuffer);
        break;
    }
}
catch (CBaseErr *e)
{
    ErrorForm( pECB, e->ErrorType(), e->ErrorNum(), TermId, iSyncId, e-
>ErrorText(), szBuffer );
    delete e;
}
catch (...)
{
    ErrorForm( pECB, ERR_TYPE_WEBDLL, 0, TermId, iSyncId, "Error:
Unhandled exception in Web Client.", szBuffer );
}

#ifdef ICECAP
    StopCAP();
#endif

    lpbSize = strlen(szBuffer);
    wsprintf(szHeader1,
        "Content-Type: text/html\r\n"
        "Content-Length: %d\r\n"
        "Connection: Keep-Alive\r\n\r\n" , lpbSize);
    strcat( szHeader1, szBuffer );

    (*pECB->ServerSupportFunction)(pECB->ConnID, HSE_REQ_SEND_RESPONSE_HEADER,
szHeader, (LPDWORD) &dwSize, (LPDWORD)szHeader1);

    //finish up and keep connection
    pECB->dwHttpStatusCode = 200;
    return HSE_STATUS_SUCCESS_AND_KEEP_CONN;
}

void WriteMessageToEventLog(LPTSTR lpszMsg)
{
    TCHAR    szMsg[256];
    HANDLE   hEventSource;
    LPTSTR   lpszStrings[2];

    // Use event logging to log the error.
    //
    hEventSource = RegisterEventSource(NULL, TEXT("TPCC.DLL"));

    _stprintf(szMsg, TEXT("Error in TPCC.DLL: "));
    lpszStrings[0] = szMsg;
    lpszStrings[1] = lpszMsg;

    if (hEventSource != NULL)
    {
        ReportEvent(hEventSource, // handle of event source
            EVENTLOG_ERROR_TYPE, // event type
            0, // event category
            0, // event ID
            NULL, // current user's SID
            2, // strings in lpszStrings

```

```

        0, // no bytes of raw data
        (LPCTSTR *)lpszStrings, // array of error strings
        NULL); // no raw data
    }
}
(VOID) DeregisterEventSource(hEventSource);
}

/* FUNCTION: DeliveryWorkerThread
 *
 * PURPOSE: This function processes deferred delivery txns. There are typically
several threads running this routine. The number of threads is
determined by an entry read from the registry. The thread waits for work by
waiting on semaphore. When a delivery txn is posted, the semaphore is released.
After processing the delivery txn, information is logged to record the txn
status and execution time.
 */

/*static*/ void DeliveryWorkerThread(void *ptr)
{
    CTPCC_BASE *pTxn = NULL;
    DELIVERY_TRANSACTION delivery;
    PDELIVERY_DATA pDeliveryData;
    TXN_RECORD_TPCC_DELIV_DEF txnDeliRec;
    DWORD index;
    HANDLE handles[2];
    SYSTEMTIME trans_end; //delivery
    transaction finished time
    SYSTEMTIME trans_start; //delivery transaction start
    time

    assert(txnDeliRec != NULL);

    try
    {
        if (Reg.eDB_Protocol == ODBC)
            pTxn = pCTPCC_ODBC_new( Reg.szDbServer, Reg.szDbUser,
Reg.szDbPassword, szMyComputerName, Reg.szDbName );
        else if (Reg.eDB_Protocol == DBLIB)
            pTxn = pCTPCC_DBLIB_new( Reg.szDbServer, Reg.szDbUser,
Reg.szDbPassword, szMyComputerName, Reg.szDbName );
        pDeliveryData = pTxn->BuffAddr_Delivery();
    }
    catch (CBaseErr *e)
    {
        char szTmp[1024];
        wsprintf( szTmp, "Error in Delivery Txn thread. Could not connect to
database. "
            "%s. Server=%s, User=%s, Password=%s,
            e->ErrorText(), Reg.szDbServer, Reg.szDbUser,
            Reg.szDbPassword, Reg.szDbName );
        WriteMessageToEventLog( szTmp );
        delete e;
    }
}

```

Appendix A - Application Source Code

```
    }
    else
        // No free buffers. Return an error, which indicates that the
        // delivery buffer is full.
        // Most likely, the number of delivery worker threads needs to be
        // increased to keep up
        // with the txn rate.
        bError = TRUE;
        LeaveCriticalSection(&DelBuffCriticalSection);

        if (!bError)
            // increment worker semaphore to wake up a worker thread
            ReleaseSemaphore( hWorkerSemaphore, 1, NULL );

        return bError;
    }

/* FUNCTION: ProcessQueryString
 *
 * PURPOSE:      This function extracts the relevent information out of the http
 *               command passed in from
 *               the browser.
 *
 * COMMENTS:     If this is the initial connection i.e. client is at welcome screen
 *               then
 *               there will not be a terminal id or current form
 *               id. If this is the case
 *               then the pTermid and pFormid return values are
 *               undefined.
 */

void ProcessQueryString(EXTENSION_CONTROL_BLOCK *pECB, int *pCmd, int *pFormId, int
*pTermId, int *pSyncId)
{
    char *ptr = pECB->lpszQueryString;
    char szBuffer[25];
    int i;

    //allowable client command strings i.e. CMD=command
    static char *szCmds[] =
    {
        "Process", "..NewOrder..", "..Payment..", "..Delivery..", "..Order-
        Status..", "..Stock-Level..",
        "..Exit..", "Submit", "Menu", "Clear", "Stats", ""
    };

    *pCmd = 0; // default is the login screen
    *pTermId = 0;

    // if no params (i.e., empty query string), then return login screen
    if (strlen(pECB->lpszQueryString) == 0)
        return;

    // parse FORMID, TERMID, and SYNCID
    *pFormId = GetIntKeyValue(&ptr, "FORMID", NO_ERR, NO_ERR);
    *pTermId = GetIntKeyValue(&ptr, "TERMID", NO_ERR, NO_ERR);
    *pSyncId = GetIntKeyValue(&ptr, "SYNCID", NO_ERR, NO_ERR);

    // parse CMD
    GetKeyValue(&ptr, "CMD", szBuffer, sizeof(szBuffer), ERR_COMMAND_UNDEFINED);

    // see which command it matches
    for(i=0; i++)
```

```
    {
        if (szCmds[i][0] == 0)
            // no more; no match; return error
            throw new CWEBCLNT_ERR( ERR_COMMAND_UNDEFINED );
        if ( !strcmp(szCmds[i], szBuffer) )
            {
                *pCmd = i+1;
                break;
            }
    }

/* FUNCTION: void WelcomeForm
 *
 */

void WelcomeForm(EXTENSION_CONTROL_BLOCK *pECB, char *szBuffer)
{
    char szTmp[1024];

    //welcome to tpc-c html form buffer, this is first form client sees.
    strcpy( szBuffer, "<HTML><HEAD><TITLE>TPC-C Web Client</TITLE></HEAD><BODY>"
        "<B><BIG>Microsoft TPC-C Web
        Client (ver 4.20)</BIG></B> <BR> <BR>"
        "New\ "<PRE>"
        "Compiled: "__DATE__",
        "__TIME__" <BR>"
        "Source:  "__FILE__"
        ("__TIMESTAMP__") <BR>"
        "</PRE></font>"
        "<FORM ACTION=\"tpcc.dll\"
        METHOD=\"GET\">"
        "NAME=\"STATUSID\" VALUE=\"0\">"
        "NAME=\"ERROR\" VALUE=\"0\">"
        "NAME=\"FORMID\" VALUE=\"1\">"
        "NAME=\"TERMID\" VALUE=\"0\">"
        "NAME=\"SYNCID\" VALUE=\"0\">"
        "NAME=\"VERSION\" VALUE=\" " WEBCLIENT_VERSION "\">"
        );

    sprintf( szTmp, "Configuration Settings: <BR><font face=\"Courier New\"
    color=\"blue\"><PRE>"
        "Txn Monitor =
        <B>%s</B><BR>" "Database protocol =
        <B>%s</B><BR>" "Max Connections =
        <B>%d</B><BR>" "# of Delivery Threads =
        <B>%d</B><BR>" "Max Pending Deliveries =
        , szTxnMonNames[Reg.eTxnMon], szDBNames[Reg.eDB_Protocol],
        Reg.dwMaxConnections, dwNumDeliveryThreads, dwDelBuffSize
    );
    strcat( szBuffer, szTmp);
```

Appendix A - Application Source Code

```
if (Reg.eTxnMon == COM)
{
    sprintf( szTmp, "COM Single Pool = <B>%s</B><BR>",
            Reg.bCOM_SinglePool ? "YES" : "NO" );
    strcat( szBuffer, szTmp);
}
strcat( szBuffer, "</PRE></font>");

if (Reg.eTxnMon == None)
    // connection options may be specified when not using a txn monitor
    sprintf( szTmp, "Please enter your database options for this
connection:<BR>"

color="blue"><PRE>"
                                "<font face=\"Courier New\"
                                "DB Server = <INPUT
NAME=\"db_server\" SIZE=20 VALUE=\"%s\"><BR>"
                                "DB User ID = <INPUT
NAME=\"db_user\" SIZE=20 VALUE=\"%s\"><BR>"
                                "DB Password = <INPUT
NAME=\"db_passwd\" SIZE=20 VALUE=\"%s\"><BR>"
                                "DB Name = <INPUT
NAME=\"db_name\" SIZE=20 VALUE=\"%s\"><BR>"
                                "</PRE></font>"
                                , Reg.szDbServer, Reg.szDbUser,
                                Reg.szDbPassword, Reg.szDbName );
    else
        // if using a txn monitor, connection options are determined from
        registry; can't
        // set per user. show options fyi
        sprintf( szTmp, "Database options which will be used by the
transaction monitor:<BR>"

color="blue"><PRE>"
                                "<font face=\"Courier New\"
                                "DB Server =
                                "DB User ID =
                                "DB Password =
                                "DB Name =
                                "</PRE></font>"
                                , Reg.szDbServer, Reg.szDbUser,
                                Reg.szDbPassword, Reg.szDbName );
    strcat( szBuffer, szTmp);

    sprintf( szTmp, "Please enter your Warehouse and District for this
session:<BR>"

color="blue"><PRE>" );
    strcat( szBuffer, szTmp);
    strcat( szBuffer, "Warehouse ID = <INPUT NAME=\"w_id\" SIZE=4><BR>"
            "District ID = <INPUT
NAME=\"d_id\" SIZE=2><BR>"

                                "</PRE></font><HR>"
                                "<INPUT TYPE=\"submit\"
NAME=\"CMD\" VALUE=\"Submit\">"
                                "</FORM></BODY></HTML>");
}

/* FUNCTION: SubmitCmd
*
```

```
* PURPOSE: This function allocated a new terminal id in the Term structure
array.
*/

void SubmitCmd(EXTENSION_CONTROL_BLOCK *pECB, char *szBuffer)
{
    int iNewTerm;
    char *ptr = pECB->lpszQueryString;

    char szVersion[32] = { 0 };
    char szServer[32] = { 0 };
    char szUser[32] = "sa";
    char szPassword[32] = { 0 };
    char szDatabase[32] = "tpcc";

    // validate version field; the version field ensures that the RTE is
    synchronized with the web client
    GetKeyValue(&ptr, "VERSION", szVersion, sizeof(szVersion),
ERR_VERSION_MISMATCH);
    if ( strcmp( szVersion, WEBCLIENT_VERSION ) )
        throw new CWEBCLNT_ERR( ERR_VERSION_MISMATCH );

    if (Reg.eTxnMon == None)
    {
        // parse Server name
        GetKeyValue(&ptr, "db_server", szServer, sizeof(szServer),
ERR_NO_SERVER_SPECIFIED);
        // parse User name
        GetKeyValue(&ptr, "db_user", szUser, sizeof(szUser), NO_ERR);
        // parse Password
        GetKeyValue(&ptr, "db_passwd", szPassword, sizeof(szPassword),
NO_ERR);
        // parse Database name
        GetKeyValue(&ptr, "db_name", szDatabase, sizeof(szDatabase), NO_ERR);
    }

    // parse warehouse ID
    int w_id = GetIntKeyValue(&ptr, "w_id", ERR_HTML_ILL_FORMED, ERR_W_ID_INVALID);
    if ( w_id < 1 )
        throw new CWEBCLNT_ERR( ERR_W_ID_INVALID );

    // parse district ID
    int d_id = GetIntKeyValue(&ptr, "d_id", ERR_HTML_ILL_FORMED, ERR_D_ID_INVALID);
    if ( d_id < 1 || d_id > 10 )
        throw new CWEBCLNT_ERR( ERR_D_ID_INVALID );

    iNewTerm = TermAdd();
    Term.pClientData[iNewTerm].w_id = w_id;
    Term.pClientData[iNewTerm].d_id = d_id;

    try
    {
        if (Reg.eTxnMon == TUXEDO)
            Term.pClientData[iNewTerm].pTxn = pCTPCC_TUXEDO_new();
        else if (Reg.eTxnMon == ENCINA)
            Term.pClientData[iNewTerm].pTxn = pCTPCC_ENCINA_new();
        else if (Reg.eTxnMon == COM)
            Term.pClientData[iNewTerm].pTxn = pCTPCC_COM_new(
Reg.bCOM_SinglePool );
        else if (Reg.eDB_Protocol == ODBC)

```

Appendix A - Application Source Code

```

        Term.pClientData[iNewTerm].pTxn = pCTPCC_ODBC_new(
szServer, szUser, szPassword, szMyComputerName, szDatabase );
        else if (Reg.eDB_Protocol == DBLIB)
            Term.pClientData[iNewTerm].pTxn = pCTPCC_DBLIB_new(
szServer, szUser, szPassword, szMyComputerName, szDatabase );
    }
    catch (...)
    {
        TermDelete(iNewTerm);
        throw; // pass exception upward
    }

    MakeMainMenuForm(iNewTerm, Term.pClientData[iNewTerm].iSyncId, szBuffer);
}

/* FUNCTION: StatsCmd
 *
 * PURPOSE: This function returns to the browser the total number of active
terminal ids.
 *
 * This routine is for development/debugging purposes.
 *
 */

void StatsCmd(EXTENSION_CONTROL_BLOCK *pECB, char *szBuffer)
{
    int i;
    int iTotals;

    EnterCriticalSection(&TermCriticalSection);

    iTotals = 0;
    for(i=0; i<Term.iNumEntries; i++)
    {
        if (Term.pClientData[i].iNextFree == -1)
            iTotals++;
    }

    LeaveCriticalSection(&TermCriticalSection);

    wsprintf( szBuffer,
        "<HTML><HEAD><TITLE>TPC-C Web Client Stats</TITLE></HEAD>"
        "<BODY><B><BIG> Total Active Connections: %d"
        , iTotals );
}

char *CWEBCLNT_ERR::ErrorText()
{
    static SERRORMSG errorMsgs[] =
    {
        { ERR_COMMAND_UNDEFINED,
        "Command undefined." },
        { ERR_D_ID_INVALID,
        "Invalid District ID Must be 1 to 10." },
        { ERR_DELIVERY_CARRIER_ID_RANGE,
        "Delivery Carrier ID out of range must be 1 - 10." },
        { ERR_DELIVERY_CARRIER_INVALID,
        "Delivery Carrier ID invalid must be numeric 1 - 10." }
    }
}

```

```

    { ERR_DELIVERY_MISSING_OCD_KEY,
    "Delivery missing Carrier ID key \"OCD*\"." },
    { ERR_DELIVERY_THREAD_FAILED,
    "Could not start delivery worker thread." },
    { ERR_GETPROCADDR_FAILED,
    "Could not map proc in DLL. GetProcAddress error. DLL=" },
    { ERR_HTML_ILL_FORMED,
    "Required key field is missing from HTML string." },
    { ERR_INVALID_SYNC_CONNECTION,
    "Invalid Terminal Sync ID." },
    { ERR_INVALID_TERMID,
    "Invalid Terminal ID." },
    { ERR_LOADDLL_FAILED,
    "Load of DLL failed. DLL=" },
    { ERR_MAX_CONNECTIONS_EXCEEDED,
    "No connections available. Max Connections is probably too low." },
    { ERR_MISSING_REGISTRY_ENTRIES,
    "Required registry entries are missing. Rerun INSTALL to correct." },
    { ERR_NEWORDER_CUSTOMER_INVALID,
    "New Order customer id invalid data type, range = 1 to 3000." },
    { ERR_NEWORDER_CUSTOMER_KEY,
    "New Order missing Customer key \"CID*\"." },
    { ERR_NEWORDER_DISTRICT_INVALID,
    "New Order District ID Invalid range 1 - 10." },
    { ERR_NEWORDER_FORM_MISSING_DID,
    "New Order missing District key \"DID*\"." },
    { ERR_NEWORDER_ITEMID_INVALID,
    "New Order Item Id is wrong data type, must be numeric." },
    { ERR_NEWORDER_ITEMID_RANGE,
    "New Order Item Id is out of range. Range = 1 to 999999." },
    { ERR_NEWORDER_ITEMID_WITHOUT_SUPPW,
    "New Order Item_Id field entered without a corresponding Supp_W." },
    { ERR_NEWORDER_MISSING_IID_KEY,
    "New Order missing Item Id key \"IID*\"." },
    { ERR_NEWORDER_MISSING_QTY_KEY,
    "New Order Missing Qty key \"Qty##*\"." },
    { ERR_NEWORDER_MISSING_SUPPW_KEY,
    "New Order missing Supp_W key \"SP##*\"." },
    { ERR_NEWORDER_NOITEMS_ENTERED,
    "New Order No order lines entered." },
    { ERR_NEWORDER_QTY_INVALID,
    "New Order Qty invalid must be numeric range 1 - 99." },
    { ERR_NEWORDER_QTY_RANGE,
    "New Order Qty is out of range. Range = 1 to 99." }
}

```

Appendix A - Application Source Code

```

        {
            ERR_NEWORDER_QTY_WITHOUT_SUPPW,
            "New Order Qty field entered without a corresponding Supp_W."
        },
        {
            ERR_NEWORDER_SUPPW_INVALID,
            "New Order Supp_W invalid data type must be numeric."
        },
        {
            ERR_NO_SERVER_SPECIFIED,
            "No Server name specified."
        },
        {
            ERR_ORDERSTATUS_CID_AND_CLT,
            "Order Status Only Customer ID or Last Name may be entered, not both."
        },
        {
            ERR_ORDERSTATUS_CID_INVALID,
            "Order Status Customer ID invalid, range must be numeric 1 - 3000."
        },
        {
            ERR_ORDERSTATUS_CLT_RANGE,
            "Order Status Customer last name longer than 16 characters."
        },
        {
            ERR_ORDERSTATUS_DID_INVALID,
            "Order Status District invalid, value must be numeric 1 - 10."
        },
        {
            ERR_ORDERSTATUS_MISSING_CID_CLT,
            "Order Status Either Customer ID or Last Name must be entered."
        },
        {
            ERR_ORDERSTATUS_MISSING_CID_KEY,
            "Order Status missing Customer key \"CID*\"."
        },
        {
            ERR_ORDERSTATUS_MISSING_CLT_KEY,
            "Order Status missing Customer Last Name key \"CLT*\"."
        },
        {
            ERR_ORDERSTATUS_MISSING_DID_KEY,
            "Order Status missing District key \"DID*\"."
        },
        {
            ERR_PAYMENT_CDI_INVALID,
            "Payment Customer district invalid must be numeric."
        },
        {
            ERR_PAYMENT_CID_AND_CLT,
            "Payment Only Customer ID or Last Name may be entered, not both."
        },
        {
            ERR_PAYMENT_CUSTOMER_INVALID,
            "Payment Customer data type invalid, must be numeric."
        },
        {
            ERR_PAYMENT_CWI_INVALID,
            "Payment Customer Warehouse invalid, must be numeric."
        },
        {
            ERR_PAYMENT_DISTRICT_INVALID,
            "Payment District ID is invalid, must be 1 - 10."
        },
        {
            ERR_PAYMENT_HAM_INVALID,
            "Payment Amount invalid data type must be numeric."
        },
        {
            ERR_PAYMENT_HAM_RANGE,
            "Payment Amount out of range, 0 - 9999.99."
        },
        {
            ERR_PAYMENT_LAST_NAME_TO_LONG,
            "Payment Customer last name longer than 16 characters."
        },
        {
            ERR_PAYMENT_MISSING_CDI_KEY,
            "Payment missing Customer district key \"CDI*\"."
        },
        {
            ERR_PAYMENT_MISSING_CID_CLT,
            "Payment Either Customer ID or Last Name must be entered."
        },
        {
            ERR_PAYMENT_MISSING_CID_KEY,
            "Payment missing Customer Key \"CID*\"."
        },
        {
            ERR_PAYMENT_MISSING_CLT_KEY,
            "Payment missing Customer Last Name key \"CLT*\"."
        },
        {
            ERR_PAYMENT_MISSING_CWI_KEY,
            "Payment missing Customer Warehouse key \"CWI*\"."
        },
        {
            ERR_PAYMENT_MISSING_DID_KEY,
            "Payment missing District Key \"DID*\"."
        },
        {
            ERR_PAYMENT_MISSING_HAM_KEY,
            "Payment missing Amount key \"HAM*\"."
        },
        {
            ERR_STOCKLEVEL_MISSING_THRESHOLD_KEY,
            "Stock Level; missing Threshold key \"TT*\"."
        },
        {
            ERR_STOCKLEVEL_THRESHOLD_INVALID,
            "Stock Level; Threshold value must be in the range = 1 - 99."
        },
        {
            ERR_STOCKLEVEL_THRESHOLD_RANGE,
            "Stock Level Threshold out of range, range must be 1 - 99."
        },
        {
            ERR_VERSION_MISMATCH,
            "Invalid version field. RTE and Web Client are probably out of sync."
        },
        {
            ERR_W_ID_INVALID,
            "Invalid Warehouse ID."
        },
        {
            0,
            ""
        }
    };

    char szTmp[256];
    int i = 0;
    while (TRUE)
    {
        if (errorMsgs[i].szMsg[0] == 0)
        {
            strcpy( szTmp, "Unknown error number." );
            break;
        }
        if (m_Error == errorMsgs[i].iError)
        {
            strcpy( szTmp, errorMsgs[i].szMsg );
            break;
        }
        i++;
    }

    if (m_szTextDetail)
        strcat( szTmp, m_szTextDetail );
    if (m_SystemErr)
        wsprintf( szTmp+strlen(szTmp), " Error=%d", m_SystemErr );

    m_szErrorText = new char[strlen(szTmp)+1];
    strcpy( m_szErrorText, szTmp );
    return m_szErrorText;
}

/* FUNCTION: GetKeyValue
 *
 * PURPOSE: This function parses a http formatted string for specific key values.
 *
 * ARGUMENTS: char *pQueryString http string from client browser

```

Appendix A - Application Source Code

```
*
*   key value to look for      char      *pKey
*   character array into which to place key's value
*   maximum length of key value array.      int      iMax
*   error value to throw      WEBERROR      err
* RETURNS:      nothing.
* ERROR:      if (the pKey value is not found) then
*             if (err == 0)
*                 return (empty string)
*             else
*                 throw CWEBCLNT_ERR(err)
* COMMENTS:      http keys are formatted either KEY=value& or KEY=value\0. This DLL
formats
*               TPC-C input fields in such a manner that the keys
can be extracted in the
*               above manner.
*/

void GetKeyValue(char **pQueryString, char *pKey, char *pValue, int iMax, WEBERROR err)
{
    char *ptr;

    if ( !(ptr=strstr(*pQueryString, pKey)) )
        goto ErrorExit;
    ptr += strlen(pKey);
    if ( *ptr != '=' )
        goto ErrorExit;
    ptr++;

    iMax--; // one position is for terminating null
    while( *ptr && *ptr != '&' && iMax)
    {
        *pValue++ = *ptr++;
        iMax--;
    }
    *pValue = 0; // terminating null
    *pQueryString = ptr;
    return;

ErrorExit:
    if (err != NO_ERR)
        throw new CWEBCLNT_ERR( err );
    *pValue = 0; // return empty result string
}

/* FUNCTION: GetIntKeyValue
*
* PURPOSE:      This function parses a http formatted string for a specific key
value.
*
* ARGUMENTS:      char      *pQueryString      http string from
client browser
*
*               char      *pKey
*
*               WEBERROR      NoKeyErr      error
value to throw if key not found
```

```
*
*   value to throw if value not numeric      WEBERROR      NotIntErr      error
* RETURNS:      integer
* ERROR:      if (the pKey value is not found) then
*             if (NoKeyErr != NO_ERR)
*                 throw CWEBCLNT_ERR(err)
*             else
*                 return 0
*             else if (non-numeric char found) then
*                 if (NotIntErr != NO_ERR) then
*                     throw CWEBCLNT_ERR(err)
*                 else
*                     return 0
* COMMENTS:      http keys are formatted either KEY=value& or KEY=value\0. This DLL
formats
*               TPC-C input fields in such a manner that the keys
can be extracted in the
*               above manner.
*/

int GetIntKeyValue(char **pQueryString, char *pKey, WEBERROR NoKeyErr, WEBERROR
NotIntErr)
{
    char *ptr0;
    char *ptr;

    if ( !(ptr=strstr(*pQueryString, pKey)) )
        goto ErrorNoKey;
    ptr += strlen(pKey);
    if ( *ptr != '=' )
        goto ErrorNoKey;
    ptr++;

    ptr0 = ptr; // remember starting point
    // scan string until a terminator (null or &) or a non-digit
    while( *ptr && *ptr != '&' && isdigit(*ptr) )
        ptr++;

    // make sure we stopped scanning for the right reason
    if ((ptr0 == ptr) || (*ptr && *ptr != '&'))
    {
        if (NotIntErr != NO_ERR)
            throw new CWEBCLNT_ERR( NoKeyErr );
        return 0;
    }

    *pQueryString = ptr;
    return atoi(ptr0);

ErrorNoKey:
    if (NoKeyErr != NO_ERR)
        throw new CWEBCLNT_ERR( NoKeyErr );
    return 0;
}

/* FUNCTION: TermInit
*
* PURPOSE:      This function initializes the client terminal structure; it is called
when the TPCC.DLL
*
*               is first loaded by the inet service.
```

Appendix A - Application Source Code

```
*
*/
void TermInit(void)
{
    EnterCriticalSection(&TermCriticalSection);

    Term.iMasterSyncId = 1;
    Term.iNumEntries = Reg.dwMaxConnections+1;

    Term.pClientData = NULL;
    Term.pClientData = (PCLIENTDATA)malloc(Term.iNumEntries *
sizeof(CLIENTDATA));
    if (Term.pClientData == NULL)
    {
        LeaveCriticalSection(&TermCriticalSection);
        throw new CWEBCLNT_ERR( ERR_MEM_ALLOC_FAILED );
    }

    ZeroMemory( Term.pClientData, Term.iNumEntries * sizeof(CLIENTDATA) );

    Term.iFreeList = Term.iNumEntries-1;
    // build free list
    // note: Term.pClientData[0].iNextFree gets set to -1, which marks it as "in
use".
    // This is intentional, as the zero entry is used as an anchor and never
    // allocated as an actual terminal.
    for(int i=0; i<Term.iNumEntries; i++)
        Term.pClientData[i].iNextFree = i-1;

    LeaveCriticalSection(&TermCriticalSection);
}

/* FUNCTION: TermDeleteAll
*
* PURPOSE: This function frees allocated resources associated with the terminal
structure.
*
* ARGUMENTS: none
*
* RETURNS: None
*
* COMMENTS: This function is called only when the inet service unloads the
TPCC.DLL
*/
void TermDeleteAll(void)
{
    EnterCriticalSection(&TermCriticalSection);

    for(int i=1; i<Term.iNumEntries; i++)
    {
        if (Term.pClientData[i].iNextFree == -1)
            delete Term.pClientData[i].pTxn;
    }

    Term.iFreeList = 0;
    Term.iNumEntries = 0;
    if ( Term.pClientData )
        free(Term.pClientData);
    Term.pClientData = NULL;
}
```

```
        LeaveCriticalSection(&TermCriticalSection);
    }

/* FUNCTION: TermAdd
*
* PURPOSE: This function assigns a terminal id which is used to identify a
client browser.
*
* RETURNS: int assigned terminal id
*/
int TermAdd(void)
{
    DWORD i;
    int iNewTerm, iTickCount;

    if (Term.iNumEntries == 0)
        return -1;

    EnterCriticalSection(&TermCriticalSection);
    if (Term.iFreeList != 0)
    {
        // position is available
        iNewTerm = Term.iFreeList;
        Term.iFreeList = Term.pClientData[iNewTerm].iNextFree;
        Term.pClientData[iNewTerm].iNextFree = -1; // indicates this
position is in use
    }
    else
    {
        // no open slots, so find the slot that hasn't been used in the
longest time and reuse it
        for(iNewTerm=1, i=1, iTickCount=0x7FFFFFFF; i<Reg.dwMaxConnections;
i++)
        {
            if (iTickCount > Term.pClientData[i].iTickCount)
            {
                iTickCount = Term.pClientData[i].iTickCount;
                iNewTerm = i;
            }
        }
        // if oldest term is less than one minute old, it probably means that
more connections // are being attempted than were specified as "Max Connections" at
install. In this case, // do not bump existing connection; instead, return error to
requestor.
        if ((GetTickCount() - iTickCount) < 60000)
        {
            LeaveCriticalSection(&TermCriticalSection);
            throw new CWEBCLNT_ERR( ERR_MAX_CONNECTIONS_EXCEEDED );
        }
    }

    Term.pClientData[iNewTerm].iTickCount = GetTickCount();
    Term.pClientData[iNewTerm].iSyncId = Term.iMasterSyncId++;
    Term.pClientData[iNewTerm].pTxn = NULL;

    LeaveCriticalSection(&TermCriticalSection);
    return iNewTerm;
}

/* FUNCTION: TermDelete
*
*/
```

Appendix A - Application Source Code

```
* PURPOSE:          This function makes a terminal entry in the Term array available for
reuse.
*
* ARGUMENTS:       int          id
                  Terminal id of client exiting
*
*/

void TermDelete(int id)
{
    if ( id > 0 && id < Term.iNumEntries )
    {
        delete Term.pClientData[id].pTxn;

        // put onto free list
        EnterCriticalSection(&TermCriticalSection);

        Term.pClientData[id].iNextFree = Term.iFreeList;
        Term.iFreeList = id;

        LeaveCriticalSection(&TermCriticalSection);
    }
}

/* FUNCTION: MakeErrorForm
*/

void ErrorForm(EXTENSION_CONTROL_BLOCK *pECB, int iType, int iErrorNum, int iTermId, int
iSyncId, char *szErrorText, char *szBuffer )
{
    sprintf(szBuffer,
"HTML<HEAD><TITLE>TPC-C Error</TITLE></HEAD><BODY>"
"FORM ACTION=\"tpcc.dll\" METHOD=\"GET\">"
"<INPUT TYPE=\"hidden\" NAME=\"STATUSID\" VALUE=\"%d\">"
"<INPUT TYPE=\"hidden\" NAME=\"ERROR\" VALUE=\"%d\">"
"<INPUT TYPE=\"hidden\" NAME=\"FORMID\" VALUE=\"%d\">"
"<INPUT TYPE=\"hidden\" NAME=\"TERMIN\" VALUE=\"%d\">"
"<INPUT TYPE=\"hidden\" NAME=\"SYNCID\" VALUE=\"%d\">"
"<BOLD>An Error Occurred</BOLD><BR><BR>"
"%s"
"<BR><BR><HR>"
"<INPUT TYPE=\"submit\" NAME=\"CMD\" VALUE=\"..NewOrder..\">"
"<INPUT TYPE=\"submit\" NAME=\"CMD\" VALUE=\"..Payment..\">"
"<INPUT TYPE=\"submit\" NAME=\"CMD\" VALUE=\"..Delivery..\">"
"<INPUT TYPE=\"submit\" NAME=\"CMD\" VALUE=\"..Order-Status..\">"
"<INPUT TYPE=\"submit\" NAME=\"CMD\" VALUE=\"..Stock-Level..\">"
"<INPUT TYPE=\"submit\" NAME=\"CMD\" VALUE=\"..Exit..\">"
"</FORM></BODY></HTML>"
, iType, iErrorNum, MAIN_MENU_FORM, iTermId, iSyncId, szErrorText );
}

/* FUNCTION: MakeMainMenuForm
*/

void MakeMainMenuForm(int iTermId, int iSyncId, char *szForm)
{
    sprintf(szForm,
"HTML<HEAD><TITLE>TPC-C Main Menu</TITLE></HEAD><BODY>"
"Select Desired Transaction.<BR><HR>"
"FORM ACTION=\"tpcc.dll\" METHOD=\"GET\">"
"<INPUT TYPE=\"hidden\" NAME=\"STATUSID\" VALUE=\"%0\">"
"<INPUT TYPE=\"hidden\" NAME=\"ERROR\" VALUE=\"%0\">"

```

```
"<INPUT TYPE=\"hidden\" NAME=\"FORMID\" VALUE=\"%d\">"
"<INPUT TYPE=\"hidden\" NAME=\"TERMIN\" VALUE=\"%d\">"
"<INPUT TYPE=\"hidden\" NAME=\"SYNCID\" VALUE=\"%d\">"
"<INPUT TYPE=\"submit\" NAME=\"CMD\" VALUE=\"..NewOrder..\">"
"<INPUT TYPE=\"submit\" NAME=\"CMD\" VALUE=\"..Payment..\">"
"<INPUT TYPE=\"submit\" NAME=\"CMD\" VALUE=\"..Delivery..\">"
"<INPUT TYPE=\"submit\" NAME=\"CMD\" VALUE=\"..Order-Status..\">"
"<INPUT TYPE=\"submit\" NAME=\"CMD\" VALUE=\"..Stock-Level..\">"
"<INPUT TYPE=\"submit\" NAME=\"CMD\" VALUE=\"..Exit..\">"
"</FORM></BODY></HTML>"
, MAIN_MENU_FORM, iTermId, iSyncId);
}

/* FUNCTION: MakeStockLevelForm
*
* PURPOSE:          This function constructs the Stock Level HTML page.
*
* COMMENTS:        The internal client buffer is created when the terminal id is
assigned and should not
                    be freed except when the client terminal id is no
longer needed.
*/

void MakeStockLevelForm(int iTermId, STOCK_LEVEL_DATA *pStockLevelData, BOOL bInput, char
*szForm)
{
    int c;

    c = sprintf(szForm,
"HTML<HEAD><TITLE>TPC-C Stock Level</TITLE></HEAD><FORM
ACTION=\"tpcc.dll\" METHOD=\"GET\">"
"<INPUT TYPE=\"hidden\" NAME=\"STATUSID\" VALUE=\"%0\">"
"<INPUT TYPE=\"hidden\" NAME=\"ERROR\" VALUE=\"%0\">"
"<INPUT TYPE=\"hidden\" NAME=\"FORMID\" VALUE=\"%d\">"
"<INPUT TYPE=\"hidden\" NAME=\"TERMIN\" VALUE=\"%d\">"
"<INPUT TYPE=\"hidden\" NAME=\"SYNCID\" VALUE=\"%d\">"
Level<BR>"
"Warehouse: %4.4d District: %2.2d<BR><BR>",
STOCK_LEVEL_FORM, iTermId, Term.pClientData[iTermId].iSyncId,
Term.pClientData[iTermId].w_id, Term.pClientData[iTermId].d_id);

    if ( bInput )
    {
        strcpy(szForm+c,
"Stock Level Threshold: <INPUT NAME=\"TT*\" SIZE=2><BR>"
"low stock: </font><BR> <BR> <BR> <BR> <BR> <BR> <BR>"
" <BR> <BR> <BR> <BR> <BR> <BR> <BR></PRE><HR>"
"<INPUT TYPE=\"submit\" NAME=\"CMD\" VALUE=\"Process\">"
"<INPUT TYPE=\"submit\" NAME=\"CMD\" VALUE=\"Menu\">"
"</FORM></HTML>" );
    }
    else
    {
        sprintf(szForm+c,
"Stock Level Threshold: %2.2d<BR> <BR>"
"low stock: %3.3d</font> <BR> <BR> <BR> <BR> <BR> <BR> <BR>"
" <BR> <BR> <BR> <BR> <BR> <BR> <BR></PRE><HR>"
"<INPUT TYPE=\"submit\" NAME=\"CMD\"
VALUE=\"..NewOrder..\">"

```

Appendix A - Application Source Code

```

VALUE="..Payment..">"
" <INPUT TYPE="submit" NAME="CMD"
VALUE="..Delivery..">"
" <INPUT TYPE="submit" NAME="CMD"
Status..">"
" <INPUT TYPE="submit" NAME="CMD" VALUE="..Order-
Level..">"
" <INPUT TYPE="submit" NAME="CMD" VALUE="..Stock-
" <INPUT TYPE="submit" NAME="CMD" VALUE="..Exit..">"
" </FORM></HTML>"
, pStockLevelData->threshold, pStockLevelData->low_stock);
}
}
/* FUNCTION: MakeNewOrderForm
*
* COMMENTS: The internal client buffer is created when the terminal id is
assigned and should not
*
* be freed except when the client terminal id is no
longer needed.
*/
void MakeNewOrderForm(int iTermId, NEW_ORDER_DATA *pNewOrderData, BOOL bInput, char
*szForm)
{
int i, c;
BOOL bValid;
static char szBR[] = "<BR> <BR> <BR> <BR> <BR> <BR> <BR> <BR> <BR> <BR> <BR> <BR> <BR> <BR> <BR> <BR> <BR> <BR>";
if (!bInput)
assert( pNewOrderData->exec_status_code == eOK || pNewOrderData-
>exec_status_code == eInvalidItem );
bValid = (bInput || (pNewOrderData->exec_status_code == eOK));
c = sprintf(szForm,
"<HTML><HEAD><TITLE>TPC-C New Order</TITLE></HEAD><BODY>"
"<FORM ACTION="tpcc.dll" METHOD="GET">"
"<INPUT TYPE="hidden" NAME="STATUSID" VALUE="%d">"
"<INPUT TYPE="hidden" NAME="ERROR" VALUE="0">"
"<INPUT TYPE="hidden" NAME="FORMID" VALUE="%d">"
"<INPUT TYPE="hidden" NAME="TERMID" VALUE="%d">"
"<INPUT TYPE="hidden" NAME="SYNCID" VALUE="%d">"
"<PRE><font face="Courier">
New
Order<BR>"
, bValid ? 0 : ERR_BAD_ITEM_ID, NEW_ORDER_FORM, iTermId,
Term.pClientData[iTermId].iSyncId);
if ( bInput )
{
c += sprintf(szForm+c, "Warehouse: %4.4d ",
Term.pClientData[iTermId].w_id );
strcpy( szForm+c,
"District: <INPUT NAME="DID*" SIZE=1>
"Customer: <INPUT NAME="CID*" SIZE=4> Name:
%2s ",
"Order Number: Number of Lines: W_tax:
" Supp_W Item_Id Item Name Qty Stock
B/G Price Amount<BR>"

```

```

SIZE=6> <INPUT NAME="SP00*" SIZE=4> <INPUT NAME="IID00*"
<INPUT NAME="Qty00*" SIZE=1><BR>"
SIZE=6> <INPUT NAME="SP01*" SIZE=4> <INPUT NAME="IID01*"
<INPUT NAME="Qty01*" SIZE=1><BR>"
SIZE=6> <INPUT NAME="SP02*" SIZE=4> <INPUT NAME="IID02*"
<INPUT NAME="Qty02*" SIZE=1><BR>"
SIZE=6> <INPUT NAME="SP03*" SIZE=4> <INPUT NAME="IID03*"
<INPUT NAME="Qty03*" SIZE=1><BR>"
SIZE=6> <INPUT NAME="SP04*" SIZE=4> <INPUT NAME="IID04*"
<INPUT NAME="Qty04*" SIZE=1><BR>"
SIZE=6> <INPUT NAME="SP05*" SIZE=4> <INPUT NAME="IID05*"
<INPUT NAME="Qty05*" SIZE=1><BR>"
SIZE=6> <INPUT NAME="SP06*" SIZE=4> <INPUT NAME="IID06*"
<INPUT NAME="Qty06*" SIZE=1><BR>"
SIZE=6> <INPUT NAME="SP07*" SIZE=4> <INPUT NAME="IID07*"
<INPUT NAME="Qty07*" SIZE=1><BR>"
SIZE=6> <INPUT NAME="SP08*" SIZE=4> <INPUT NAME="IID08*"
<INPUT NAME="Qty08*" SIZE=1><BR>"
SIZE=6> <INPUT NAME="SP09*" SIZE=4> <INPUT NAME="IID09*"
<INPUT NAME="Qty09*" SIZE=1><BR>"
SIZE=6> <INPUT NAME="SP10*" SIZE=4> <INPUT NAME="IID10*"
<INPUT NAME="Qty10*" SIZE=1><BR>"
SIZE=6> <INPUT NAME="SP11*" SIZE=4> <INPUT NAME="IID11*"
<INPUT NAME="Qty11*" SIZE=1><BR>"
SIZE=6> <INPUT NAME="SP12*" SIZE=4> <INPUT NAME="IID12*"
<INPUT NAME="Qty12*" SIZE=1><BR>"
SIZE=6> <INPUT NAME="SP13*" SIZE=4> <INPUT NAME="IID13*"
<INPUT NAME="Qty13*" SIZE=1><BR>"
SIZE=6> <INPUT NAME="SP14*" SIZE=4> <INPUT NAME="IID14*"
<INPUT NAME="Qty14*" SIZE=1><BR>"
"Execution Status:
Total:<BR>"
}
else
{
c += sprintf(szForm+c, "Warehouse: %4.4d District: %2.2d
pNewOrderData->w_id,
pNewOrderData->d_id);
if ( bValid )
{
c += sprintf(szForm+c, "%2.2d-%2.2d-%4.4d
%2.2d:%2.2d:%2.2d",
pNewOrderData->o_entry_d.day,
pNewOrderData->o_entry_d.month,
pNewOrderData->o_entry_d.year,
pNewOrderData->o_entry_d.hour,
pNewOrderData->o_entry_d.minute,
pNewOrderData->o_entry_d.second);
}
c += sprintf(szForm+c, "<BR>Customer: %4.4d Name: %-16s Credit:
%-2s ",
pNewOrderData->c_id, pNewOrderData->c_last, pNewOrderData-
>c_credit);
if ( bValid )

```

Appendix A - Application Source Code

```

    {
        c += sprintf(szForm+c,
                    "%Disc: %5.2f
<BR>"
                    "Order Number: %8.8d Number
of Lines: %2.2d      W_tax: %5.2f  D_tax: %5.2f <BR> <BR>"
                    " Supp_W Item_Id Item Name
Qty Stock B/G Price  Amount<BR>",
                    100.0*pNewOrderData->c_discount,
                    pNewOrderData->o_id,
                    pNewOrderData->o_ol_cnt,
                    100.0 * pNewOrderData->w_tax,
                    100.0 * pNewOrderData->d_tax);

        for(i=0; i<pNewOrderData->o_ol_cnt; i++)
        {
            c += sprintf(szForm+c, " %4.4d %6.6d %-24s
%2.2d %3.3d %1.1s  $%6.2f  $%7.2f <BR>",
                        pNewOrderData->OL[i].ol_supply_w_id,
                        pNewOrderData->OL[i].ol_i_id,
                        pNewOrderData->OL[i].ol_i_name,
                        pNewOrderData->OL[i].ol_quantity,
                        pNewOrderData->OL[i].ol_stock,
                        pNewOrderData->OL[i].ol_brand_generic,
                        pNewOrderData->OL[i].ol_i_price,
                        pNewOrderData->OL[i].ol_amount );
        }
    }
    else
    {
        c += wsprintf(szForm+c,
                    "%Disc:<BR>"
                    "Order Number: %8.8d Number of Lines:
W_tax:      D_tax:<BR> <BR>"
                    " Supp_W Item_Id Item Name      Qty
Stock B/G Price  Amount<BR>"
                    , pNewOrderData->o_id);

        i = 0;

        strncpy( szForm+c, szBR, (15-i)*5 );
        c += (15-i)*5;

        if ( bValid )
            c += sprintf(szForm+c, "Execution Status: Transaction
committed.      Total:  $%8.2f ",
                        pNewOrderData->total_amount);
        else
            c += wsprintf(szForm+c, "Execution Status: Item number is
not valid.      Total:");

        strcpy(szForm+c,
            " <BR></font></PRE><HR>"
            "<INPUT TYPE=\\"submit\\" NAME=\\"CMD\\"
VALUE=\\"..NewOrder..\\">"
            "<INPUT TYPE=\\"submit\\" NAME=\\"CMD\\"
VALUE=\\"..Payment..\\">"
            "<INPUT TYPE=\\"submit\\" NAME=\\"CMD\\"
VALUE=\\"..Delivery..\\">"
            "<INPUT TYPE=\\"submit\\" NAME=\\"CMD\\" VALUE=\\"..Order-
Status..\\">"
    }
}

```

```

Level..\\">"
        "<INPUT TYPE=\\"submit\\" NAME=\\"CMD\\" VALUE=\\"..Stock-
        "<INPUT TYPE=\\"submit\\" NAME=\\"CMD\\" VALUE=\\"..Exit..\\">"
        "</FORM></HTML>"
    );
}

/* FUNCTION: MakePaymentForm
 *
 * COMMENTS:      The internal client buffer is created when the terminal id is
assigned and should not
 *
 *                  be freed except when the client terminal id is no
longer needed.
 */

void MakePaymentForm(int iTermId, PAYMENT_DATA *pPaymentData, BOOL bInput, char *szForm)
{
    int c;

    c = wsprintf(szForm,
                "<HTML><HEAD><TITLE>TPC-C Payment</TITLE></HEAD><BODY>"
                "<FORM ACTION=\\"tpcc.dll\\" METHOD=\\"GET\\">"
                "<INPUT TYPE=\\"hidden\\" NAME=\\"STATUSID\\" VALUE=\\"0\\">"
                "<INPUT TYPE=\\"hidden\\" NAME=\\"ERROR\\" VALUE=\\"0\\">"
                "<INPUT TYPE=\\"hidden\\" NAME=\\"FORMID\\" VALUE=\\"%d\\">"
                "<INPUT TYPE=\\"hidden\\" NAME=\\"TERMID\\" VALUE=\\"%d\\">"
                "<INPUT TYPE=\\"hidden\\" NAME=\\"SYNCID\\" VALUE=\\"%d\\">"
                "<PRE><font face=\\"Courier\\">"

    Payment<BR>"
        "Date: "
        , PAYMENT_FORM, iTermId, Term.pClientData[iTermId].iSyncId);

    if ( !bInput )
    {
        c += wsprintf(szForm+c, "%2.2d-%2.2d-%4.4d %2.2d:%2.2d:%2.2d",
                    pPaymentData->h_date.day,
                    pPaymentData->h_date.month,
                    pPaymentData->h_date.year,
                    pPaymentData->h_date.hour,
                    pPaymentData->h_date.minute,
                    pPaymentData->h_date.second);
    }

    if ( bInput )
    {
        c += wsprintf(szForm+c,
                    "<BR> <BR>Warehouse: %4.4d"
                    " District: <INPUT NAME=\\"DID\\"
SIZE=1><BR> <BR> <BR> <BR> <BR>"
                    "Customer: <INPUT NAME=\\"CID*\\" SIZE=4>"
                    "Cust-Warehouse: <INPUT NAME=\\"CWI*\\" SIZE=4> "
                    "Cust-District: <INPUT NAME=\\"CDI*\\" SIZE=1><BR>"
                    "Name: <INPUT NAME=\\"CLT*\\" SIZE=16>"

                    Since:<BR>"
                    "
                    Credit:<BR>"
                    "
                    Disc:<BR>"
                    "
                    Phone:<BR> <BR>"
                    "Amount Paid: $<INPUT NAME=\\"HAM*\\" SIZE=7>"

                    New Cust-Balance:<BR>"
    }
}

```

Appendix A - Application Source Code

```

                "Credit Limit:<BR> <BR>Cust-Data: <BR> <BR> <BR> <BR>
<BR></font></PRE><HR>"
                "<INPUT TYPE=\\"submit\\" NAME=\\"CMD\\"
VALUE=\\"Process\\"><INPUT TYPE=\\"submit\\" NAME=\\"CMD\\" VALUE=\\"Menu\\">"
                "</BODY></FORM></HTML>"
                , Term.pClientData[iTermId].w_id);
        }
    else
    {
        c += wsprintf(szForm+c,
                "<BR> <BR>Warehouse: %4.4d
District: %2.2d<BR>"
                "%-20s          %-20s<BR>"
                "%-20s          %-20s<BR>"
                "%-20s %-2s %5.5s-%4.4s          %-20s %-2s %5.5s-%4.4s<BR>"
                "%-20s          %-20s"
                "%-20s %-2s %5.5s-%4.4s          %-20s %-2s %5.5s-%4.4s<BR>"
                "<BR>"
                "%Customer: %4.4d  Cust-Warehouse: %4.4d  Cust-District:
%2.2d<BR>"
                "%Name:  %-16s %-2s %-16s          Since:  %2.2d-%2.2d-
%4.4d<BR>"
                "          %-20s          Credit:  %-2s<BR>"
                , Term.pClientData[iTermId].w_id, pPaymentData->d_id
                , pPaymentData->w_street_1, pPaymentData->d_street_1
                , pPaymentData->w_street_2, pPaymentData->d_street_2
                , pPaymentData->w_city, pPaymentData->w_state,
                pPaymentData->w_zip, pPaymentData->w_zip+5
                , pPaymentData->d_city, pPaymentData->d_state,
                pPaymentData->d_zip, pPaymentData->d_zip+5
                , pPaymentData->c_id, pPaymentData->c_w_id,
                pPaymentData->c_d_id
                , pPaymentData->c_first, pPaymentData->c_middle,
                pPaymentData->c_last
                , pPaymentData->c_since.day, pPaymentData->c_since.month,
                pPaymentData->c_since.year
                , pPaymentData->c_street_1, pPaymentData->c_credit
                );
        c += sprintf(szForm+c,
                "          %-20s          %%Disc:  %5.2f<BR>",
                pPaymentData->c_street_2, 100.0*pPaymentData->c_discount);
        c += wsprintf(szForm+c,
                "          %-20s %-2s %5.5s-%4.4s          Phone:  %6.6s-%3.3s-
%3.3s-%4.4s<BR> <BR>"
                , pPaymentData->c_city, pPaymentData->c_state, pPaymentData-
>c_zip, pPaymentData->c_zip+5,
                pPaymentData->c_phone, pPaymentData->c_phone+6,
                pPaymentData->c_phone+9, pPaymentData->c_phone+12 );
        c += sprintf(szForm+c,
                "Amount Paid:          %7.2f          New Cust-Balance:
$%14.2f<BR>"
                "Credit Limit:  $%13.2f<BR> <BR>"
                , pPaymentData->h_amount, pPaymentData->c_balance
                , pPaymentData->c_credit_lim
                );
        if ( pPaymentData->c_credit[0] == 'B' && pPaymentData->c_credit[1] ==
' C ' )
            c += wsprintf(szForm+c,
                "Cust-Data: %>50.50s<BR>          %>
50.50s<BR>          %>50.50s<BR>"

```

```

                pPaymentData->c_data, pPaymentData-
>c_data+50, pPaymentData->c_data+100, pPaymentData->c_data+150 );
        else
            strcpy(szForm+c, "Cust-Data: <BR> <BR> <BR> <BR>");
            strcat(szForm, " <BR></font></PRE><HR>"
                "<INPUT TYPE=\\"submit\\"
                "<INPUT TYPE=\\"submit\\"
                "<INPUT TYPE=\\"submit\\"
                "<INPUT TYPE=\\"submit\\"
                "<INPUT TYPE=\\"submit\\"
                "<INPUT TYPE=\\"submit\\"
                "</BODY></FORM></HTML>");
        }
    }
    /* FUNCTION: MakeOrderStatusForm
    *
    * COMMENTS: The internal client buffer is created when the terminal id is
    assigned and should not be freed except when the client terminal id is no
    longer needed.
    */
void MakeOrderStatusForm(int iTermId, ORDER_STATUS_DATA *pOrderStatusData, BOOL bInput,
char *szForm)
{
    int i, c;
    static char szBR[] = " <BR> <BR> <BR> <BR> <BR> <BR> <BR> <BR> <BR> <BR> <BR> <BR> <BR> <BR> <BR>";
    c = wsprintf(szForm,
        "<HTML><HEAD><TITLE>TPC-C Order-Status</TITLE></HEAD><BODY>"
        "<FORM ACTION=\\"tpcc.dll\\" METHOD=\\"GET\\">"
        "<INPUT TYPE=\\"hidden\\" NAME=\\"STATUSID\\" VALUE=\\"0\\">"
        "<INPUT TYPE=\\"hidden\\" NAME=\\"ERROR\\" VALUE=\\"0\\">"
        "<INPUT TYPE=\\"hidden\\" NAME=\\"FORMID\\" VALUE=\\"%d\\">"
        "<INPUT TYPE=\\"hidden\\" NAME=\\"TERMINID\\" VALUE=\\"%d\\">"
        "<INPUT TYPE=\\"hidden\\" NAME=\\"SYNCID\\" VALUE=\\"%d\\">"
        "<PRE><font face=\\"Courier\\">"
        Order-
        Status<BR>"
        "Warehouse: %4.4d ",
        ORDER_STATUS_FORM, iTermId, Term.pClientData[iTermId].iSyncId,
        Term.pClientData[iTermId].w_id);
        if ( bInput )
        {
            strcpy(szForm+c,
                "District: <INPUT NAME=\\"DID*\\" SIZE=1><BR>"
                "Customer: <INPUT NAME=\\"CID*\\" SIZE=4> Name:
<INPUT NAME=\\"CLT*\\" SIZE=23><BR>"
                "Cust-Balance:<BR> <BR>"
                "Order-Number:          Entry-Date:
Carrier-Number:<BR>"
                "Supply-W Item-Id Qty Amount Delivery-
Date<BR> <BR> <BR> <BR> <BR>"

```

Appendix A - Application Source Code

```

    " <BR> <BR> <BR> <BR> <BR> <BR> <BR> <BR> <BR> <BR> <BR>
<BR></font></PRE>"
    "<HR><INPUT TYPE=\"submit\" NAME=\"CMD\"
VALUE=\"Process\"><INPUT TYPE=\"submit\" NAME=\"CMD\" VALUE=\"Menu\">"
    "</BODY></FORM></HTML\" );
}
else
{
    c += sprintf(szForm+c,
        "District: %2.2d<BR>"
        "Customer: %4.4d Name: %-16s %-2s %-16s<BR>",
        pOrderStatusData->d_id, pOrderStatusData->c_id,
        pOrderStatusData->c_first, pOrderStatusData->c_middle,
pOrderStatusData->c_last);

    c += sprintf(szForm+c, "Cust-Balance: $%9.2f<BR> <BR>",
        pOrderStatusData->c_balance);

    c += sprintf(szForm+c,
        "Order-Number: %8.8d Entry-Date: %2.2d-%2.2d-%4.4d
%2.2d:%2.2d:%2.2d Carrier-Number: %2.2d<BR>"
        "Supply-W Item-Id Qty Amount Delivery-
Date<BR>",
        pOrderStatusData->o_id,
        pOrderStatusData->o_entry_d.day,
        pOrderStatusData->o_entry_d.month,
        pOrderStatusData->o_entry_d.year,
        pOrderStatusData->o_entry_d.hour,
        pOrderStatusData->o_entry_d.minute,
        pOrderStatusData->o_entry_d.second,
        pOrderStatusData->o_carrier_id);

    for(i=0; i< pOrderStatusData->o_ol_cnt; i++)
    {
        c += sprintf(szForm+c, " %4.4d %6.6d %2.2d
$%8.2f %2.2d-%2.2d-%4.4d<BR>",
            pOrderStatusData->OL[i].ol_supply_w_id,
            pOrderStatusData->OL[i].ol_i_id,
            pOrderStatusData->OL[i].ol_quantity,
            pOrderStatusData->OL[i].ol_amount,
            pOrderStatusData->OL[i].ol_delivery_d.day,
            pOrderStatusData->OL[i].ol_delivery_d.month,
            pOrderStatusData->OL[i].ol_delivery_d.year);
    }

    strcpy( szForm+c, szBR, (15-i)*5 );
    c += (15-i)*5;

    strcpy(szForm+c,
        "</font></PRE><HR><INPUT TYPE=\"submit\" NAME=\"CMD\"
VALUE=\"..NewOrder..\">"
        "<INPUT TYPE=\"submit\" NAME=\"CMD\"
VALUE=\"..Payment..\">"
        "<INPUT TYPE=\"submit\" NAME=\"CMD\"
VALUE=\"..Delivery..\">"
        "<INPUT TYPE=\"submit\" NAME=\"CMD\" VALUE=\"..Order-
Status..\">"
        "<INPUT TYPE=\"submit\" NAME=\"CMD\" VALUE=\"..Stock-
Level..\">"
        "<INPUT TYPE=\"submit\" NAME=\"CMD\" VALUE=\"..Exit..\">"
        "</BODY></FORM></HTML\" );
}
}

```

```

/* FUNCTION: MakeDeliveryForm
*
* COMMENTS: The internal client buffer is created when the terminal id is
* assigned and should not be freed except when the client terminal id is no
* longer needed.
*/

void MakeDeliveryForm(int iTermId, DELIVERY_DATA *pDeliveryData, BOOL bInput, char
*szForm)
{
    int c;

    c = sprintf(szForm,
        "<HTML><HEAD><TITLE>TPC-C Delivery</TITLE></HEAD><BODY>"
        "<FORM ACTION=\"tpcc.dll\" METHOD=\"GET\">"
        "<INPUT TYPE=\"hidden\" NAME=\"STATUSID\" VALUE=\"%d\">"
        "<INPUT TYPE=\"hidden\" NAME=\"ERROR\" VALUE=\"0\">"
        "<INPUT TYPE=\"hidden\" NAME=\"FORMID\" VALUE=\"%d\">"
        "<INPUT TYPE=\"hidden\" NAME=\"TERMINID\" VALUE=\"%d\">"
        "<INPUT TYPE=\"hidden\" NAME=\"SYNCID\" VALUE=\"%d\">"
        "<PRE><font face=\"Courier\">"
Delivery<BR>"
        "Warehouse: %4.4d<BR> <BR>",
        (!bInput && (pDeliveryData->exec_status_code != eOK)) ?
ERR_TYPE_DELIVERY_POST : 0,
        DELIVERY_FORM, iTermId, Term.pClientData[iTermId].iSyncId,
Term.pClientData[iTermId].w_id);

    if ( bInput )
    {
        strcpy( szForm+c,
            "Carrier Number: <INPUT NAME=\"OCD\" SIZE=1><BR> <BR>"
            "Execution Status: <BR> <BR> <BR> <BR> <BR> <BR> <BR>"
            " <BR> <BR> <BR> <BR> <BR> <BR> <BR> <BR> <BR>"
        );
    }
    else
    {
        sprintf( szForm+c,
            "Carrier Number: %2.2d<BR> <BR>"
            "Execution Status: %s <BR> <BR> <BR> <BR> <BR> <BR> <BR>"
        );
    }

    VALUE=\"..NewOrder..\">"
    "<INPUT TYPE=\"submit\" NAME=\"CMD\" VALUE=\"Process\">"
    "<INPUT TYPE=\"submit\" NAME=\"CMD\" VALUE=\"Menu\">"
    "</BODY></FORM></HTML\" );
}
}

    strcpy( szForm+c,
        "Carrier Number: %2.2d<BR> <BR>"
        "Execution Status: %s <BR> <BR> <BR> <BR> <BR> <BR> <BR>"
        " <BR> <BR> <BR> <BR> <BR> <BR> <BR> <BR> <BR> <BR>"
        "<HR><INPUT TYPE=\"submit\" NAME=\"CMD\"
VALUE=\"..NewOrder..\">"
        "<INPUT TYPE=\"submit\" NAME=\"CMD\"
VALUE=\"..Payment..\">"
        "<INPUT TYPE=\"submit\" NAME=\"CMD\"
VALUE=\"..Delivery..\">"
        "<INPUT TYPE=\"submit\" NAME=\"CMD\" VALUE=\"..Order-
Status..\">"
        "<INPUT TYPE=\"submit\" NAME=\"CMD\" VALUE=\"..Stock-
Level..\">"
        "<INPUT TYPE=\"submit\" NAME=\"CMD\" VALUE=\"..Exit..\">"
        "</BODY></FORM></HTML\" );

    , pDeliveryData->o_carrier_id,

```

Appendix A - Application Source Code

```
                (pDeliveryData->exec_status_code == eOK) ? "Delivery has
been queued." : "Delivery Post Failed "
            );
        }
    }

/* FUNCTION: ProcessNewOrderForm
 *
 * PURPOSE:      This function gets and validates the input data from the new order
form
 *              filling in the required input variables. it then calls the
SQLNewOrder
 *              transaction, constructs the output form and writes it back
to client
 *              browser.
 */

void ProcessNewOrderForm(EXTENSION_CONTROL_BLOCK *pECB, int iTermId, char *szBuffer)
{
    PNEW_ORDER_DATA    pNewOrder;

    pNewOrder = Term.pClientData[iTermId].pTxn->BuffAddr_NewOrder();

    ZeroMemory(pNewOrder, sizeof(NEW_ORDER_DATA));
    pNewOrder->w_id = Term.pClientData[iTermId].w_id;
    GetNewOrderData(pECB->lpszQueryString, pNewOrder);

    Term.pClientData[iTermId].pTxn->NewOrder();

    pNewOrder = Term.pClientData[iTermId].pTxn->BuffAddr_NewOrder();
    MakeNewOrderForm(iTermId, pNewOrder, OUTPUT_FORM, szBuffer );
}

/* FUNCTION: void ProcessPaymentForm
 *
 * PURPOSE:      This function gets and validates the input data from the payment form
 *              filling in the required input variables. It then calls the
SQLPayment
 *              transaction, constructs the output form and writes it back
to client
 *              browser.
 *
 * ARGUMENTS:    EXTENSION_CONTROL_BLOCK    *pECB    passed in structure pointer
from inetsrv.
 *              int
 *              iTermId    client browser terminal id
 */

void ProcessPaymentForm(EXTENSION_CONTROL_BLOCK *pECB, int iTermId, char *szBuffer)
{
    PPAYMENT_DATA    pPayment;

    pPayment = Term.pClientData[iTermId].pTxn->BuffAddr_Payment();
    ZeroMemory(pPayment, sizeof(PAYMENT_DATA));
    pPayment->w_id = Term.pClientData[iTermId].w_id;
    GetPaymentData(pECB->lpszQueryString, pPayment);

    Term.pClientData[iTermId].pTxn->Payment();

    pPayment = Term.pClientData[iTermId].pTxn->BuffAddr_Payment();
    MakePaymentForm(iTermId, pPayment, OUTPUT_FORM, szBuffer);
}
```

```
/* FUNCTION: ProcessOrderStatusForm
 *
 * PURPOSE:      This function gets and validates the input data from the Order Status
 *              form filling in the required input variables. It then calls
the
 *              SQLOrderStatus transaction, constructs the output form and
writes it
 *              back to client browser.
 *
 * ARGUMENTS:    EXTENSION_CONTROL_BLOCK    *pECB    passed in structure pointer
from inetsrv.
 *              int
 *              iTermId    client browser terminal id
 */

void ProcessOrderStatusForm(EXTENSION_CONTROL_BLOCK *pECB, int iTermId, char *szBuffer)
{
    PORDER_STATUS_DATA pOrderStatus;

    pOrderStatus = Term.pClientData[iTermId].pTxn->BuffAddr_OrderStatus();
    ZeroMemory(pOrderStatus, sizeof(ORDER_STATUS_DATA));
    pOrderStatus->w_id = Term.pClientData[iTermId].w_id;
    GetOrderStatusData(pECB->lpszQueryString, pOrderStatus);

    Term.pClientData[iTermId].pTxn->OrderStatus();

    pOrderStatus = Term.pClientData[iTermId].pTxn->BuffAddr_OrderStatus();
    MakeOrderStatusForm(iTermId, pOrderStatus, OUTPUT_FORM, szBuffer);
}

/* FUNCTION: ProcessDeliveryForm
 *
 * PURPOSE:      This function gets and validates the input data from the delivery
form
 *              filling in the required input variables. It then calls the
PostDeliveryInfo
 *              Api, The client is then informed that the transaction has
been posted.
 *
 * ARGUMENTS:    EXTENSION_CONTROL_BLOCK    *pECB    passed in structure pointer
from inetsrv.
 *              int
 *              iTermId    client browser terminal id
 */

void ProcessDeliveryForm(EXTENSION_CONTROL_BLOCK *pECB, int iTermId, char *szBuffer)
{
    char    *ptr = pECB->lpszQueryString;

    PDELIVERY_DATA    pDelivery;

    pDelivery = Term.pClientData[iTermId].pTxn->BuffAddr_Delivery();
    ZeroMemory(pDelivery, sizeof(DELIVERY_DATA));
    pDelivery->w_id = Term.pClientData[iTermId].w_id;

    pDelivery->o_carrier_id = GetIntKeyValue(&ptr, "OCD*",
ERR_DELIVERY_MISSING_OCD_KEY, ERR_DELIVERY_CARRIER_INVALID);
    if ( pDelivery->o_carrier_id > 10 || pDelivery->o_carrier_id < 1 )
        throw new CWEBCLNT_ERR( ERR_DELIVERY_CARRIER_ID_RANGE );
}
```

Appendix A - Application Source Code

```
if (dwNumDeliveryThreads)
{
    //post delivery info
    if ( PostDeliveryInfo(pDelivery->w_id, pDelivery->o_carrier_id) )
        pDelivery->exec_status_code = eDeliveryFailed;
    else
        pDelivery->exec_status_code = eOK;
}
else // delivery is done synchronously if no delivery threads configured
    Term.pClientData[iTermId].pTxn->Delivery();

pDelivery = Term.pClientData[iTermId].pTxn->BuffAddr_Delivery();
MakeDeliveryForm(iTermId, pDelivery, OUTPUT_FORM, szBuffer);
}

/* FUNCTION: ProcessStockLevelForm
 *
 * PURPOSE:      This function gets and validates the input data from the Stock Level
 *               form filling in the required input variables. It then calls
 *               the SQLStockLevel transaction, constructs the output form and
 *               writes it back to client browser.
 *
 * ARGUMENTS:    EXTENSION_CONTROL_BLOCK *pECB    passed in structure pointer
 *               from inetsrv.
 *               int iTermId                       client browser terminal id
 *
 */

void ProcessStockLevelForm(EXTENSION_CONTROL_BLOCK *pECB, int iTermId, char *szBuffer)
{
    char *ptr = pECB->lpszQueryString;

    PSTOCK_LEVEL_DATA pStockLevel;

    pStockLevel = Term.pClientData[iTermId].pTxn->BuffAddr_StockLevel();
    ZeroMemory( pStockLevel, sizeof(STOCK_LEVEL_DATA) );

    pStockLevel->w_id = Term.pClientData[iTermId].w_id;
    pStockLevel->d_id = Term.pClientData[iTermId].d_id;

    pStockLevel->threshold = GetIntKeyValue(&ptr, "TT",
ERR_STOCKLEVEL_MISSING_THRESHOLD_KEY, ERR_STOCKLEVEL_THRESHOLD_INVALID);
    if ( pStockLevel->threshold >= 100 || pStockLevel->threshold < 0 )
        throw new CWEBCLNT_ERR( ERR_STOCKLEVEL_THRESHOLD_RANGE );

    Term.pClientData[iTermId].pTxn->StockLevel();

    pStockLevel = Term.pClientData[iTermId].pTxn->BuffAddr_StockLevel();
    MakeStockLevelForm(iTermId, pStockLevel, OUTPUT_FORM, szBuffer);
}

/* FUNCTION: GetNewOrderData
 *
 * PURPOSE:      This function extracts and validates the new order form data from an
 *               http command string.
 *
 * ARGUMENTS:    LPSTR lpszQueryString           client
 *               browser http command string
 *               NEW_ORDER_DATA *pNewOrderData
 *               pointer to new order data structure
 */
```

```
*
*/

void GetNewOrderData(LPSTR lpszQueryString, NEW_ORDER_DATA *pNewOrderData)
{
    char szTmp[26];
    int i;
    short items;
    int ol_i_id, ol_quantity;
    char *ptr = lpszQueryString;

    static char szSP[MAX_OL_NEW_ORDER_ITEMS][6] =
    { "SP00*", "SP01*", "SP02*", "SP03*", "SP04*",
      "SP05*", "SP06*", "SP07*", "SP08*", "SP09*",
      "SP10*", "SP11*", "SP12*", "SP13*", "SP14*" };
    static char szIID[MAX_OL_NEW_ORDER_ITEMS][7] =
    { "IID00*", "IID01*", "IID02*", "IID03*", "IID04*",
      "IID05*", "IID06*", "IID07*", "IID08*", "IID09*",
      "IID10*", "IID11*", "IID12*", "IID13*", "IID14*" };
    static char szQty[MAX_OL_NEW_ORDER_ITEMS][7] =
    { "Qty00*", "Qty01*", "Qty02*", "Qty03*", "Qty04*",
      "Qty05*", "Qty06*", "Qty07*", "Qty08*", "Qty09*",
      "Qty10*", "Qty11*", "Qty12*", "Qty13*", "Qty14*" };

    pNewOrderData->d_id = GetIntKeyValue(&ptr, "DID*",
ERR_NEWORDER_FORM_MISSING_DID, ERR_NEWORDER_DISTRICT_INVALID);
    pNewOrderData->c_id = GetIntKeyValue(&ptr, "CID*", ERR_NEWORDER_CUSTOMER_KEY,
ERR_NEWORDER_CUSTOMER_INVALID);

    for(i=0, items=0; i<MAX_OL_NEW_ORDER_ITEMS; i++)
    {
        GetKeyValue(&ptr, szSP[i], szTmp, sizeof(szTmp),
ERR_NEWORDER_MISSING_SUPPW_KEY);
        if ( szTmp[0] )
        {
            if ( !IsNumeric(szTmp) )
                throw new CWEBCLNT_ERR(
ERR_NEWORDER_SUPPW_INVALID );
            pNewOrderData->OL[items].ol_supply_w_id =
(short)atoi(szTmp);

            ol_i_id = pNewOrderData->OL[items].ol_i_id =
GetIntKeyValue(&ptr, szIID[i],
ERR_NEWORDER_MISSING_IID_KEY, ERR_NEWORDER_ITEMID_INVALID);
            if ( ol_i_id > 999999 || ol_i_id < 1 )
                throw new CWEBCLNT_ERR( ERR_NEWORDER_ITEMID_RANGE );

            ol_quantity = pNewOrderData->OL[items].ol_quantity =
GetIntKeyValue(&ptr, szQty[i],
ERR_NEWORDER_MISSING_QTY_KEY, ERR_NEWORDER_QTY_INVALID);
            if ( ol_quantity > 99 || ol_quantity < 1 )
                throw new CWEBCLNT_ERR( ERR_NEWORDER_QTY_RANGE );

            items++;
        }
        else
        {
            // nothing entered for supply warehouse, so item id and qty
            must also be blank
            GetKeyValue(&ptr, szIID[i], szTmp, sizeof(szTmp),
ERR_NEWORDER_MISSING_IID_KEY);
            if ( szTmp[0] )

```

Appendix A - Application Source Code

```
throw new CWEBClnt_Err(
ERR_NEWORDER_ITEMID_WITHOUT_SUPPW );

    GetKeyValue(&ptr, szQty[i], szTmp, sizeof(szTmp),
ERR_NEWORDER_MISSING_QTY_KEY);
    if ( szTmp[0] )
        throw new CWEBClnt_Err(
ERR_NEWORDER_QTY_WITHOUT_SUPPW );
    }
    if ( items == 0 )
        throw new CWEBClnt_Err( ERR_NEWORDER_NOITEMS_ENTERED );

    pNewOrderData->o_ol_cnt = items;
}

/* FUNCTION: GetPaymentData
 *
 * PURPOSE:      This function extracts and validates the payment form data from an
http command string.
 *
 * ARGUMENTS:    LPSTR                lpszQueryString        client
browser http command string          PAYMENT_DATA          *pPaymentData
pointer to payment data structure
 */

void GetPaymentData(LPSTR lpszQueryString, PAYMENT_DATA *pPaymentData)
{
    char    szTmp[26];
    char    *ptr = lpszQueryString;
    BOOL    bCustIdBlank;

    pPaymentData->d_id = GetIntKeyValue(&ptr, "DID*", ERR_PAYMENT_MISSING_DID_KEY,
ERR_PAYMENT_DISTRICT_INVALID);

    GetKeyValue(&ptr, "CID*", szTmp, sizeof(szTmp), ERR_PAYMENT_MISSING_CID_KEY);
    if ( szTmp[0] == 0 )
    {
        bCustIdBlank = TRUE;
        pPaymentData->c_id = 0;
    }
    else
    {
        // parse customer id and verify that last name was NOT entered
        bCustIdBlank = FALSE;
        if ( !IsNumeric(szTmp) )
            throw new CWEBClnt_Err( ERR_PAYMENT_CUSTOMER_INVALID );
        pPaymentData->c_id = atoi(szTmp);
    }

    pPaymentData->c_w_id = GetIntKeyValue(&ptr, "CWI*",
ERR_PAYMENT_MISSING_CWI_KEY, ERR_PAYMENT_CWI_INVALID);
    pPaymentData->c_d_id = GetIntKeyValue(&ptr, "CDI*",
ERR_PAYMENT_MISSING_CDI_KEY, ERR_PAYMENT_CDI_INVALID);

    if ( bCustIdBlank )
    {
        // customer id is blank, so last name must be entered
        GetKeyValue(&ptr, "CLT*", szTmp, sizeof(szTmp),
ERR_PAYMENT_MISSING_CLT_KEY);
        if ( szTmp[0] == 0 )
            throw new CWEBClnt_Err( ERR_PAYMENT_MISSING_CID_CLT );

        _strupr( szTmp );
    }
}
```

```
if ( strlen(pPaymentData->c_last) > LAST_NAME_LEN )
    throw new CWEBClnt_Err( ERR_PAYMENT_LAST_NAME_TO_LONG );
strcpy(pPaymentData->c_last, szTmp);
}
else
{
    // parse customer id and verify that last name was NOT entered
    GetKeyValue(&ptr, "CLT*", szTmp, sizeof(szTmp),
ERR_PAYMENT_MISSING_CLT_KEY);
    if ( szTmp[0] != 0 )
        throw new CWEBClnt_Err( ERR_PAYMENT_CID_AND_CLT );
}

    GetKeyValue(&ptr, "HAM*", szTmp, sizeof(szTmp), ERR_PAYMENT_MISSING_HAM_KEY);
    if (!IsDecimal(szTmp))
        throw new CWEBClnt_Err( ERR_PAYMENT_HAM_INVALID );
    pPaymentData->h_amount = atof(szTmp);
    if ( pPaymentData->h_amount >= 10000.00 || pPaymentData->h_amount < 0 )
        throw new CWEBClnt_Err( ERR_PAYMENT_HAM_RANGE );
}

/* FUNCTION: GetOrderStatusData
 *
 * PURPOSE:      This function extracts and validates the payment form data from an
http command string.
 *
 */
void GetOrderStatusData(LPSTR lpszQueryString, ORDER_STATUS_DATA *pOrderStatusData)
{
    char    szTmp[26];
    char    *ptr = lpszQueryString;

    pOrderStatusData->d_id = GetIntKeyValue(&ptr, "DID*",
ERR_ORDERSTATUS_MISSING_DID_KEY, ERR_ORDERSTATUS_DID_INVALID);

    GetKeyValue(&ptr, "CID*", szTmp, sizeof(szTmp),
ERR_ORDERSTATUS_MISSING_CID_KEY);
    if ( szTmp[0] == 0 )
    {
        // customer id is blank, so last name must be entered
        pOrderStatusData->c_id = 0;
        GetKeyValue(&ptr, "CLT*", szTmp, sizeof(szTmp),
ERR_ORDERSTATUS_MISSING_CLT_KEY);
        if ( szTmp[0] == 0 )
            throw new CWEBClnt_Err( ERR_ORDERSTATUS_MISSING_CID_CLT );

        _strupr( szTmp );
        if ( strlen(pOrderStatusData->c_last) > LAST_NAME_LEN )
            throw new CWEBClnt_Err( ERR_ORDERSTATUS_CLT_RANGE );
        strcpy(pOrderStatusData->c_last, szTmp);
    }
    else
    {
        // parse customer id and verify that last name was NOT entered
        if ( !IsNumeric(szTmp) )
            throw new CWEBClnt_Err( ERR_ORDERSTATUS_CID_INVALID );
        pOrderStatusData->c_id = atoi(szTmp);
        GetKeyValue(&ptr, "CLT*", szTmp, sizeof(szTmp),
ERR_ORDERSTATUS_MISSING_CLT_KEY);
        if ( szTmp[0] != 0 )
            throw new CWEBClnt_Err( ERR_ORDERSTATUS_CID_AND_CLT );
    }
}

/* FUNCTION: BOOL IsNumeric(char *ptr)
```

Appendix A - Application Source Code

```
*
* PURPOSE:      This function determines if a string is numeric. It fails if any
characters other
*              than numeric and null terminator are present.
*
* ARGUMENTS:   char          *ptr    pointer to string to check.
*
* RETURNS:     BOOL          FALSE   if string is not all numeric
*              TRUE          if string contains
only numeric characters i.e. '0' - '9'
*/

BOOL IsNumeric(char *ptr)
{
    if ( *ptr == 0 )
        return FALSE;

    while( *ptr && isdigit(*ptr) )
        ptr++;
    return ( !*ptr );
}

/* FUNCTION: BOOL IsDecimal(char *ptr)
*
* PURPOSE:      This function determines if a string is a non-negative decimal value.
*              It fails if any characters other than a series of numbers followed by
*              a decimal point, another series of numbers, and a null
terminator are present.
*
* ARGUMENTS:   char          *ptr    pointer to string to check.
*
* RETURNS:     BOOL          FALSE   if string is not a valid non-negative
decimal value
*              TRUE          if string is OK
*/

BOOL IsDecimal(char *ptr)
{
    char *dotptr;
    BOOL  bValid;

    if ( *ptr == 0 )
        return FALSE;

    // find decimal point
    dotptr = strchr( ptr, '.' );
    if (dotptr == NULL)
        // no decimal point, so just check for numeric
        return IsNumeric(ptr);
    *dotptr = 0; // temporarily replace decimal with a terminator

    if ( *ptr != 0 )
        bValid = IsNumeric(ptr);
    // string starts with decimal point
    else if (*(dotptr+1) == 0)
        return FALSE; // nothing but a decimal point is bad
    else
        bValid = TRUE;

    if (*(dotptr+1) != 0)
        // check text after decimal point
        bValid &= IsNumeric(dotptr+1);
}
```

```
*dotptr = '.'; // replace decimal point
return bValid;
}
```

isapi_dll/src/resource.h

```
//{{NO_DEPENDENCIES}}
// Microsoft Developer Studio generated include file.
// Used by tpcc.rc
//
#define IDD_DIALOG1                101

// Next default values for new objects
//
#ifdef APSTUDIO_INVOKED
#ifdef APSTUDIO_READONLY_SYMBOLS
#define _APS_NEXT_RESOURCE_VALUE    102
#define _APS_NEXT_COMMAND_VALUE    40001
#define _APS_NEXT_CONTROL_VALUE    1000
#define _APS_NEXT_SYMED_VALUE      101
#endif
#endif
```

common/src/ReadRegistry.cpp

```
/*      FILE:          READREGISTRY.CPP
*
*              Microsoft TPC-C Kit Ver. 4.20.000
*              Copyright Microsoft, 1999
*
*              All Rights Reserved
*
*              not yet audited
*
*      PURPOSE: Implementation for TPC-C Tuxedo class.
*      Contact: Charles Levine (clevine@microsoft.com)
*
*      Change history:
*              4.20.000 - first version
*/

/* FUNCTION: ReadTPCCRegistrySettings
*
* PURPOSE:      This function reads the NT registry for startup parameters. There
parameters are
*              under the TPCC key.
*
* RETURNS      FALSE = no errors
*              TRUE  = error reading registry
*/
BOOL ReadTPCCRegistrySettings( TPCCREGISTRYDATA *pReg )
{
    HKEY  hKey;
    DWORD size;
    DWORD type;
    DWORD dwTmp;
```

Appendix A - Application Source Code

```
char    szTmp[256];

if ( RegOpenKeyEx(HKEY_LOCAL_MACHINE, "SOFTWARE\\Microsoft\\TPCC", 0, KEY_READ,
&hKey) != ERROR_SUCCESS )
    return TRUE;

// determine database protocol to use; may be either ODBC or DBLIB
pReg->eDB_Protocol = Unspecified;
size = sizeof(szTmp);
if ( RegQueryValueEx(hKey, "DB_Protocol", 0, &type, (BYTE *)&szTmp, &size) ==
ERROR_SUCCESS )
{
    if ( !strcmp(szTmp, szDBNames[ODBC]) )
        pReg->eDB_Protocol = ODBC;
    else if ( !strcmp(szTmp, szDBNames[DBLIB]) )
        pReg->eDB_Protocol = DBLIB;
}

pReg->eTxnMon = None;
// determine txn monitor to use; may be either TUXEDO, or blank
size = sizeof(szTmp);
if ( RegQueryValueEx(hKey, "TxnMonitor", 0, &type, (BYTE *)&szTmp, &size) ==
ERROR_SUCCESS )
{
    if ( !strcmp(szTmp, szTxnMonNames[TUXEDO]) )
        pReg->eTxnMon = TUXEDO;
    else if ( !strcmp(szTmp, szTxnMonNames[ENCINA]) )
        pReg->eTxnMon = ENCINA;
    else if ( !strcmp(szTmp, szTxnMonNames[COM]) )
        pReg->eTxnMon = COM;
}

pReg->bCOM_SinglePool = FALSE;
size = sizeof(szTmp);
if ( RegQueryValueEx(hKey, "COM_SinglePool", 0, &type, (BYTE *)&szTmp, &size)
== ERROR_SUCCESS )
{
    if ( !strcmp(szTmp, "YES") )
        pReg->bCOM_SinglePool = TRUE;
}

pReg->dwMaxConnections = 0;
size = sizeof(dwTmp);
if ( ( RegQueryValueEx(hKey, "MaxConnections", 0, &type, (LPBYTE)&dwTmp, &size)
== ERROR_SUCCESS )
    && (type == REG_DWORD) )
    pReg->dwMaxConnections = dwTmp;

pReg->dwMaxPendingDeliveries = 0;
size = sizeof(dwTmp);
if ( ( RegQueryValueEx(hKey, "MaxPendingDeliveries", 0, &type, (LPBYTE)&dwTmp,
&size) == ERROR_SUCCESS )
    && (type == REG_DWORD) )
    pReg->dwMaxPendingDeliveries = dwTmp;

pReg->dwNumberOfDeliveryThreads = 0;
size = sizeof(dwTmp);
if ( ( RegQueryValueEx(hKey, "NumberOfDeliveryThreads", 0, &type,
(LPBYTE)&dwTmp, &size) == ERROR_SUCCESS )
    && (type == REG_DWORD) )
    pReg->dwNumberOfDeliveryThreads = dwTmp;

size = sizeof( pReg->szPath );
```

```
if ( RegQueryValueEx(hKey, "Path", 0, &type, (BYTE *)&pReg->szPath, &size) !=
ERROR_SUCCESS )
    pReg->szPath[0] = 0;

size = sizeof( pReg->szDbServer );
if ( RegQueryValueEx(hKey, "DbServer", 0, &type, (BYTE *)&pReg->szDbServer,
&size) != ERROR_SUCCESS )
    pReg->szDbServer[0] = 0;

size = sizeof( pReg->szDbName );
if ( RegQueryValueEx(hKey, "DbName", 0, &type, (BYTE *)&pReg->szDbName, &size)
!= ERROR_SUCCESS )
    pReg->szDbName[0] = 0;

size = sizeof( pReg->szDbUser );
if ( RegQueryValueEx(hKey, "DbUser", 0, &type, (BYTE *)&pReg->szDbUser, &size)
!= ERROR_SUCCESS )
    pReg->szDbUser[0] = 0;

size = sizeof( pReg->szDbPassword );
if ( RegQueryValueEx(hKey, "DbPassword", 0, &type, (BYTE *)&pReg->szDbPassword,
&size) != ERROR_SUCCESS )
    pReg->szDbPassword[0] = 0;

RegCloseKey(hKey);

return FALSE;
}
```

common/src/ReadRegistry.h

```
/* FILE: ReadRegistry.h
 * Microsoft TPC-C Kit Ver. 4.20.000
 * Copyright Microsoft, 1999
 * All Rights Reserved
 * not audited
 * PURPOSE: Header for registry related code.
 * Change history:
 * 4.20.000 - first version
 */
```

```
enum DBPROTOCOL { Unspecified, ODBC, DBLIB };
const char *szDBNames[] = { "Unspecified", "ODBC", "DBLIB" };

enum TXNMON { None, TUXEDO, ENCINA, COM };
const char *szTxnMonNames[] = { "NONE", "TUXEDO", "ENCINA", "COM" };
```

//This structure defines the data necessary to keep distinct for each terminal or client connection.

```
typedef struct _TPCCREGISTRYDATA
{
    enum DBPROTOCOL eDB_Protocol;
    enum TXNMON eTxnMon;
    BOOL bCOM_SinglePool;
    DWORD dwMaxConnections;
    DWORD dwMaxPendingDeliveries;
```

Appendix A - Application Source Code

```
    DWORD dwNumberOfDeliveryThreads;
    char szPath[128];
    char szDbServer[32];
    char szDbName[32];
    char szDbUser[32];
    char szDbPassword[32];
} TPCCREGISTRYDATA, *PTPCCREGISTRYDATA;

BOOL ReadTPCCRegistrySettings( TPCCREGISTRYDATA *pReg );
```

common/src/error.h

```
/*      FILE:          ERROR.H
 *
 *      Microsoft TPC-C Kit Ver. 4.20.000
 *      Copyright Microsoft, 1999
 *
 *      All Rights Reserved
 *
 *      Version 4.10.000 audited by Richard Gimarc,
 *      Performance Metrics, 3/17/99
 *
 *      PURPOSE: Header file for error exception classes.
 *
 *      Change history:
 *      4.20.000 - updated rev number to match kit
 *      4.21.000 - fixed bug: ~CBaseErr needed to be declared virtual
 */

#pragma once

#ifndef _INC_STRING
#include <string.h>
#endif

const int m_szMsg_size = 512;
const int m_szApp_size = 64;
const int m_szLoc_size = 64;

//error message structure used in ErrorText routines
typedef struct _SERRORMSG
{
    int          iError;                //error id of
    message      char      szMsg[256];  //message to sent to browser
} SERRORMSG;

#define ERR_FATAL_LEVEL          1
#define ERR_WARNING_LEVEL      2
#define ERR_INFORMATION_LEVEL3

#define ERR_TYPE_LOGIC          -1      //logic error in program; internal error
#define ERR_SUCCESS              0      //success (a non-error error)
#define ERR_BAD_ITEM_ID         1      //expected abort record in txnRecord
#define ERR_TYPE_DELIVERY_POST  2      //expected delivery post failed
```

```
#define ERR_TYPE_WEBDLL         3      //tpcc web generated error
#define ERR_TYPE_SQL            4      //sql server generated error
#define ERR_TYPE_DBLIB          5      //dblib generated error
#define ERR_TYPE_ODBC           6      //odbc generated error
#define ERR_TYPE_SOCKET         7      //error on communication socket client rte only
#define ERR_TYPE_DEADLOCK      8      //dblib and odbc only deadlock condition
#define ERR_TYPE_COM           9      //error from COM call
#define ERR_TYPE_TUXEDO        10     //tuxedo error
#define ERR_TYPE_OS            11     //operating system error
#define ERR_TYPE_MEMORY        12     //memory allocation error
#define ERR_TYPE_TPCC_ODBC    13     //error from tpcc odbc txn module
#define ERR_TYPE_TPCC_DBLIB   14     //error from tpcc dblib txn module
#define ERR_TYPE_DELISRV     15     //delivery server error
#define ERR_TYPE_TXNLOG      16     //txn log error
#define ERR_TYPE_BCCONN     17     //Benchcraft connection class
#define ERR_TYPE_TPCC_CONN  18     //Benchcraft connection class
#define ERR_TYPE_ENCINA     19     //Encina error
#define ERR_TYPE_COMPONENT  20     //error from COM component
#define ERR_TYPE_RTE        21     //Benchcraft rte
#define ERR_TYPE_AUTOMATION  22     //Benchcraft automation errors

class CBaseErr
{
public:
    char      *m_szApp;
    char      *m_szMsg;
    char      *m_szLoc; // code location where the error occurred
    int       m_idMsg;

    CBaseErr(void)
    {
        m_idMsg          = 0;
        m_szMsg          = new char[m_szMsg_size];
        m_szApp          = new char[m_szApp_size];
        m_szLoc          = NULL;

        m_szMsg[0]       = 0;
        m_szApp[0]       = 0;

        GetModuleFileName(GetModuleHandle(NULL), m_szApp, m_szApp_size);
    }
};
```

Appendix A - Application Source Code

```
virtual ~CBaseErr(void)
{
    if (m_szMsg)
        delete [] m_szMsg;
    if (m_szApp)
        delete [] m_szApp;
    if (m_szLoc)
        delete [] m_szLoc;
};

CBaseErr(int idMsg)
{
    m_idMsg          = idMsg;
    m_szApp          = new char[m_szApp_size];
    m_szMsg          = new char[m_szMsg_size];
    m_szLoc          = NULL;

    GetModuleFileName(GetModuleHandle(NULL), m_szApp, m_szApp_size);
    LoadString(GetModuleHandle(NULL), idMsg, m_szMsg, m_szMsg_size);
}

CBaseErr(LPCTSTR szMsg)
{
    m_idMsg          = 0;
    m_szApp          = new char[m_szApp_size];
    m_szMsg          = new char[m_szMsg_size];
    m_szLoc          = NULL;

    GetModuleFileName(GetModuleHandle(NULL), m_szApp, m_szApp_size);
    strcpy(m_szMsg, szMsg);
}

void SetError(char *szMsg, LPCTSTR szLocation)
{
    if (szMsg != NULL)
        strcpy(m_szMsg, szMsg);
    else
        m_szMsg[0] = 0;

    if (szLocation != NULL)
    {
        delete [] m_szLoc;
        m_szLoc = new char[strlen(szLocation)+1];
        strcpy(m_szLoc, szLocation);
    }
    else
    {
        delete [] m_szLoc;
        m_szLoc = NULL;
    }
}

virtual void Draw(HWND hwnd, LPCTSTR szStr = NULL)
{
    int      j;
    char    szTmp[512];

    if (szStr)
        j = wsprintf(szTmp, "%s\n", szStr);
    if (m_szLoc)
        j += wsprintf(szTmp+j, "Location=%s\n", m_szLoc);
    if (m_szMsg)
        j += wsprintf(szTmp+j, "%s\n", m_szMsg);
};
```

```
        ::MessageBox(hwnd, szTmp, m_szApp, MB_OK);
    }

    char *GetApp(void) { return m_szApp; }
    char *GetMsg(void) { return m_szMsg; }
    char *GetLocation(void) { return m_szLoc; }

    virtual int ErrorType() = 0; // a value which distinguishes the kind of error
    that occurred
    virtual int ErrorNum() = 0; // an error value specific to the error
    type
    virtual char *ErrorText() = 0; // a string (i.e., human readable)
    representation of the error
};

class CSocketErr : public CBaseErr
{
public:
    enum Action
    {
        eNone,
        eSend,
        eSocket,
        eConnect
    };

    CSocketErr(Action eAction, LPCTSTR szLocation);
    CSocketErr(int iError) { m_errId = iError; };
    int      m_errId;
    Action   m_eAction;

    int ErrorType() { return ERR_TYPE_SOCKET; };
    int ErrorNum() { return m_errId; };
    char *ErrorText(void);
};

class CSystemErr : public CBaseErr
{
public:
    enum Action
    {
        eNone,
        eTransactNamedPipe,
        eWaitNamedPipe,
        eSetNamedPipeHandleState,
        eCreateFile,
        eCreateProcess,
        eCallNamedPipe,
        eCreateEvent,
        eCreateThread,
        eVirtualAlloc,
        eReadFile,
        eWriteFile,
        eMapViewOfFile,
        eCreateFileMapping,
        eInitializeSecurityDescriptor,
        eSetSecurityDescriptorDacl,
        eCreateNamedPipe,
        eConnectNamedPipe,
        eWaitForSingleObject,
        eRegOpenKeyEx,
    };
};
```

Appendix A - Application Source Code

```
        eRegQueryValueEx,
    };

    CSystemErr(Action eAction, LPCTSTR szLocation);

    void Draw(HWND hwnd, LPCTSTR szStr = NULL);

    int         m_errId;
    Action     m_eAction;

    int ErrorType() { return ERR_TYPE_OS;}
    int ErrorNum() { return m_errId;}
    char *ErrorText() { return m_szMsg; }
};

class CMemoryErr : public CBaseErr
{
public:
    CMemoryErr(void);

    int ErrorType() { return ERR_TYPE_MEMORY;}
    int ErrorNum() { return 0;}
    char *ErrorText() { return "Insufficient Memory to continue.";}
};
```

common/src/trans.h

```
/*      FILE:          TRANS.H
 *
 *      Microsoft TPC-C Kit Ver. 4.20.000
 *      Copyright Microsoft, 1999
 *
 *      All Rights Reserved
 *
 *      Version 4.10.000 audited by Richard Gimarc,
 *      Performance Metrics, 3/17/99
 *
 *      PURPOSE: Header file for TPC-C structure templates.
 *
 *      Change history:
 *      *      4.20.000 - updated rev number to match kit
 */
#pragma once

// String length constants
#define SERVER_NAME_LEN      20
#define DATABASE_NAME_LEN   20
#define USER_NAME_LEN       20
#define PASSWORD_LEN        20
#define TABLE_NAME_LEN    20
#define I_DATA_LEN          50
#define I_NAME_LEN          24
#define BRAND_LEN           1
#define LAST_NAME_LEN       16
#define W_NAME_LEN          10
#define ADDRESS_LEN         20
#define STATE_LEN           2
#define ZIP_LEN             9
#define S_DIST_LEN         24
#define S_DATA_LEN         50
```

```
#define D_NAME_LEN          10
#define FIRST_NAME_LEN     16
#define MIDDLE_NAME_LEN    2
#define PHONE_LEN          16
#define DATETIME_LEN       30
#define CREDIT_LEN         2
#define C_DATA_LEN         250
#define H_DATA_LEN         24
#define DIST_INFO_LEN      24
#define MAX_OL_NEW_ORDER_ITEMS 15
#define MAX_OL_ORDER_STATUS_ITEMS 15
#define STATUS_LEN         25
#define OL_DIST_INFO_LEN   24

// TIMESTAMP_STRUCT is provided by the ODBC header file sqltypes.h, but is not available
// when compiling with dblink, so redefined here. Note: we are using the symbol
// "__SQLTYPES"
// (declared in sqltypes.h) as a way to determine if TIMESTAMP_STRUCT has been declared.
#ifdef __SQLTYPES
    typedef struct
    {
        short                /* SQLSMALLINT */ year;
        unsigned short      /* SQLUSMALLINT */ month;
        unsigned short      /* SQLUSMALLINT */ day;
        unsigned short      /* SQLUSMALLINT */ hour;
        unsigned short      /* SQLUSMALLINT */ minute;
        unsigned short      /* SQLUSMALLINT */ second;
        unsigned long       /* SQLINTEGER */ fraction;
    } TIMESTAMP_STRUCT;
#endif

// possible values for exec_status_code after transaction completes
enum EXEC_STATUS
{
    eOK,                // 0    "Transaction committed."
    eInvalidItem,      // 1    "Item number is not valid."
    eDeliveryFailed    // 2    "Delivery Post Failed."
};

// transaction structures
typedef struct
{
    // input params
    short                ol_supply_w_id;
    long                 ol_i_id;
    short                ol_quantity;

    // output params
    char                 ol_i_name[I_NAME_LEN+1];
    char                 ol_brand_generic[BRAND_LEN+1];
    double               ol_i_price;
    double               ol_amount;
    short                ol_stock;
} OL_NEW_ORDER_DATA;

typedef struct
{
    // input params
    short                w_id;
    short                d_id;
    long                 c_id;
    short                o_ol_cnt;
```

Appendix A - Application Source Code

```
// output params
EXEC_STATUS          exec_status_code;
char                 c_last[LAST_NAME_LEN+1];
char                 c_credit[CREDIT_LEN+1];
double               c_discount;
double               w_tax;
double               d_tax;
long                 o_id;
short                o_commit_flag;
TIMESTAMP_STRUCT    o_entry_d;
short                o_all_local;
double               total_amount;
OL_NEW_ORDER_DATA   OL[MAX_OL_NEW_ORDER_ITEMS];
} NEW_ORDER_DATA, *PNEW_ORDER_DATA;

typedef struct
{
    // input params
    short                w_id;
    short                d_id;
    long                 c_id;
    short                c_d_id;
    short                c_w_id;
    double               h_amount;
    char                 c_last[LAST_NAME_LEN+1];

    // output params
    EXEC_STATUS          exec_status_code;
    TIMESTAMP_STRUCT    h_date;
    char                 w_street_1[ADDRESS_LEN+1];
    char                 w_street_2[ADDRESS_LEN+1];
    char                 w_city[ADDRESS_LEN+1];
    char                 w_state[STATE_LEN+1];
    char                 w_zip[ZIP_LEN+1];
    char                 d_street_1[ADDRESS_LEN+1];
    char                 d_street_2[ADDRESS_LEN+1];
    char                 d_city[ADDRESS_LEN+1];
    char                 d_state[STATE_LEN+1];
    char                 d_zip[ZIP_LEN+1];
    char                 c_first[FIRST_NAME_LEN+1];
    char                 c_middle[MIDDLE_NAME_LEN + 1];
    char                 c_street_1[ADDRESS_LEN+1];
    char                 c_street_2[ADDRESS_LEN+1];
    char                 c_city[ADDRESS_LEN+1];
    char                 c_state[STATE_LEN+1];
    char                 c_zip[ZIP_LEN+1];
    char                 c_phone[PHONE_LEN+1];
    TIMESTAMP_STRUCT    c_since;
    char                 c_credit[CREDIT_LEN+1];
    double               c_credit_lim;
    double               c_discount;
    double               c_balance;
    char                 c_data[200+1];
} PAYMENT_DATA, *PPAYMENT_DATA;

typedef struct
{
    long                 ol_i_id;
    short                ol_supply_w_id;
    short                ol_quantity;
    double               ol_amount;
    TIMESTAMP_STRUCT    ol_delivery_d;
} OL_ORDER_STATUS_DATA;
```

```
typedef struct
{
    // input params
    short                w_id;
    short                d_id;
    long                 c_id;
    char                 c_last[LAST_NAME_LEN+1];

    // output params
    EXEC_STATUS          exec_status_code;
    char                 c_first[FIRST_NAME_LEN+1];
    char                 c_middle[MIDDLE_NAME_LEN+1];
    double               c_balance;
    long                 o_id;
    TIMESTAMP_STRUCT    o_entry_d;
    short                o_carrier_id;
    OL_ORDER_STATUS_DATA OL[MAX_OL_ORDER_STATUS_ITEMS];
    short                o_ol_cnt;
} ORDER_STATUS_DATA, *PORDER_STATUS_DATA;
```

```
typedef struct
{
    // input params
    short                w_id;
    short                o_carrier_id;

    // output params
    EXEC_STATUS          exec_status_code;
    SYSTEMTIME           queue_time;
    long                 o_id[10]; // id's of
} DELIVERED_ORDERS_DATA, *PDELIVERED_ORDERS_DATA;

//This structure is used for posting delivery transactions and for writing them to the
//delivery server.
typedef struct _DELIVERY_TRANSACTION
{
    SYSTEMTIME           queue; //time delivery transaction
    short                w_id; //delivery warehouse
    short                o_carrier_id; //carrier id
} DELIVERY_TRANSACTION;

typedef struct
{
    // input params
    short                w_id;
    short                d_id;
    short                threshold;

    // output params
    EXEC_STATUS          exec_status_code;
    long                 low_stock;
} STOCK_LEVEL_DATA, *PSTOCK_LEVEL_DATA;
```

common/src/txn_base.h

```
/* FILE: TXN_BASE.H
 * Microsoft TPC-C Kit Ver. 4.20.000
 * Copyright Microsoft, 1999
 * All Rights Reserved
```

Appendix A - Application Source Code

```
*
*                               Version 4.10.000 audited by Richard Gimarc,
Performance Metrics, 3/17/99
*
*   PURPOSE: Header file for TPC-C txn class implementation.
*
*   Change history:
*       4.20.000 - updated rev number to match kit
*/

#pragma once

// need to declare functions for import, unless define has already been created
// by the DLL's .cpp module for export.
#ifndef DllDecl
#define DllDecl __declspec( dllimport )
#endif

class DllDecl CTPCC_BASE
{
public:
    CTPCC_BASE(void) {};
    virtual ~CTPCC_BASE(void) {};

    virtual PNEW_ORDER_DATA      BuffAddr_NewOrder()
    = 0;
    virtual PPAYMENT_DATA       BuffAddr_Payment()
    = 0;
    virtual PDELIVERY_DATA      BuffAddr_Delivery()
    = 0;
    virtual PSTOCK_LEVEL_DATA    BuffAddr_StockLevel()      = 0;
    virtual PORDER_STATUS_DATA  BuffAddr_OrderStatus()     = 0;

    virtual void NewOrder      () = 0;
    virtual void Payment       () = 0;
    virtual void Delivery      () = 0;
    virtual void StockLevel    () = 0;
    virtual void OrderStatus   () = 0;
};
```

db_dblib_dll/src/tpcc_dblib.cpp

```
/*      FILE:          TPCC_DBLIB.CPP
*
*      Microsoft TPC-C Kit Ver. 4.20.000
*      Copyright Microsoft, 1999
*
*      All Rights Reserved
*
*      Version 4.10.000 audited by Richard Gimarc,
Performance Metrics, 3/17/99
*
*      PURPOSE: Implements dblib calls for TPC-C txns.
*      Contact: Charles Levine (clevine@microsoft.com)
*
*      Change history:
*       4.20.000 - updated rev number to match kit
*       4.10.001 - not deleting error class in catch handler on deadlock
retry;
*
*                               not a functional bug, but a memory leak
```

```
*                               - had to tweak some declarations to compile with
latest SDK; no functional change
*/

#include <windows.h>
#include <stdio.h>
#include <assert.h>

#define DBNTWIN32
#include <sqlfront.h>
#include <sqlldb.h>

#ifdef ICECAP
#include <icapexp.h>
#endif

// need to declare functions for export
#define DllDecl __declspec( dllexport )

#include "..\..\common\src\error.h"
#include "..\..\common\src\trans.h"
#include "..\..\common\src\txn_base.h"
#include "tpcc_dblib.h"

#define DEFCLPACKSIZE          4096

// version string; must match return value from tpcc_version stored proc
const char      sVersion[] = "4.10.000";

const          iMaxRetries = 10;          // how many retries on
deadlock
static long     iConnectionCount = 0;    // number of current dblib connections

BOOL WINAPI DllMain(HMODULE hModule, DWORD ul_reason_for_call, LPVOID lpReserved)
{
    switch( ul_reason_for_call )
    {
        case DLL_PROCESS_ATTACH:
            DisableThreadLibraryCalls(hModule);
            dbinit();          // initialize dblib
            break;

        case DLL_PROCESS_DETACH:
            dbexit();          // close all dblib
            structures/connections
            break;

        default:
            /* nothing */;
    }
    return TRUE;
}

int err_handler(DBPROCESS *dbproc, int severity, int dberr, int oserr, LPCSTR dberrstr,
LPCSTR oserrstr)
{
    CTPCC_DBLIB          *pConn;

    assert(dbproc != NULL);
    pConn = (CTPCC_DBLIB*)dbgetuserdata(dbproc);

    if (pConn != NULL)
```

Appendix A - Application Source Code

```
{
    pConn->SetDbLibError( severity, dberr, oserr, dberrstr, oserrstr );
}
return INT_CANCEL;
}

/* FUNCTION: int msg_handler(DBPROCESS *dbproc, DBINT msgno, int msgstate, int severity,
char *msgtext)
*
* PURPOSE:      This function handles DB-Library SQL Server error messages
*
* ARGUMENTS:    DBPROCESS      *dbproc          DBPROCESS id
pointer
*              DBINT          msgno
*              int            msgstate
*              int            severity
*              char          *msgtext
*              printable message description
*
* RETURNS:      int
                continue if error is SQLETIME else INT_CANCEL action
*
* INT_CANCEL   cancel operation
*
* COMMENTS:    This function also sets the dead lock dbproc variable if necessary.
*/

// typedef INT (SQLAPI *DBMSGHANDLE_PROC)(PDBPROCESS, DBINT, INT, INT, LPCSTR, LPCSTR,
LPCSTR, DBUSMALLINT);

int msg_handler(DBPROCESS *dbproc, DBINT msgno, int msgstate, int severity,
                LPCSTR msgtext, LPCSTR srvname, LPCSTR procname,
DBUSMALLINT line)
{
    CTPCC_DBLIB      *pConn;

    assert(dbproc != NULL);
    pConn = (CTPCC_DBLIB*)dbgetuserdata(dbproc);

    if (pConn != NULL)
    {
        pConn->SetSqlError( msgno, msgstate, severity, msgtext );
    }

    return 0;
}

/* FUNCTION: void UtilStrCpy(char * pDest, char * pSrc, int n)
*
* PURPOSE:      This function copies n characters from string pSrc to pDst and places
a
*              null character at the end of the destination string.
*
* ARGUMENTS:    char          *pDest  destination string pointer
*              char          *pSrc   source
string pointer
*              int          n
*              number of characters to copy
*
```

```
* RETURNS:      None
*
* COMMENTS:    Unlike strncpy this function ensures that the result string is
*              always null terminated.
*/

inline static void UtilStrCpy(char * pDest, const BYTE * pSrc, int n)
{
    strncpy(pDest, (char *)pSrc, n);
    pDest[n] = '\0';

    return;
}

/* FUNCTION: CTPCC_DBLIB_ERR::ErrorText
*
*/

char* CTPCC_DBLIB_ERR::ErrorText(void)
{
    int i;

    static SERRORMSG errorMsgs[] =
    {
        { ERR_WRONG_SP_VERSION,          "Wrong version of stored
procs on database server" },
        { ERR_INVALID_CUST,              "Invalid Customer id,name." },
        { ERR_NO_SUCH_ORDER,             "No orders found for
customer." },
        { 0,                              "" }
    };

    static char szNotFound[] = "Unknown error number.";

    for(i=0; errorMsgs[i].szMsg[0]; i++)
    {
        if ( m_errno == errorMsgs[i].iError )
            break;
    }

    if ( !errorMsgs[i].szMsg[0] )
        return szNotFound;

    else
        return errorMsgs[i].szMsg;
}

// wrapper routine for class constructor
__declspec(dllexport) CTPCC_DBLIB* CTPCC_DBLIB_new(
    LPCSTR szServer,          // name of SQL server
    LPCSTR szUser,           // user name for login
    LPCSTR szPassword,       // password for login
    LPCSTR szHost,          // workstation name; shows up in
sp_who; max 30 chars, only first 10 kept by SQL Server
    LPCSTR szDatabase )     // name of database to use
{
    return new CTPCC_DBLIB( szServer, szUser, szPassword, szHost, szDatabase );
}

CTPCC_DBLIB::CTPCC_DBLIB (
```

Appendix A - Application Source Code

```
LPCSTR szServer,          // name of SQL server
LPCSTR szUser,           // user name for login
LPCSTR szPassword,      // password for login
LPCSTR szHost,          // workstation name; shows up in
sp_who; max 30 chars, only first 10 kept by SQL Server
LPCSTR szDatabase )     // name of database to use
{
    LOGINREC *login;
    const BYTE *pData;

    // initialization
    m_dbproc = NULL;
    m_DbLibErr = (CDBLIBERR*)NULL;
    m_SqlErr = (CSQLERR*)NULL;

    m_MaxRetries = 10;          // how many retries on deadlock

    // increase max number of connections if getting close
    if ( dbgetmaxprocs() < (iConnectionCount+5) )
    {
        if ( dbsetmaxprocs(iConnectionCount+10) == FAIL )
            ThrowError(CDBLIBERR::eDbSetMaxProcs);
    }

    // allocate a login structure
    login = dblogin();
    if (login == NULL)
        ThrowError(CDBLIBERR::eLogin);
    InterlockedIncrement( &iConnectionCount );

    // register error and message handler functions
    if (dbprocerrhandle(login, err_handler) == NULL)
        ThrowError(CDBLIBERR::eDbProcHandler);

    if (dbprocmsghandle(login, msg_handler) == NULL)
        ThrowError(CDBLIBERR::eDbProcHandler);

    DBSETLUSER(login, szUser);
    DBSETLPWD(login, szPassword);
    DBSETHOST(login, szHost);
    DBSETLPACKET(login, (unsigned short)DEFCLPACKSIZE);
    DBSETLVERSION(login, DBVER60);          // use dlib ver 6.0 client
behavior

    // set time to wait for login
    if (dbsetlogintime(60) == FAIL)
        ThrowError(CDBLIBERR::eDbSet);

    // set time to wait for statement execution
    if (dbsettime(180) == FAIL)
        ThrowError(CDBLIBERR::eDbSet);

    m_dbproc = dbopen(login, szServer);

    // deallocate login structure before checking for success
    dbfreelogin( login );

    if (m_dbproc == NULL)
        ThrowError(CDBLIBERR::eDbOpen);

    // save address of class instance so that the message and error handler
    // can get to data.
```

```
dbsetuserdata(m_dbproc, (LPVOID)this);

    // Use the the right database
    if (dbuse(m_dbproc, szDatabase) == FAIL)
        ThrowError(CDBLIBERR::eDbUse);

    dbcmd(m_dbproc, "set nocount on ");          // do not return
row counts
    dbcmd(m_dbproc, "set XACT_ABORT ON");          // rollback transaction on
abort

    if (dbsqlexec(m_dbproc) == FAIL)
        ThrowError(CDBLIBERR::eDbSqlExec);

    DiscardNextResults(2);

    // verify that version of stored procs on server is correct
    dbrpcinit(m_dbproc, "tpcc_version", 0);

    if (dbrpcexec(m_dbproc) == FAIL)
        ThrowError(CDBLIBERR::eDbRpcExec);

    if (dbresults(m_dbproc) != SUCCEED)
        ThrowError(CDBLIBERR::eDbResults);

    if (dbnextrow(m_dbproc) != REG_ROW)
        ThrowError(CDBLIBERR::eDbNextRow);

    char szSrvVersion[16];
    pData=dbdata(m_dbproc, 1);
    if (pData)
        UtilStrCpy(szSrvVersion, pData, dbdatlen(m_dbproc, 1));
    else
        szSrvVersion[0]=0;
    if (strcmp(szSrvVersion,sVersion))
        throw new CTPCC_DBLIB_ERR( CTPCC_DBLIB_ERR::ERR_WRONG_SP_VERSION );

    DiscardNextRows(0);
    DiscardNextResults(0);
}

CTPCC_DBLIB::~~CTPCC_DBLIB( void )
{
    // close db connection and deallocate resources
    dbclose(m_dbproc);
    InterlockedDecrement( &iConnectionCount );
    if (m_DbLibErr != NULL)
        delete m_DbLibErr;
    if (m_SqlErr != NULL)
        delete m_SqlErr;
}

void CTPCC_DBLIB::SetDbLibError(int severity, int dberr, int oserr, LPCSTR dberrstr,
LPCSTR oserrstr)
{
    delete m_DbLibErr;
    m_DbLibErr = new CDBLIBERR(CDBLIBERR::eUnknown, severity, dberr, oserr);

    if (dberrstr != NULL)
    {
        m_DbLibErr->m_dberrstr = new char[ strlen(dberrstr)+1 ];
```

Appendix A - Application Source Code

```
        strcpy( m_DbLibErr->m_dberrstr, dberrstr );
    }
    if (oserrstr != NULL)
    {
        m_DbLibErr->m_oserrstr = new char[ strlen(oserrstr)+1 ];
        strcpy( m_DbLibErr->m_oserrstr, oserrstr );
    }
}

void CTPCC_DBLIB::SetSqlError( int /*DBINT*/ msgno, int msgstate, int severity, LPCSTR
msgtext )
{
    if (m_SqlErr == NULL)
        m_SqlErr = new CSQLErr();

    m_SqlErr->m_msgno = msgno;
    m_SqlErr->m_msgstate = msgstate;
    m_SqlErr->m_severity = severity;

    delete [] m_SqlErr->m_msgtext;
    if (msgtext != NULL)
    {
        m_SqlErr->m_msgtext = new char[ strlen(msgtext)+1 ];
        strcpy( m_SqlErr->m_msgtext, msgtext );
    }
}

void CTPCC_DBLIB::ThrowError( CDBLIBERR::ACTION eAction )
{
    // discard anything still in return buffer
    DiscardNextRows(-1);
    DiscardNextResults(-1);

    // check for SQL Server error first; if yes, throw it and ignore any DBLib
error.
    if (m_SqlErr != NULL)
    {
        CSQLErr *pSqlErr;
        pSqlErr = m_SqlErr;
        m_SqlErr = NULL; // clear our pointer to instance; catch handler
will delete
        throw pSqlErr;
    }

    CDBLIBERR *pDbLibErr;
    if (m_DbLibErr == NULL)
        // this case isn't expected to happen, since it means that an error
was returned
        // but the error handlers were not called.
        pDbLibErr = new CDBLIBERR(eAction);
    else
    {
        pDbLibErr = m_DbLibErr;
        pDbLibErr->m_eAction = eAction;
        m_DbLibErr = NULL; // clear our pointer to instance; catch
handler will delete
    }
    throw pDbLibErr;
}
}
```

```
// Read and discard rows until no more. Throw an exception if number of rows read
doesn't
// match number of rows expected. The row count will be ignored if the expected count
value
// passed in is negative. A typical use of this routine is to verify that there are no
more
// rows to be read.
void CTPCC_DBLIB::DiscardNextRows(int iExpectedCount)
{
    int iRowsRead = 0;
    RETCODE rc;

    while (TRUE)
    {
        rc = dbnextrow(m_dbproc);
        if (rc == NO_MORE_ROWS)
            break;
        if (rc == FAIL)
        {
            if (iExpectedCount >= 0)
                ThrowError(CDBLIBERR::eDbNextRow);
            else
                break;
        }
        iRowsRead++;
    }

    if ((iExpectedCount >= 0) &&
        (iExpectedCount != iRowsRead))
        ThrowError(CDBLIBERR::eWrongRowCount);
}

// Read and discard results until no more. Throw an exception if number of result sets
read doesn't
// match number expected. The result set count will be ignored if the expected count
value
// passed in is negative. A typical use of this routine is to verify that there are no
more
// result sets to be read.
void CTPCC_DBLIB::DiscardNextResults(int iExpectedCount)
{
    int iResultsRead = 0;
    RETCODE rc;

    while (TRUE)
    {
        rc = dbresults(m_dbproc);
        if (rc == NO_MORE_RESULTS)
            break;
        if (rc == FAIL)
        {
            if (iExpectedCount >= 0)
                ThrowError(CDBLIBERR::eDbResults);
            else
                break;
        }

        DiscardNextRows(-1);
        iResultsRead++;
    }

    if ((iExpectedCount >= 0) &&
        (iExpectedCount != iResultsRead))
}
```

Appendix A - Application Source Code

```
        ThrowError(CDBLIBERR::eWrongRowCount);
    }
}

void CTPCC_DBLIB::StockLevel()
{
    int          iTryCount = 0;
    const BYTE   *pData;

    ResetError();

    while (TRUE)
    {
        try
        {
            dbrpcinit(m_dbproc, "tpcc_stocklevel", 0);

            dbrpcparam(m_dbproc, NULL, 0, SQLINT2, -1, -1, (BYTE *)
&m_txn.StockLevel.w_id); // @w_id smallint
            dbrpcparam(m_dbproc, NULL, 0, SQLINT1, -1, -1, (BYTE *)
&m_txn.StockLevel.d_id); // @d_id tinyint
            dbrpcparam(m_dbproc, NULL, 0, SQLINT2, -1, -1, (BYTE *)
&m_txn.StockLevel.threshold); // @threshold smallint

            if (dbrpcexec(m_dbproc) == FAIL)
                ThrowError(CDBLIBERR::eDbRpcExec);

            if (dbresults(m_dbproc) != SUCCEED)
                ThrowError(CDBLIBERR::eDbResults);

            if (dbnextrow(m_dbproc) != REG_ROW)
                ThrowError(CDBLIBERR::eDbNextRow);

            if (pData=dbdata(m_dbproc, 1))
                m_txn.StockLevel.low_stock = *((long *) pData);

            DiscardNextRows(0);
            DiscardNextResults(0);

            m_txn.StockLevel.exec_status_code = eOK;
            return;
        }
        catch (CSQLERR *e)
        {
            if ((e->m_msgno != 1205) || (++iTryCount > iMaxRetries))
                throw;

            // hit deadlock; backoff for increasingly longer period
            delete e;
            Sleep(10 * iTryCount);
        }
    } // while (TRUE)
}

void CTPCC_DBLIB::NewOrder()
{
    int          i;
    DBINT        commit_flag;
    DBDATETIME   datetime;
    DBDATERECD   daterec;

    int          iTryCount = 0;
    const BYTE   *pData;
```

```
    ResetError();

    while (TRUE)
    {
        try
        {
            dbrpcinit(m_dbproc, "tpcc_neworder", 0);

            dbrpcparam(m_dbproc, NULL, 0, SQLINT2, -1, -1, (BYTE *)
&m_txn.NewOrder.w_id);
            dbrpcparam(m_dbproc, NULL, 0, SQLINT1, -1, -1, (BYTE *)
&m_txn.NewOrder.d_id);
            dbrpcparam(m_dbproc, NULL, 0, SQLINT4, -1, -1, (BYTE *)
&m_txn.NewOrder.c_id);
            dbrpcparam(m_dbproc, NULL, 0, SQLINT1, -1, -1, (BYTE *)
&m_txn.NewOrder.o_ol_cnt);

            // check whether any order lines are for a remote warehouse
            m_txn.NewOrder.o_all_local = 1;
            for (i = 0; i < m_txn.NewOrder.o_ol_cnt; i++)
            {
                if (m_txn.NewOrder.OL[i].ol_supply_w_id !=
                    m_txn.NewOrder.w_id)
                {
                    m_txn.NewOrder.o_all_local = 0; // at
                    least one remote warehouse
                    break;
                }
            }
            dbrpcparam(m_dbproc, NULL, 0, SQLINT1, -1, -1, (BYTE *)
&m_txn.NewOrder.o_all_local);

            for (i = 0; i < m_txn.NewOrder.o_ol_cnt; i++)
            {
                dbrpcparam(m_dbproc, NULL, 0, SQLINT4, -1, -1,
(BYTE *) &m_txn.NewOrder.OL[i].ol_i_id);
                dbrpcparam(m_dbproc, NULL, 0, SQLINT2, -1, -1,
(BYTE *) &m_txn.NewOrder.OL[i].ol_supply_w_id);
                dbrpcparam(m_dbproc, NULL, 0, SQLINT2, -1, -1,
(BYTE *) &m_txn.NewOrder.OL[i].ol_quantity);
            }

            if (dbrpcexec(m_dbproc) == FAIL)
                ThrowError(CDBLIBERR::eDbRpcExec);

            // Get order line results
            m_txn.NewOrder.total_amount = 0;
            for (i = 0; i < m_txn.NewOrder.o_ol_cnt; i++)
            {
                if (dbresults(m_dbproc) != SUCCEED)
                    ThrowError(CDBLIBERR::eDbResults);

                if (dbnumcols(m_dbproc) != 5)
                    ThrowError(CDBLIBERR::eWrongNumCols);

                if (dbnextrow(m_dbproc) != REG_ROW)
                    ThrowError(CDBLIBERR::eDbNextRow);

                if (pData=dbdata(m_dbproc, 1))
                    UtilStrCpy(m_txn.NewOrder.OL[i].ol_i_name, pData, dbdatlen(m_dbproc, 1));
            }
        }
    }
}
```

Appendix A - Application Source Code

```
        if(pData=dbdata(m_dbproc, 2))
            m_txn.NewOrder.OL[i].ol_stock =
(* (DBSMALLINT *) pData);
        if(pData=dbdata(m_dbproc, 3))
            UtilStrCpy(m_txn.NewOrder.OL[i].ol_brand_generic, pData, dbdatlen(m_dbproc,
3));
        if(pData=dbdata(m_dbproc, 4))
            dbconvert(m_dbproc, SQLNUMERIC, pData,
dbdatlen(m_dbproc,4),
SQLFLT8, (BYTE
*)&m_txn.NewOrder.OL[i].ol_i_price, 8);
        if(pData=dbdata(m_dbproc, 5))
            dbconvert(m_dbproc, SQLNUMERIC, pData,
dbdatlen(m_dbproc,5),
SQLFLT8, (BYTE
*)&m_txn.NewOrder.OL[i].ol_amount, 8);
        m_txn.NewOrder.total_amount =
m_txn.NewOrder.total_amount + m_txn.NewOrder.OL[i].ol_amount;
        DiscardNextRows(0);
    }
    // get remaining values for w_tax, d_tax, o_id, c_last,
c_discount, c_credit, o_entry_d, commit_flag
    if (dbresults(m_dbproc) != SUCCEED)
        ThrowError(CDBLIBERR::eDbResults);
    if (dbnextrow(m_dbproc) != REG_ROW)
        ThrowError(CDBLIBERR::eDbNextRow);
    if (dbnumcols(m_dbproc) != 8)
        ThrowError(CDBLIBERR::eWrongNumCols);
    if (pData=dbdata(m_dbproc, 1))
        dbconvert(m_dbproc, SQLNUMERIC, pData,
dbdatlen(m_dbproc,1), SQLFLT8, (BYTE *)&m_txn.NewOrder.w_tax, 8);
    if (pData=dbdata(m_dbproc, 2))
        dbconvert(m_dbproc, SQLNUMERIC, pData,
dbdatlen(m_dbproc,2), SQLFLT8, (BYTE *)&m_txn.NewOrder.d_tax, 8);
    if (pData=dbdata(m_dbproc, 3))
        m_txn.NewOrder.o_id = (*(DBINT *) pData);
    if (pData=dbdata(m_dbproc, 4))
        UtilStrCpy(m_txn.NewOrder.c_last, pData,
dbdatlen(m_dbproc, 4));
    if (pData=dbdata(m_dbproc, 5))
        dbconvert(m_dbproc, SQLNUMERIC, pData,
dbdatlen(m_dbproc,5), SQLFLT8, (BYTE *)&m_txn.NewOrder.c_discount, 8);
    if (pData=dbdata(m_dbproc, 6))
        UtilStrCpy(m_txn.NewOrder.c_credit, pData,
dbdatlen(m_dbproc, 6));
    if (pData=dbdata(m_dbproc, 7))
    {
        datetime = (*(DBDATETIME *) pData);
        dbdatecrack(m_dbproc, &daterec, &datetime);
        m_txn.NewOrder.o_entry_d.year = daterec.year;
        m_txn.NewOrder.o_entry_d.month = daterec.month;
```

```
        m_txn.NewOrder.o_entry_d.day = daterec.day;
        m_txn.NewOrder.o_entry_d.hour = daterec.hour;
        m_txn.NewOrder.o_entry_d.minute = daterec.minute;
        m_txn.NewOrder.o_entry_d.second = daterec.second;
    }
    if (pData=dbdata(m_dbproc, 8))
        commit_flag = (*(DBTINYINT *) pData);
    DiscardNextRows(0);
    DiscardNextResults(0);
    if (commit_flag == 1)
    {
        m_txn.NewOrder.total_amount *= ((1 +
m_txn.NewOrder.w_tax + m_txn.NewOrder.d_tax) * (1 - m_txn.NewOrder.c_discount));
        m_txn.NewOrder.exec_status_code = eOK;
    }
    else
        m_txn.NewOrder.exec_status_code = eInvalidItem;
    return;
}
catch (CSQLERR *e)
{
    if ((e->m_msgno != 1205) || (++iTryCount > iMaxRetries))
        throw;
    // hit deadlock; backoff for increasingly longer period
    delete e;
    Sleep(10 * iTryCount);
}
// while (TRUE)
}

void CTPCC_DBLIB::Payment()
{
    DBDATETIME datetime;
    DBDATEREC daterec;
    int iTryCount = 0;
    const BYTE *pData;
    ResetError();
    while (TRUE)
    {
        try
        {
            dbrpcinit(m_dbproc, "tpcc_payment", 0);
            dbrpcparam(m_dbproc, NULL, 0, SQLINT2, -1, -1, (BYTE *)
&m_txn.Payment.w_id);
            dbrpcparam(m_dbproc, NULL, 0, SQLINT2, -1, -1, (BYTE *)
&m_txn.Payment.c_w_id);
            dbrpcparam(m_dbproc, NULL, 0, SQLFLT8, -1, -1, (BYTE *)
&m_txn.Payment.h_amount);
            dbrpcparam(m_dbproc, NULL, 0, SQLINT1, -1, -1, (BYTE *)
&m_txn.Payment.d_id);
            dbrpcparam(m_dbproc, NULL, 0, SQLINT1, -1, -1, (BYTE *)
&m_txn.Payment.c_d_id);
```

Appendix A - Application Source Code

```
&m_txn.Payment.c_id);
    dbrpcparam(m_dbproc, NULL, 0, SQLINT4, -1, -1, (BYTE *)
// if customer id is zero, then payment is by name
if (m_txn.Payment.c_id == 0)
    dbrpcparam(m_dbproc, NULL, 0, SQLCHAR, -1,
strlen(m_txn.Payment.c_last), (unsigned char *)m_txn.Payment.c_last);

if (dbrpcexec(m_dbproc) == FAIL)
    ThrowError(CDBLIBERR::eDbRpcExec);

if (dbresults(m_dbproc) != SUCCEED)
    ThrowError(CDBLIBERR::eDbResults);

if (dbnextrow(m_dbproc) != REG_ROW)
    ThrowError(CDBLIBERR::eDbNextRow);

if (dbnumcols(m_dbproc) != 27)
    ThrowError(CDBLIBERR::eWrongNumCols);

if (pData=dbdata(m_dbproc, 1))
    m_txn.Payment.c_id = *((DBINT *) pData);
if (pData=dbdata(m_dbproc, 2))
    UtilStrCpy(m_txn.Payment.c_last, pData,
dbdatlen(m_dbproc, 2));

if (pData=dbdata(m_dbproc, 3))
{
    datetime = *((DBDATETIME *) pData);
    dbdatecrack(m_dbproc, &daterec, &datetime);
    m_txn.Payment.h_date.year = daterec.year;
    m_txn.Payment.h_date.month = daterec.month;
    m_txn.Payment.h_date.day = daterec.day;
    m_txn.Payment.h_date.hour = daterec.hour;
    m_txn.Payment.h_date.minute = daterec.minute;
    m_txn.Payment.h_date.second = daterec.second;
}
if (pData=dbdata(m_dbproc, 4))
    UtilStrCpy(m_txn.Payment.w_street_1, pData,
dbdatlen(m_dbproc, 4));
if (pData=dbdata(m_dbproc, 5))
    UtilStrCpy(m_txn.Payment.w_street_2, pData,
dbdatlen(m_dbproc, 5));
if (pData=dbdata(m_dbproc, 6))
    UtilStrCpy(m_txn.Payment.w_city, pData,
dbdatlen(m_dbproc, 6));
if (pData=dbdata(m_dbproc, 7))
    UtilStrCpy(m_txn.Payment.w_state, pData,
dbdatlen(m_dbproc, 7));
if (pData=dbdata(m_dbproc, 8))
    UtilStrCpy(m_txn.Payment.w_zip, pData,
dbdatlen(m_dbproc, 8));
if (pData=dbdata(m_dbproc, 9))
    UtilStrCpy(m_txn.Payment.d_street_1, pData,
dbdatlen(m_dbproc, 9));
if (pData=dbdata(m_dbproc, 10))
    UtilStrCpy(m_txn.Payment.d_street_2, pData,
dbdatlen(m_dbproc, 10));
if (pData=dbdata(m_dbproc, 11))
    UtilStrCpy(m_txn.Payment.d_city, pData,
dbdatlen(m_dbproc, 11));
if (pData=dbdata(m_dbproc, 12))
    UtilStrCpy(m_txn.Payment.d_state, pData,
dbdatlen(m_dbproc, 12));
```

```
dbdatlen(m_dbproc, 13));
if (pData=dbdata(m_dbproc, 13))
    UtilStrCpy(m_txn.Payment.d_zip, pData,
dbdatlen(m_dbproc, 13));
if (pData=dbdata(m_dbproc, 14))
    UtilStrCpy(m_txn.Payment.c_first, pData,
dbdatlen(m_dbproc, 14));
if (pData=dbdata(m_dbproc, 15))
    UtilStrCpy(m_txn.Payment.c_middle, pData,
dbdatlen(m_dbproc, 15));
if (pData=dbdata(m_dbproc, 16))
    UtilStrCpy(m_txn.Payment.c_street_1, pData,
dbdatlen(m_dbproc, 16));
if (pData=dbdata(m_dbproc, 17))
    UtilStrCpy(m_txn.Payment.c_street_2, pData,
dbdatlen(m_dbproc, 17));
if (pData=dbdata(m_dbproc, 18))
    UtilStrCpy(m_txn.Payment.c_city, pData,
dbdatlen(m_dbproc, 18));
if (pData=dbdata(m_dbproc, 19))
    UtilStrCpy(m_txn.Payment.c_state, pData,
dbdatlen(m_dbproc, 19));
if (pData=dbdata(m_dbproc, 20))
    UtilStrCpy(m_txn.Payment.c_zip, pData,
dbdatlen(m_dbproc, 20));
if (pData=dbdata(m_dbproc, 21))
    UtilStrCpy(m_txn.Payment.c_phone, pData,
dbdatlen(m_dbproc, 21));
if (pData=dbdata(m_dbproc, 22))
{
    datetime = *((DBDATETIME *) pData);
    dbdatecrack(m_dbproc, &daterec, &datetime);
    m_txn.Payment.c_since.year = daterec.year;
    m_txn.Payment.c_since.month = daterec.month;
    m_txn.Payment.c_since.day = daterec.day;
    m_txn.Payment.c_since.hour = daterec.hour;
    m_txn.Payment.c_since.minute = daterec.minute;
    m_txn.Payment.c_since.second = daterec.second;
}
if (pData=dbdata(m_dbproc, 23))
    UtilStrCpy(m_txn.Payment.c_credit, pData,
dbdatlen(m_dbproc, 23));
if (pData=dbdata(m_dbproc, 24))
    dbconvert(m_dbproc, SQLNUMERIC, pData,
dbdatlen(m_dbproc, 24), SQLFLT8, (BYTE *)&m_txn.Payment.c_credit_lim, 8);
if (pData=dbdata(m_dbproc, 25))
    dbconvert(m_dbproc, SQLNUMERIC, pData,
dbdatlen(m_dbproc, 25), SQLFLT8, (BYTE *)&m_txn.Payment.c_discount, 8);
if (pData=dbdata(m_dbproc, 26))
    dbconvert(m_dbproc, SQLNUMERIC, pData,
dbdatlen(m_dbproc, 26), SQLFLT8, (BYTE *)&m_txn.Payment.c_balance, 8);
if (pData=dbdata(m_dbproc, 27))
    UtilStrCpy(m_txn.Payment.c_data, pData,
dbdatlen(m_dbproc, 27));

DiscardNextRows(0);
DiscardNextResults(0);

if (m_txn.Payment.c_id == 0)
    throw new CTPCC_DBLIB_ERR(
CTPCC_DBLIB_ERR::ERR_INVALID_CUST );
else
    m_txn.Payment.exec_status_code = eOK;
```

Appendix A - Application Source Code

```
        return;
    }
    catch (CSQLERR *e)
    {
        if ((e->m_msgno != 1205) || (++iTryCount > iMaxRetries))
            throw;

        // hit deadlock; backoff for increasingly longer period
        delete e;
        Sleep(10 * iTryCount);
    }
    // while (TRUE)
}

void CTPCC_DBLIB::OrderStatus()
{
    int i;
    DBDATETIME datetime;
    DBDATERECDaterec;

    int iTryCount = 0;
    RETCODE rc;
    const BYTE *pData;

    ResetError();

    while (TRUE)
    {
        try
        {
            dbrpcinit(m_dbproc, "tpcc_orderstatus", 0);
            dbrpcparam(m_dbproc, NULL, 0, SQLINT2, -1, -1, (BYTE *)
&m_txn.OrderStatus.w_id);
            dbrpcparam(m_dbproc, NULL, 0, SQLINT1, -1, -1, (BYTE *)
&m_txn.OrderStatus.d_id);
            dbrpcparam(m_dbproc, NULL, 0, SQLINT4, -1, -1, (BYTE *)
&m_txn.OrderStatus.c_id);

            // if customer id is zero, then order status is by name
            if (m_txn.OrderStatus.c_id == 0)
                dbrpcparam(m_dbproc, NULL, 0, SQLCHAR, -1,
strlen(m_txn.OrderStatus.c_last), (unsigned char *)m_txn.OrderStatus.c_last);

            if (dbrpcexec(m_dbproc) == FAIL)
                ThrowError(CDBLIBERR::eDbRpcExec);

            // Get order lines
            if (dbresults(m_dbproc) != SUCCEED)
            {
                if ((m_DbLibErr == NULL) && (m_SqlErr == NULL))
                    throw new CTPCC_DBLIB_ERR(
CTPCC_DBLIB_ERR::ERR_NO_SUCH_ORDER );
                else
                    ThrowError(CDBLIBERR::eDbResults);
            }

            if (dbnumcols(m_dbproc) != 5)
                ThrowError(CDBLIBERR::eWrongNumCols);
        }
    }
}
```

```
        i = 0;
        while (TRUE)
        {
            rc = dbnextrow(m_dbproc);
            if (rc == NO_MORE_ROWS)
                break;
            if (rc != REG_ROW)
                ThrowError(CDBLIBERR::eDbNextRow);

            if (pData=dbdata(m_dbproc, 1))
                m_txn.OrderStatus.OL[i].ol_supply_w_id =
                (* (DBSMALLINT *) pData);

            if (pData=dbdata(m_dbproc, 2))
                m_txn.OrderStatus.OL[i].ol_i_id =
                (* (DBSMALLINT *) pData);

            if (pData=dbdata(m_dbproc, 3))
                m_txn.OrderStatus.OL[i].ol_quantity =
            if (pData=dbdata(m_dbproc, 4))
                dbconvert(m_dbproc, SQLNUMERIC, pData,
                SQLFLT8, (BYTE
                *)&m_txn.OrderStatus.OL[i].ol_amount, 8);
            if (pData=dbdata(m_dbproc, 5))
            {
                datetime = *((DBDATETIME *) pData);
                dbdatecrack(m_dbproc, &daterec,
                &datetime);

                m_txn.OrderStatus.OL[i].ol_delivery_d.year = daterec.year;
                m_txn.OrderStatus.OL[i].ol_delivery_d.month = daterec.month;
                m_txn.OrderStatus.OL[i].ol_delivery_d.day = daterec.day;
                m_txn.OrderStatus.OL[i].ol_delivery_d.hour = daterec.hour;
                m_txn.OrderStatus.OL[i].ol_delivery_d.minute = daterec.minute;
                m_txn.OrderStatus.OL[i].ol_delivery_d.second = daterec.second;
            }
            i++;
        }
        m_txn.OrderStatus.o_ol_cnt = i;

        if (dbresults(m_dbproc) != SUCCEED)
            ThrowError(CDBLIBERR::eDbResults);

        if (dbnextrow(m_dbproc) != REG_ROW)
            ThrowError(CDBLIBERR::eDbNextRow);

        if (dbnumcols(m_dbproc) != 8)
            ThrowError(CDBLIBERR::eWrongNumCols);

        if (pData=dbdata(m_dbproc, 1))
            m_txn.OrderStatus.c_id = (* (DBINT *) pData);
        if (pData=dbdata(m_dbproc, 2))
            UtilStrCpy(m_txn.OrderStatus.c_last, pData,
            dbdatlen(m_dbproc, 2));

        if (pData=dbdata(m_dbproc, 3))
```

Appendix A - Application Source Code

```
        UtilStrCpy(m_txn.OrderStatus.c_first, pData,
dbdatlen(m_dbproc,3));
        if(pData=dbdata(m_dbproc, 4))
            UtilStrCpy(m_txn.OrderStatus.c_middle, pData,
dbdatlen(m_dbproc, 4));
        if(pData=dbdata(m_dbproc, 5))
        {
            datetime = *((DBDATETIME *) pData);
            dbdatecrack(m_dbproc, &daterec, &datetime);
            m_txn.OrderStatus.o_entry_d.year =
daterec.year;
            m_txn.OrderStatus.o_entry_d.month =
daterec.month;
            m_txn.OrderStatus.o_entry_d.day = daterec.day;
            m_txn.OrderStatus.o_entry_d.hour =
daterec.hour;
            m_txn.OrderStatus.o_entry_d.minute =
daterec.minute;
            m_txn.OrderStatus.o_entry_d.second =
daterec.second;
        }
        if(pData=dbdata(m_dbproc, 6))
            m_txn.OrderStatus.o_carrier_id = (*(DBSMALLINT *)
pData);
        if(pData=dbdata(m_dbproc, 7))
            dbconvert(m_dbproc, SQLNUMERIC, pData,
dbdatlen(m_dbproc,7),
                SQLFLT8, (BYTE
*)&m_txn.OrderStatus.c_balance, 8);
        if(pData=dbdata(m_dbproc, 8))
            m_txn.OrderStatus.o_id = (*(DBINT *) pData);

        DiscardNextRows(0);
        DiscardNextResults(0);

        if (m_txn.OrderStatus.o_ol_cnt == 0)
            throw new CTPCC_DBLIB_ERR(
CTPCC_DBLIB_ERR::ERR_NO_SUCH_ORDER );
        else if (m_txn.OrderStatus.c_id == 0 &&
m_txn.OrderStatus.c_last[0] == 0)
            throw new CTPCC_DBLIB_ERR(
CTPCC_DBLIB_ERR::ERR_INVALID_CUST );
        else
            m_txn.OrderStatus.exec_status_code = eOK;

        return;
    }
    catch (CSQLERR *e)
    {
        if ((e->m_msgno != 1205) || (++iTryCount > iMaxRetries))
            throw;

        // hit deadlock; backoff for increasingly longer period
        delete e;
        Sleep(10 * iTryCount);
    }
}
// while (TRUE)

void CTPCC_DBLIB::Delivery()
{
```

```
        int
        int
        const BYTE
        *pData;

        ResetError();

        while (TRUE)
        {
            try
            {
                dbrpcinit(m_dbproc, "tpcc_delivery", 0);
                dbrpcparam(m_dbproc, NULL, 0, SQLINT2, -1, -1, (BYTE *)
&m_txn.Delivery.w_id);
                dbrpcparam(m_dbproc, NULL, 0, SQLINT1, -1, -1, (BYTE *)
&m_txn.Delivery.o_carrier_id);

                if (dbrpcexec(m_dbproc) == FAIL)
                    ThrowError(CDBLIBERR::eDbRpcExec);

                if (dbresults(m_dbproc) != SUCCEED)
                    ThrowError(CDBLIBERR::eDbResults);

                if (dbnextrow(m_dbproc) != REG_ROW)
                    ThrowError(CDBLIBERR::eDbNextRow);

                if (dbnumcols(m_dbproc) != 10)
                    ThrowError(CDBLIBERR::eWrongNumCols);

                for (i=0; i<10; i++)
                {
                    if (pData = dbdata(m_dbproc, i+1))
                        m_txn.Delivery.o_id[i] = (*(DBINT
*)pData);
                }

                DiscardNextRows(0);
                DiscardNextResults(0);

                m_txn.Delivery.exec_status_code = eOK;
                return;
            }
            catch (CSQLERR *e)
            {
                if ((e->m_msgno != 1205) || (++iTryCount > iMaxRetries))
                    throw;

                // hit deadlock; backoff for increasingly longer period
                delete e;
                Sleep(10 * iTryCount);
            }
        }
    }
}
// while (TRUE)

void CTPCC_DBLIB::ResetError()
{
    if (m_DbLibErr != NULL)
    {
        delete m_DbLibErr;
        m_DbLibErr = (CDBLIBERR*)NULL;
    }

    if (m_SqlErr != NULL)
```

Appendix A - Application Source Code

```
{
    delete m_SqlErr;
    m_SqlErr = (CSQLERR*)NULL;
}
return;
}
```

db_dblib_dll/src/tpcc_dblib.h

```
/* FILE: TPCC_DBLIB.H
 * Microsoft TPC-C Kit Ver. 4.20.000
 * Copyright Microsoft, 1999
 * All Rights Reserved
 * Version 4.10.000 audited by Richard Gimarc,
 * Performance Metrics, 3/17/99
 * PURPOSE: Header file for TPC-C txn class implementation.
 * Change history:
 * 4.20.000 - updated rev number to match kit
 */
#pragma once

#ifndef PDBPROCESS
#define DBPROCESS void // dbprocess structure type
typedef DBPROCESS * PDBPROCESS;
#endif

// need to declare functions for import, unless define has already been created
// by the DLL's .cpp module for export.
#ifndef DllDecl
#define DllDecl __declspec( dllimport )
#endif

class CSQLERR : public CBaseErr
{
public:
    CSQLERR(void)
    {
        m_msgno = 0;
        m_msgstate = 0;
        m_severity = 0;
        m_msgtext = NULL;
    };

    ~CSQLERR()
    {
        delete [] m_msgtext;
    };

    int m_msgno;
    int m_msgstate;
    int m_severity;
    char *m_msgtext;

    int ErrorType() {return ERR_TYPE_DBLIB;};
    int ErrorNum() {return m_msgno;};
};
```

```
char *ErrorText() {return m_msgtext;};
};

class CDBLIBERR : public CBaseErr
{
public:
    enum ACTION
    {
        eNone,
        eUnknown,
        eLogin, // error from
        eDbOpen, // error from dbopen
        eDbUse, // error from dbuse
        eDbSqlExec, // error from
        eDbSet, // error from one
        eDbNextRow, // error from
        eWrongRowCount, // more or less rows returned
        eWrongNumCols, // more or less columns
        eDbResults, // error from
        eDbRpcExec, // error from
        eDbSetMaxProcs, // error from dbsetmaxprocs
        eDbProcHandler, // error from either
    };

    CDBLIBERR(ACTION eAction, int severity = 0, int dberror = 0, int
oserr = 0)
    {
        m_eAction = eAction;
        m_severity = severity;
        m_dberror = dberror;
        m_oserr = oserr;

        m_dberrstr = NULL;
        m_oserrstr = NULL;
    };

    ~CDBLIBERR()
    {
        delete [] m_dberrstr;
        delete [] m_oserrstr;
    };

    ACTION m_eAction;
    int m_severity;
    int m_dberror;
    int m_oserr;
    char *m_dberrstr;
    char *m_oserrstr;

    int ErrorType() {return ERR_TYPE_DBLIB;};
    int ErrorNum() {return m_dberror;};
    char *ErrorText() {return m_dberrstr;};
};
```

Appendix A - Application Source Code

```
};

class CTPCC_DBLIB_ERR : public CBaseErr
{
public:
    enum CTPCC_DBLIB_ERRS
    {
        ERR_WRONG_SP_VERSION = 1, // "Wrong version of stored
procs on database server"
        ERR_INVALID_CUST, // "Invalid
Customer id,name."
        ERR_NO_SUCH_ORDER // "No orders found
for customer."
    };

    CTPCC_DBLIB_ERR( int iErr ) { m_errno = iErr; };

    int m_errno;

    int ErrorType() {return ERR_TYPE_TPCC_DBLIB;};
    int ErrorNum() {return m_errno;};

    char *ErrorText();
};

class DllDecl CTPCC_DBLIB : public CTPCC_BASE
{
private:
    // declare variables and private functions here...
    PDBPROCESS m_dbproc;
    CDBLIBERR *m_DbLibErr; // not allocated until needed
(maybe never)
    CSQLErr *m_SqlErr; // not
allocated until needed (maybe never)
    int m_MaxRetries; // retry
count on deadlock

    void DiscardNextRows(int iExpectedCount);
    void DiscardNextResults(int iExpectedCount);
    void ThrowError( CDBLIBERR::ACTION eAction );
    void ResetError();

    union
    {
        NEW_ORDER_DATA NewOrder;
        PAYMENT_DATA Payment;
        DELIVERY_DATA Delivery;
        STOCK_LEVEL_DATA StockLevel;
        ORDER_STATUS_DATA OrderStatus;
        m_txn;
    }

public:
    CTPCC_DBLIB(LPCSTR szServer, LPCSTR szUser, LPCSTR szPassword, LPCSTR
szHost, LPCSTR szDatabase );
    ~CTPCC_DBLIB(void);

    inline PNEW_ORDER_DATA BuffAddr_NewOrder()
    { return &m_txn.NewOrder; };
    inline PPAYMENT_DATA BuffAddr_Payment()
    { return &m_txn.Payment; };
    inline PDELIVERY_DATA BuffAddr_Delivery()
    { return &m_txn.Delivery; };
};
```

```
inline PSTOCK_LEVEL_DATA BuffAddr_StockLevel() { return
&m_txn.StockLevel; };
inline PORDER_STATUS_DATA BuffAddr_OrderStatus() { return
&m_txn.OrderStatus; };

void NewOrder ();
void Payment ();
void Delivery ();
void StockLevel ();
void OrderStatus ();

// these are public because they must be called from the dblib
err_handler and msg_handler
// outside of the class
void SetDbLibError(int severity, int dberr, int oserr, LPCSTR
dberrstr, LPCSTR oserrstr);
void SetSqlError( int msgno, int msgstate, int severity, LPCSTR
msgtext );
};

extern "C" DllDecl CTPCC_DBLIB* CTPCC_DBLIB_new
( LPCSTR szServer, LPCSTR szUser, LPCSTR szPassword, LPCSTR szHost, LPCSTR
szDatabase );

typedef CTPCC_DBLIB* (TYPE_CTPCC_DBLIB)(LPCSTR, LPCSTR, LPCSTR, LPCSTR, LPCSTR);
```

tm_com_dll/src/tpcc_com.cpp

```
/* FILE: TPCC_COM.CPP
Microsoft TPC-C Kit Ver. 4.20.000
Copyright Microsoft, 1999
All Rights Reserved
not yet audited
PURPOSE: Source file for TPC-C COM+ class implementation.
Contact: Charles Levine (clevine@microsoft.com)
Change history:
4.20.000 - first version
*/

// needed for CoinitializeEx
#define _WIN32_WINNT 0x0400

#include <windows.h>

// need to declare functions for export
#define DllDecl __declspec( dllexport )

#include "..\..\common\src\trans.h" //tpckit transaction header contains
definitions of structures specific to TPC-C
#include "..\..\common\src\error.h"
#include "..\..\common\src\txn_base.h"
#include "tpcc_com.h"

#include "..\..\tpcc_com_ps\src\tpcc_com_ps_i.c"
```

Appendix A - Application Source Code

```
#include "..\..\tpcc_com_all\src\tpcc_com_all_i.c"

// wrapper routine for class constructor
__declspec(dllexport) CTPCC_COM* CTPCC_COM_new(BOOL bSinglePool)
{
    return new CTPCC_COM(bSinglePool);
}

CTPCC_COM::CTPCC_COM(BOOL bSinglePool)
{
    HRESULT hr = NULL;
    long lRet = 0;
    ULONG ulTmpSize = 0;

    m_pTxn = NULL;
    m_pNewOrder = NULL;
    m_pPayment = NULL;
    m_pStockLevel = NULL;
    m_pOrderStatus = NULL;

    m_bSinglePool = bSinglePool;

    ulTmpSize = (ULONG) sizeof(COM_DATA);
    VariantInit(&m_vTxn);
    m_vTxn.vt = VT_SAFEARRAY;

    m_vTxn.parray = SafeArrayCreateVector(VT_UI1, ulTmpSize, ulTmpSize);
    if (!m_vTxn.parray)
        throw new CCOMERR( E_FAIL );

    memset((void*)m_vTxn.parray->pvData, 0, ulTmpSize);
    m_pTxn = (COM_DATA*)m_vTxn.parray->pvData;

    hr = CoInitializeEx(NULL, COINIT_MULTITHREADED);
    if (FAILED(hr))
    {
        throw new CCOMERR( hr );
    }

    // create components
    if (m_bSinglePool)
    {
        hr = CoCreateInstance(CLSID_TPCC, NULL, CLSCTX_SERVER, IID_ITPCC,
        (void **)&m_pNewOrder);
        if (FAILED(hr))
            throw new CCOMERR(hr);

        // all txns will use same component
        m_pPayment = m_pNewOrder;
        m_pStockLevel = m_pNewOrder;
        m_pOrderStatus = m_pNewOrder;
    }
    else
    {
        // use different components for each txn

        hr = CoCreateInstance(CLSID_NewOrder, NULL, CLSCTX_SERVER, IID_ITPCC,
        (void **)&m_pNewOrder);
        if (FAILED(hr))
            throw new CCOMERR(hr);

        hr = CoCreateInstance(CLSID_Payment, NULL, CLSCTX_SERVER, IID_ITPCC,
        (void **)&m_pPayment);
```

```
        if (FAILED(hr))
            throw new CCOMERR(hr);

        hr = CoCreateInstance(CLSID_StockLevel, NULL, CLSCTX_SERVER,
        IID_ITPCC, (void **)&m_pStockLevel);
        if (FAILED(hr))
            throw new CCOMERR(hr);

        hr = CoCreateInstance(CLSID_OrderStatus, NULL, CLSCTX_SERVER,
        IID_ITPCC, (void **)&m_pOrderStatus);
        if (FAILED(hr))
            throw new CCOMERR(hr);
    }

    // call setcomplete to release each component back into pool
    hr = m_pNewOrder->CallSetComplete();
    if (FAILED(hr))
        throw new CCOMERR(hr);

    if (!m_bSinglePool)
    {
        hr = m_pPayment->CallSetComplete();
        if (FAILED(hr))
            throw new CCOMERR(hr);

        hr = m_pStockLevel->CallSetComplete();
        if (FAILED(hr))
            throw new CCOMERR(hr);

        hr = m_pOrderStatus->CallSetComplete();
        if (FAILED(hr))
            throw new CCOMERR(hr);
    }
}

CTPCC_COM::~CTPCC_COM()
{
    if (m_pTxn)
        SafeArrayDestroy(m_vTxn.parray);

    ReleaseInterface(m_pNewOrder);
    if (!m_bSinglePool)
    {
        ReleaseInterface(m_pPayment);
        ReleaseInterface(m_pStockLevel);
        ReleaseInterface(m_pOrderStatus);
    }
    CoUninitialize();
}

void CTPCC_COM::NewOrder()
{
    VARIANT vTxn_out;

    HRESULT hr = m_pNewOrder->NewOrder(m_vTxn, &vTxn_out);
    if (FAILED(hr))
        throw new CCOMERR( hr );

    memcpy(m_pTxn, (void *)vTxn_out.parray->pvData, vTxn_out.parray-
    >rgsabound[0].cElements);
    SafeArrayDestroy(vTxn_out.parray);

    if ( m_pTxn->ErrorType != ERR_SUCCESS )
        throw new CCOMERR( m_pTxn->ErrorType, m_pTxn->error );
```

Appendix A - Application Source Code

```
}
void CTPCC_COM::Payment()
{
    VARIANT vTxn_out;

    HRESULT hr = m_pPayment->Payment(m_vTxn, &vTxn_out);
    if (FAILED(hr))
        throw new CCOMERR( hr );
    memcpy(m_pTxn, (void *)vTxn_out.parray->pvData, vTxn_out.parray-
>rgsabound[0].cElements);
    SafeArrayDestroy(vTxn_out.parray);

    if ( m_pTxn->ErrorType != ERR_SUCCESS )
        throw new CCOMERR( m_pTxn->ErrorType, m_pTxn->error );
}

void CTPCC_COM::StockLevel()
{
    VARIANT vTxn_out;

    HRESULT hr = m_pStockLevel->StockLevel(m_vTxn, &vTxn_out);
    if (FAILED(hr))
        throw new CCOMERR( hr );
    memcpy(m_pTxn, (void *)vTxn_out.parray->pvData, vTxn_out.parray-
>rgsabound[0].cElements);
    SafeArrayDestroy(vTxn_out.parray);

    if ( m_pTxn->ErrorType != ERR_SUCCESS )
        throw new CCOMERR( m_pTxn->ErrorType, m_pTxn->error );
}

void CTPCC_COM::OrderStatus()
{
    VARIANT vTxn_out;

    HRESULT hr = m_pOrderStatus->OrderStatus(m_vTxn, &vTxn_out);
    if (FAILED(hr))
        throw new CCOMERR( hr );
    memcpy(m_pTxn, (void *)vTxn_out.parray->pvData, vTxn_out.parray-
>rgsabound[0].cElements);
    SafeArrayDestroy(vTxn_out.parray);

    if ( m_pTxn->ErrorType != ERR_SUCCESS )
        throw new CCOMERR( m_pTxn->ErrorType, m_pTxn->error );
}
```

tm_com_dll/src/tpcc_com.h

```
/*      FILE:          TPCC_COM.H
 *
 *      Microsoft TPC-C Kit Ver. 4.20.000
 *      Copyright Microsoft, 1999
 *
 *      All Rights Reserved
 *
 *      not yet audited
 *
 *      PURPOSE: Header file for TPC-C COM+ class implementation.
 *
 *      Change history:
```

```
*      4.20.000 - first version
*/

#pragma once

#include <stdio.h>
#include "..\..\tpcc_com_ps\src\tpcc_com_ps.h"

// need to declare functions for import, unless define has already been created
// by the DLL's .cpp module for export.
#ifdef DllDecl
#define DllDecl __declspec( dllimport )
#endif

class CCOMERR : public CBaseErr
{
private:
    char m_szErrorText[64];

public:
    // use this interface for genuine COM errors
    CCOMERR( HRESULT hr )
    {
        m_hr = hr;
        m_iErrorType = 0;
        m_iError = 0;
    }

    // use this interface to impersonate a non-COM error type
    CCOMERR( int iErrorType, int iError )
    {
        m_iErrorType = iErrorType;
        m_iError = iError;
        m_hr = S_OK;
    }

    int m_hr;
    int m_iErrorType;
    int m_iError;

    // A CCOMERR class can impersonate another class, which happens if
    the error // was not actually a COM Services error, but was simply transmitted
    back via COM.

    int ErrorType()
    {
        if (m_iErrorType == 0)
            return ERR_TYPE_COM;
        else
            return m_iErrorType;
    }

    int ErrorNum() {return m_hr;}

    char *ErrorText()
    {
        if (m_hr == S_OK)
            sprintf( m_szErrorText, "Error: Class %d, error #
%d", m_iErrorType, m_iError );
        else
            sprintf( m_szErrorText, "Error: COM HRESULT %x",
m_hr );

        return m_szErrorText;
    }
};
```

Appendix A - Application Source Code

```
};
}
class DllDecl CTPCC_COM : public CTPCC_BASE
{
private:
    BOOL m_bSinglePool;

    // COM Interface pointers
    ITPCC* m_pNewOrder;
    ITPCC* m_pPayment;
    ITPCC* m_pStockLevel;
    ITPCC* m_pOrderStatus;

    struct COM_DATA
    {
        int ErrorType;
        int error;
        union
        {
            NEW_ORDER_DATA NewOrder;
            PAYMENT_DATA Payment;
            DELIVERY_DATA Delivery;
            STOCK_LEVEL_DATA StockLevel;
            ORDER_STATUS_DATA OrderStatus;
        } u;
    } *m_pTxn;

public:
    VARIANT m_vTxn;
    CTPCC_COM(BOOL bSinglePool);
    ~CTPCC_COM(void);

    inline PNEW_ORDER_DATA BuffAddr_NewOrder();
    { return &m_pTxn->u.NewOrder; };
    inline PPAYMENT_DATA BuffAddr_Payment();
    { return &m_pTxn->u.Payment; };
    inline PDELIVERY_DATA BuffAddr_Delivery();
    { return &m_pTxn->u.Delivery; };
    inline PSTOCK_LEVEL_DATA BuffAddr_StockLevel() { return
&m_pTxn->u.StockLevel; };
    inline PORDER_STATUS_DATA BuffAddr_OrderStatus() { return
&m_pTxn->u.OrderStatus; };

    void NewOrder ();
    void Payment ();
    void StockLevel ();
    void OrderStatus ();
    void Delivery () { throw new CCOMERR(E_NOTIMPL); }

// not supported
};

inline void ReleaseInterface(IUnknown *pUnk)
{
    if (pUnk)
    {
        pUnk->Release();
        pUnk = NULL;
    }
}
}
```

```
// wrapper routine for class constructor
extern "C" __declspec(dllexport) CTPCC_COM* CTPCC_COM_new(BOOL);
typedef CTPCC_COM* (TYPE_CTPCC_COM)(BOOL);
```

tpcc_com_all/src/methods.h

```
/* FILE: METHODS.H
 * Microsoft TPC-C Kit Ver. 4.20.000
 * Copyright Microsoft, 1999
 * All Rights Reserved
 *
 * not yet audited
 *
 * PURPOSE: Header file for COM components.
 *
 * Change history:
 * 4.20.000 - first version
 */
```

```
enum COMPONENT_ERROR
{
    ERR_MISSING_REGISTRY_ENTRIES = 1,
    ERR_LOADDLL_FAILED,
    ERR_GETPROCADDR_FAILED,
    ERR_UNKNOWN_DB_PROTOCOL
};

class CCOMPONENT_ERR : public CBaseErr
{
public:
    CCOMPONENT_ERR(COMPONENT_ERROR Err)
    {
        m_Error = Err;
        m_szTextDetail = NULL;
        m_SystemErr = 0;
        m_szErrorText = NULL;
    };

    CCOMPONENT_ERR(COMPONENT_ERROR Err, char
*szTextDetail, DWORD dwSystemErr)
    {
        m_Error = Err;
        m_szTextDetail = new
char[strlen(szTextDetail)+1];
```

Appendix A - Application Source Code

```
        strcpy( m_szTextDetail, szTextDetail );
        m_SystemErr = dwSystemErr;
        m_szErrorText = NULL;
    };

~CCOMPONENT_ERR()
{
    if ( m_szTextDetail != NULL)
        delete [] m_szTextDetail;
    if ( m_szErrorText != NULL)
        delete [] m_szErrorText;
};

COMPONENT_ERROR      m_Error;
char                 *m_szTextDetail;
char                 *m_szErrorText;
DWORD                m_SystemErr;

int ErrorType() {return ERR_TYPE_COMPONENT;};
int ErrorNum() {return m_Error;};
char *ErrorText();
};

static void WriteMessageToEventLog(LPTSTR lpszMsg);

////////////////////////////////////
////////
// CTPCC_Common
class CTPCC_Common :
    public ITPCC,
    public IObjectControl,
    public IObjectConstruct,
    public CComObjectRootEx<CComSingleThreadModel>
{
public:
    BEGIN_COM_MAP(CTPCC_Common)
        COM_INTERFACE_ENTRY(ITPCC)
        COM_INTERFACE_ENTRY(IObjectControl)
        COM_INTERFACE_ENTRY(IObjectConstruct)
    END_COM_MAP()

    CTPCC_Common();
    ~CTPCC_Common();

// ITPCC
```

```
public:
    HRESULT __stdcall NewOrder(          VARIANT txn_in,
    VARIANT* txn_out);
    HRESULT __stdcall Payment(          VARIANT txn_in,
    VARIANT* txn_out);
    HRESULT __stdcall Delivery(         VARIANT txn_in,
    VARIANT* txn_out) {return E_NOTIMPL;};
    HRESULT __stdcall StockLevel(       VARIANT txn_in, VARIANT*
    txn_out);
    HRESULT __stdcall OrderStatus(      VARIANT txn_in,
    VARIANT* txn_out);

    HRESULT __stdcall CallSetComplete();

// IObjectControl
    STDMETHODCALLTYPE CanBePooled() { return m_bCanBePooled;
}
    STDMETHODCALLTYPE Activate() { return S_OK; } // we don't
support COM Services transactions (no enlistment)
    STDMETHODCALLTYPE Deactivate() { /* nothing to do */ }

// IObjectConstruct
    STDMETHODCALLTYPE Construct(IDispatch * pUnk);

// helper methods
private:
    BOOL                m_bCanBePooled;
    CTPCC_BASE         *m_pTxn;

    struct COM_DATA
    {
        int retval;
        int error;
        union
        {
            NEW_ORDER_DATA      NewOrder;
            PAYMENT_DATA         Payment;
            DELIVERY_DATA        Delivery;
            STOCK_LEVEL_DATA     StockLevel;
            ORDER_STATUS_DATA    OrderStatus;
        } u;
    };
};

////////////////////////////////////
////////
```

Appendix A - Application Source Code

```
// CTPCC
class CTPCC :
    public CTPCC_Common,
    public CComCoClass<CTPCC, &CLSID_TPCC>
{
public:
DECLARE_REGISTRY_RESOURCEID(IDR_TPCC)

BEGIN_COM_MAP(CTPCC)
    COM_INTERFACE_ENTRY2(IUnknown, CComObjectRootEx)
    COM_INTERFACE_ENTRY_CHAIN(CTPCC_Common)
END_COM_MAP()

};

////////////////////////////////////
////////////////////////////////////
// CNewOrder
class CNewOrder :
    public CTPCC_Common,
    public CComCoClass<CNewOrder, &CLSID_NewOrder>
{
public:
DECLARE_REGISTRY_RESOURCEID(IDR_NEWORDER)

BEGIN_COM_MAP(CNewOrder)
    COM_INTERFACE_ENTRY2(IUnknown, CComObjectRootEx)
    COM_INTERFACE_ENTRY_CHAIN(CTPCC_Common)
END_COM_MAP()

// ITPCC
public:
// HRESULT __stdcall NewOrder(          VARIANT txn_in,
VARIANT* txn_out) {return E_NOTIMPL;}
    HRESULT __stdcall Payment(          VARIANT txn_in,
VARIANT* txn_out) {return E_NOTIMPL;}
    HRESULT __stdcall StockLevel( VARIANT txn_in, VARIANT*
txn_out) {return E_NOTIMPL;}
    HRESULT __stdcall OrderStatus(      VARIANT txn_in,
VARIANT* txn_out) {return E_NOTIMPL;}
};

////////////////////////////////////
////////////////////////////////////
// COrderStatus
```

```
class COrderStatus :
    public CTPCC_Common,
    public CComCoClass<COrderStatus, &CLSID_OrderStatus>
{
public:
DECLARE_REGISTRY_RESOURCEID(IDR_ORDERSTATUS)

BEGIN_COM_MAP(COrderStatus)
    COM_INTERFACE_ENTRY2(IUnknown, CComObjectRootEx)
    COM_INTERFACE_ENTRY_CHAIN(CTPCC_Common)
END_COM_MAP()

// ITPCC
public:
    HRESULT __stdcall NewOrder(          VARIANT txn_in,
VARIANT* txn_out) {return E_NOTIMPL;}
    HRESULT __stdcall Payment(          VARIANT txn_in,
VARIANT* txn_out) {return E_NOTIMPL;}
    HRESULT __stdcall StockLevel( VARIANT txn_in, VARIANT*
txn_out) {return E_NOTIMPL;}
    // HRESULT __stdcall OrderStatus(      VARIANT txn_in,
VARIANT* txn_out) {return E_NOTIMPL;}
};

////////////////////////////////////
////////////////////////////////////
// CPayment
class CPayment :
    public CTPCC_Common,
    public CComCoClass<CPayment, &CLSID_Payment>
{
public:
DECLARE_REGISTRY_RESOURCEID(IDR_PAYMENT)

BEGIN_COM_MAP(CPayment)
    COM_INTERFACE_ENTRY2(IUnknown, CComObjectRootEx)
    COM_INTERFACE_ENTRY_CHAIN(CTPCC_Common)
END_COM_MAP()

// ITPCC
public:
    HRESULT __stdcall NewOrder(          VARIANT txn_in,
VARIANT* txn_out) {return E_NOTIMPL;}
    // HRESULT __stdcall Payment(          VARIANT txn_in,
VARIANT* txn_out) {return E_NOTIMPL;}
};
```

Appendix A - Application Source Code

```
        HRESULT __stdcall StockLevel( VARIANT txn_in, VARIANT*
txn_out) {return E_NOTIMPL;}
        HRESULT __stdcall OrderStatus(          VARIANT txn_in,
VARIANT* txn_out) {return E_NOTIMPL;}
};

////////////////////////////////////
////////
// CStockLevel
class CStockLevel :
    public CTPCC_Common,
    public CComCoClass<CStockLevel, &CLSID_StockLevel>
{
public:
DECLARE_REGISTRY_RESOURCEID(IDR_STOCKLEVEL)

BEGIN_COM_MAP(CStockLevel)
    COM_INTERFACE_ENTRY2(IUnknown, CComObjectRootEx)
    COM_INTERFACE_ENTRY_CHAIN(CTPCC_Common)
END_COM_MAP()

// ITPCC
public:
    HRESULT __stdcall NewOrder(          VARIANT txn_in,
VARIANT* txn_out) {return E_NOTIMPL;}
    HRESULT __stdcall Payment(          VARIANT txn_in,
VARIANT* txn_out) {return E_NOTIMPL;}
    // HRESULT __stdcall StockLevel( VARIANT txn_in, VARIANT*
txn_out) {return E_NOTIMPL;}
    HRESULT __stdcall OrderStatus(          VARIANT txn_in,
VARIANT* txn_out) {return E_NOTIMPL;}
};
```

tpcc_com_all/src/resource.h

```
//{{NO_DEPENDENCIES}}
// Microsoft Developer Studio generated include file.
// Used by tpcc_com_all.rc
//
#define IDS_PROJNAME                100
#define IDR_TPCC                    101
#define IDR_NEWORDER                102
#define IDR_ORDERSTATUS              103
#define IDR_PAYMENT                  104
#define IDR_STOCKLEVEL              105
```

```
// Next default values for new objects
//
#ifdef APSTUDIO_INVOKED
#ifndef APSTUDIO_READONLY_SYMBOLS
#define _APS_NEXT_RESOURCE_VALUE        202
#define _APS_NEXT_COMMAND_VALUE        32768
#define _APS_NEXT_CONTROL_VALUE        201
#define _APS_NEXT_SYMED_VALUE          106
#endif
#endif
```

tpcc_com_all/src/tpcc_com_all.cpp

```
/*      FILE:                TPCC_COM_ALL.CPP
 *      Microsoft TPC-C Kit Ver. 4.20.000
 *      Copyright Microsoft, 1999
 *
 *      All Rights Reserved
 *
 *      Version 4.10.000 audited by Richard Gimarc,
Performance Metrics, 3/17/99
 *
 *      PURPOSE: Implementation for TPC-C Tuxedo class.
 *      Contact: Charles Levine (clevine@microsoft.com)
 *
 *      Change history:
 *      4.20.000 - updated rev number to match kit
 */

#define STRICT
#define _WIN32_WINNT 0x0400
#define _ATL_APARTMENT_THREADED

#include <stdio.h>
#include <atlbase.h>
//You may derive a class from CComModule and use it if you want to override
//something, but do not change the name of _Module
extern CComModule _Module;

#include <atlcom.h>
#include <initguid.h>
#include <transact.h>
#include <atlimpl.cpp>
#include <comsvcs.h>

#include <sqltypes.h>
#include <sql.h>
#include <sqlext.h>

#include "tpcc_com_ps.h"
#include "..\..\common\src\trans.h" //tpckit
transaction header contains definitions of structures specific to TPC-C
#include "..\..\common\src\txn_base.h"
#include "..\..\common\src\error.h"
#include "..\..\common\src\ReadRegistry.h"
#include "..\..\db_dblib_dll\src\tpcc_dblib.h" // DBLIB implementation of
TPC-C txns
#include "..\..\db_odbc_dll\src\tpcc_odbc.h" // ODBC implementation of
TPC-C txns
```

Appendix A - Application Source Code

```
#include "resource.h"
#include "tpcc_com_all.h"
#include "tpcc_com_all_i.c"
#include "Methods.h"
#include "..\..\tpcc_com_ps\src\tpcc_com_ps_i.c"
#include "..\..\common\src\ReadRegistry.cpp"

CComModule _Module;

BEGIN_OBJECT_MAP(ObjectMap)
    OBJECT_ENTRY(CLSID_TPCC, CTPCC)
    OBJECT_ENTRY(CLSID_NewOrder, CNewOrder)
    OBJECT_ENTRY(CLSID_OrderStatus, COrderStatus)
    OBJECT_ENTRY(CLSID_Payment, CPayment)
    OBJECT_ENTRY(CLSID_StockLevel, CStockLevel)
END_OBJECT_MAP()

// configuration settings from registry
TPCCREGISTRYDATA Reg;
char szMyComputerName[MAX_COMPUTERNAME_LENGTH+1];

static HINSTANCE hLibInstanceDb = NULL;

TYPE_CTPCC_DBLIB *pCTPCC_DBLIB_new;
TYPE_CTPCC_ODBC *pCTPCC_ODBC_new;

////////////////////////////////////
// DLL Entry Point
extern "C"
BOOL WINAPI DllMain(HINSTANCE hInstance, DWORD dwReason, LPVOID /**lpReserved*/)
{
    char szDllName[128];

    try
    {
        if (dwReason == DLL_PROCESS_ATTACH)
        {
            _Module.Init(ObjectMap, hInstance);
            DisableThreadLibraryCalls(hInstance);

            DWORD dwSize = MAX_COMPUTERNAME_LENGTH+1;
            GetComputerName(szMyComputerName, &dwSize);
            szMyComputerName[dwSize] = 0;

            if ( ReadTPCCRegistrySettings( &Reg ) )
                throw new CCOMPONENT_ERR(
ERR_MISSING_REGISTRY_ENTRIES );

            if (Reg.eDB_Protocol == DBLIB)
            {
                strcpy( szDllName, Reg.szPath );
                strcat( szDllName, "tpcc_dblib.dll" );
                hLibInstanceDb = LoadLibrary( szDllName );
                if (hLibInstanceDb == NULL)
                    throw new CCOMPONENT_ERR(
ERR_LOADDLL_FAILED, szDllName, GetLastError() );

                // get function pointer to wrapper for class
                constructor
                pCTPCC_DBLIB_new = (TYPE_CTPCC_DBLIB*)
                GetProcAddress(hLibInstanceDb, "CTPCC_DBLIB_new");
                if (pCTPCC_DBLIB_new == NULL)
                    throw new CCOMPONENT_ERR(
ERR_GETPROCADDR_FAILED, szDllName, GetLastError() );
            }
            else if (Reg.eDB_Protocol == ODBC)
            {
                strcpy( szDllName, Reg.szPath );
                strcat( szDllName, "tpcc_odbc.dll" );
                hLibInstanceDb = LoadLibrary( szDllName );
                if (hLibInstanceDb == NULL)
                    throw new CCOMPONENT_ERR(
ERR_LOADDLL_FAILED, szDllName, GetLastError() );

                // get function pointer to wrapper for class
                constructor
                pCTPCC_ODBC_new = (TYPE_CTPCC_ODBC*)
                GetProcAddress(hLibInstanceDb, "CTPCC_ODBC_new");
                if (pCTPCC_ODBC_new == NULL)
                    throw new CCOMPONENT_ERR(
ERR_GETPROCADDR_FAILED, szDllName, GetLastError() );
            }
            else
                throw new CCOMPONENT_ERR( ERR_UNKNOWN_DB_PROTOCOL
);

        }
        else if (dwReason == DLL_PROCESS_DETACH)
            _Module.Term();
    }
    catch (CBaseErr *e)
    {
        WriteMessageToEventLog(e->ErrorText());
        delete e;
        return FALSE;
    }
    catch (...)
    {
        WriteMessageToEventLog(TEXT("Unhandled exception in object
DllMain"));
        return FALSE;
    }

    return TRUE; // OK
}

////////////////////////////////////
// Used to determine whether the DLL can be unloaded by OLE
STDAPI DllCanUnloadNow(void)
{
    return (_Module.GetLockCount()==0) ? S_OK : S_FALSE;
}

////////////////////////////////////
// Returns a class factory to create an object of the requested type
STDAPI DllGetClassObject(REFCLSID rclsid, REFIID riid, LPVOID* ppv)
{
    return _Module.GetClassObject(rclsid, riid, ppv);
}
```

```
pCTPCC_DBLIB_new = (TYPE_CTPCC_DBLIB*)
GetProcAddress(hLibInstanceDb, "CTPCC_DBLIB_new");
if (pCTPCC_DBLIB_new == NULL)
    throw new CCOMPONENT_ERR(
ERR_GETPROCADDR_FAILED, szDllName, GetLastError() );
else if (Reg.eDB_Protocol == ODBC)
{
    strcpy( szDllName, Reg.szPath );
    strcat( szDllName, "tpcc_odbc.dll" );
    hLibInstanceDb = LoadLibrary( szDllName );
    if (hLibInstanceDb == NULL)
        throw new CCOMPONENT_ERR(
ERR_LOADDLL_FAILED, szDllName, GetLastError() );

    // get function pointer to wrapper for class
    constructor
    pCTPCC_ODBC_new = (TYPE_CTPCC_ODBC*)
    GetProcAddress(hLibInstanceDb, "CTPCC_ODBC_new");
    if (pCTPCC_ODBC_new == NULL)
        throw new CCOMPONENT_ERR(
ERR_GETPROCADDR_FAILED, szDllName, GetLastError() );
    else
        throw new CCOMPONENT_ERR( ERR_UNKNOWN_DB_PROTOCOL
);

}
else if (dwReason == DLL_PROCESS_DETACH)
    _Module.Term();
}
catch (CBaseErr *e)
{
    WriteMessageToEventLog(e->ErrorText());
    delete e;
    return FALSE;
}
catch (...)
{
    WriteMessageToEventLog(TEXT("Unhandled exception in object
DllMain"));
    return FALSE;
}

return TRUE; // OK
}

////////////////////////////////////
// Used to determine whether the DLL can be unloaded by OLE
STDAPI DllCanUnloadNow(void)
{
    return (_Module.GetLockCount()==0) ? S_OK : S_FALSE;
}

////////////////////////////////////
// Returns a class factory to create an object of the requested type
STDAPI DllGetClassObject(REFCLSID rclsid, REFIID riid, LPVOID* ppv)
{
    return _Module.GetClassObject(rclsid, riid, ppv);
}
```

Appendix A - Application Source Code

```
////////////////////////////////////
// DllRegisterServer - Adds entries to the system registry
STDAPI DllRegisterServer(void)
{
    // registers object, typelib and all interfaces in typelib
    return _Module.RegisterServer(TRUE);
}

////////////////////////////////////
// DllUnregisterServer - Removes entries from the system registry
STDAPI DllUnregisterServer(void)
{
    _Module.UnregisterServer();
    return S_OK;
}

static void WriteMessageToEventLog(LPTSTR lpszMsg)
{
    TCHAR    szMsg[256];
    HANDLE   hEventSource;
    LPTSTR   lpszStrings[2];

    // Use event logging to log the error.
    //
    hEventSource = RegisterEventSource(NULL, TEXT("tpcc_com_all.dll"));

    _stprintf(szMsg, TEXT("Error in COM+ TPC-C Component: "));
    lpszStrings[0] = szMsg;
    lpszStrings[1] = lpszMsg;

    if (hEventSource != NULL)
    {
        ReportEvent(hEventSource, // handle of event source
            EVENTLOG_ERROR_TYPE, // event type
            0, // event category
            0, // event ID
            NULL, // current user's SID
            2, // strings in lpszStrings
            0, // no bytes of raw data
            (LPCTSTR *)lpszStrings, // array of error strings
            NULL); // no raw data

        (VOID) DeregisterEventSource(hEventSource);
    }
}

inline void ReleaseInterface(IUnknown *pUnk)
{
    if (pUnk)
    {
        pUnk->Release();
        pUnk = NULL;
    }
}

/* FUNCTION: CCOMPONENT_ERR::ErrorText
 *
 */

char* CCOMPONENT_ERR::ErrorText(void)
```

```
{
    static SERRORMSG errorMsgs[] =
    {
        { ERR_MISSING_REGISTRY_ENTRIES, "Required entries missing
from registry." },
        { ERR_LOADDLL_FAILED, "Load of DLL
failed. DLL=" },
        { ERR_GETPROCADDR_FAILED, "Could not map proc in DLL.
GetProcAddr. DLL=" },
        { ERR_UNKNOWN_DB_PROTOCOL, "Unknown database protocol
specified in registry." },
        { 0, "" }
    };

    char szTmp[256];
    int i = 0;
    while (TRUE)
    {
        if (errorMsgs[i].szMsg[0] == 0)
        {
            strcpy( szTmp, "Unknown error number." );
            break;
        }
        if (m_Error == errorMsgs[i].iError)
        {
            strcpy( szTmp, errorMsgs[i].szMsg );
            break;
        }
        i++;
    }

    if (m_szTextDetail)
        strcat( szTmp, m_szTextDetail );
    if (m_SystemErr)
        wsprintf( szTmp+strlen(szTmp), " Error=%d", m_SystemErr );

    m_szErrorText = new char[strlen(szTmp)+1];
    strcpy( m_szErrorText, szTmp );
    return m_szErrorText;
}

CTPCC_Common::CTPCC_Common()
{
    m_pTxn = NULL;
    m_bCanBePooled = TRUE;
}

CTPCC_Common::~CTPCC_Common()
{
    if (m_pTxn)
        delete m_pTxn;
}

HRESULT CTPCC_Common::CallSetComplete()
{
    IObjectContext* pObjectContext = NULL;

    // get our object context
```

Appendix A - Application Source Code

```
HRESULT hr = CoGetObjectContext( IID_IObjectContext, (void **)&pObjectContext
);
pObjectContext->SetComplete();
ReleaseInterface(pObjectContext);
return hr;
}
//
// called by the ctor activator
//
STDMETHODIMP CTPCC_Common::Construct(IDispatch * pUnk)
{
    // Code to access construction string, if needed later...
    // if (!pUnk)
    //     return E_UNEXPECTED;
    // IObjectConstructString * pString = NULL;
    // HRESULT hr = pUnk->QueryInterface(IID_IObjectConstructString, (void
**) &pString);
    // pString->Release();

    try
    {
        if (Reg.eDB_Protocol == ODBC)
            m_pTxn = pCTPCC_ODBC_new( Reg.szDbServer, Reg.szDbUser,
Reg.szDbPassword, szMyComputerName, Reg.szDbName );
        else if (Reg.eDB_Protocol == DBLIB)
            m_pTxn = pCTPCC_DBLIB_new( Reg.szDbServer, Reg.szDbUser,
Reg.szDbPassword, szMyComputerName, Reg.szDbName );
    }
    catch (CBaseErr *e)
    {
        WriteMessageToEventLog(e->ErrorText());
        delete e;
        return E_FAIL;
    }
    catch (...)
    {
        WriteMessageToEventLog(TEXT("Unhandled exception in object
::Construct"));
        return E_FAIL;
    }

    return S_OK;
}

HRESULT CTPCC_Common::NewOrder(VARIANT txn_in, VARIANT* txn_out)
{
    PNEW_ORDER_DATA pNewOrder;
    COM_DATA *pData;
    try
    {
        pData = (COM_DATA*)txn_in.parray->pvData;
        pNewOrder = m_pTxn->BuffAddr_NewOrder();

        memcpy(pNewOrder, &pData->u.NewOrder, sizeof(NEW_ORDER_DATA));

        m_pTxn->NewOrder(); // do the actual txn

        VariantInit(txn_out);
        txn_out->vt = VT_SAFEARRAY;
        txn_out->parray = SafeArrayCreateVector(VT_UI1,
txn_in.parray-
>rgsabound->cElements,
txn_in.parray-
```

```
txn_in.parray-
>rgsabound->cElements);
        pData = (COM_DATA*) txn_out->parray->pvData;
        memcpy( &pData->u.NewOrder, pNewOrder, sizeof(NEW_ORDER_DATA));

        pData->retval = ERR_SUCCESS;
        pData->error = 0;
        return S_OK;
    }
    catch (CBaseErr *e)
    {
        // check for lost database connection; if yes, component is toast
        if ( ((e->ErrorType() == ERR_TYPE_DBLIB) && (e->ErrorNum() == 10005))
||
10054)) )
            ((e->ErrorType() == ERR_TYPE_ODBC) && (e->ErrorNum() ==
m_bCanBePooled = FALSE;

        pData->retval = e->ErrorType();
        pData->error = e->ErrorNum();
        delete e;
        return E_FAIL;
    }
    catch (...)
    {
        WriteMessageToEventLog(TEXT("Unhandled exception."));
        pData->retval = ERR_TYPE_LOGIC;
        pData->error = 0;
        m_bCanBePooled = FALSE;
        return E_FAIL;
    }
}

HRESULT CTPCC_Common::Payment(VARIANT txn_in, VARIANT* txn_out)
{
    PPAYMENT_DATA pPayment;
    COM_DATA *pData;
    try
    {
        pData = (COM_DATA*)txn_in.parray->pvData;
        pPayment = m_pTxn->BuffAddr_Payment();

        memcpy(pPayment, &pData->u.Payment, sizeof(PAYMENT_DATA));

        m_pTxn->Payment(); // do the actual txn

        VariantInit(txn_out);
        txn_out->vt = VT_SAFEARRAY;
        txn_out->parray = SafeArrayCreateVector( VT_UI1,
txn_in.parray-
>rgsabound->cElements,
txn_in.parray-
>rgsabound->cElements);
        pData = (COM_DATA*) txn_out->parray->pvData;

        memcpy( &pData->u.Payment, pPayment, sizeof(PAYMENT_DATA));

        pData->retval = ERR_SUCCESS;
        pData->error = 0;
        return S_OK;
    }
    catch (CBaseErr *e)
```

Appendix A - Application Source Code

```
{
    // check for lost database connection; if yes, component is toast
    if ( ((e->ErrorType() == ERR_TYPE_DBLIB) && (e->ErrorNum() == 10005))
||
        ((e->ErrorType() == ERR_TYPE_ODBC) && (e->ErrorNum() ==
10054)) )
        m_bCanBePooled = FALSE;

    pData->retval = e->ErrorType();
    pData->error = e->ErrorNum();
    delete e;
    return E_FAIL;
}
catch (...)
{
    WriteMessageToEventLog(TEXT("Unhandled exception."));
    pData->retval = ERR_TYPE_LOGIC;
    pData->error = 0;
    m_bCanBePooled = FALSE;
    return E_FAIL;
}
}
HRESULT CTPCC_Common::StockLevel(VARIANT txn_in, VARIANT* txn_out)
{
    PSTOCK_LEVEL_DATA pStockLevel;
    COM_DATA          *pData;

    try
    {
        pData = (COM_DATA*)txn_in.parray->pvData;
        pStockLevel = m_pTxn->BuffAddr_StockLevel();

        memcpy(pStockLevel, &pData->u.StockLevel, sizeof(STOCK_LEVEL_DATA));
        m_pTxn->StockLevel();

        VariantInit(txn_out);
        txn_out->vt = VT_SAFEARRAY;
        txn_out->parray = SafeArrayCreateVector( VT_UI1,
            txn_in.parray-
>rgsabound->cElements,
            txn_in.parray-
>rgsabound->cElements);
        pData = (COM_DATA*)txn_out->parray->pvData;

        memcpy( &pData->u.StockLevel, pStockLevel, sizeof(STOCK_LEVEL_DATA));

        pData->retval = ERR_SUCCESS;
        pData->error = 0;
        return S_OK;
    }
    catch (CBaseErr *e)
    {
        // check for lost database connection; if yes, component is toast
        if ( ((e->ErrorType() == ERR_TYPE_DBLIB) && (e->ErrorNum() == 10005))
||
            ((e->ErrorType() == ERR_TYPE_ODBC) && (e->ErrorNum() ==
10054)) )
            m_bCanBePooled = FALSE;

        pData->retval = e->ErrorType();
        pData->error = e->ErrorNum();
        delete e;
        return E_FAIL;
    }
}
```

```
delete e;
return E_FAIL;
}
catch (...)
{
    WriteMessageToEventLog(TEXT("Unhandled exception."));
    pData->retval = ERR_TYPE_LOGIC;
    pData->error = 0;
    m_bCanBePooled = FALSE;
    return E_FAIL;
}
}
HRESULT CTPCC_Common::OrderStatus(VARIANT txn_in, VARIANT* txn_out)
{
    PORDER_STATUS_DATA pOrderStatus;
    COM_DATA          *pData;
    try
    {
        pData = (COM_DATA*)txn_in.parray->pvData;
        pOrderStatus = m_pTxn->BuffAddr_OrderStatus();

        memcpy(pOrderStatus, &pData->u.OrderStatus,
            sizeof(ORDER_STATUS_DATA));

        m_pTxn->OrderStatus();

        VariantInit(txn_out);
        txn_out->vt = VT_SAFEARRAY;
        txn_out->parray = SafeArrayCreateVector( VT_UI1,
            txn_in.parray-
>rgsabound->cElements,
            txn_in.parray-
>rgsabound->cElements);
        pData = (COM_DATA*)txn_out->parray->pvData;

        memcpy( &pData->u.OrderStatus, pOrderStatus,
            sizeof(ORDER_STATUS_DATA));

        pData->retval = ERR_SUCCESS;
        pData->error = 0;
        return S_OK;
    }
    catch (CBaseErr *e)
    {
        // check for lost database connection; if yes, component is toast
        if ( ((e->ErrorType() == ERR_TYPE_DBLIB) && (e->ErrorNum() == 10005))
||
            ((e->ErrorType() == ERR_TYPE_ODBC) && (e->ErrorNum() ==
10054)) )
            m_bCanBePooled = FALSE;

        pData->retval = e->ErrorType();
        pData->error = e->ErrorNum();
        delete e;
        return E_FAIL;
    }
    catch (...)
    {
        WriteMessageToEventLog(TEXT("Unhandled exception."));
        pData->retval = ERR_TYPE_LOGIC;
        pData->error = 0;
        m_bCanBePooled = FALSE;
    }
}
```

Appendix A - Application Source Code

```
        return E_FAIL;
    }
}
```

tpcc_com_all/src/tpcc_com_all.def

```
; tpcc_com_all.def : Declares the module parameters.
```

```
LIBRARY      "tpcc_com_all.dll"

EXPORTS
    DllCanUnloadNow      @1 PRIVATE
    DllGetClassObject    @2 PRIVATE
    DllRegisterServer    @3 PRIVATE
    DllUnregisterServer@4 PRIVATE
```

tpcc_com_all/src/tpcc_com_all.h

```
#pragma warning( disable: 4049 ) /* more than 64k source lines */

/* this ALWAYS GENERATED file contains the definitions for the interfaces */

/* File created by MIDL compiler version 5.03.0280 */
/* at Sat Apr 08 16:40:18 2000
*/
/* Compiler settings for .\src\tpcc_com_all.idl:
    Oicf (OptLev=12), Wl, Zp8, env=Win32 (32b run), ms_ext, c_ext
    error checks: allocation ref bounds_check enum stub_data
    VC __declspec() decoration level:
        __declspec(uuid()), __declspec(selectany), __declspec(novtable)
        DECLSPEC_UUID(), MIDL_INTERFACE()
*/
//@@MIDL_FILE_HEADING(  )

/* verify that the <rpcndr.h> version is high enough to compile this file*/
#ifdef __REQUIRED_RPCNDR_H_VERSION__
#define __REQUIRED_RPCNDR_H_VERSION__ 440
#endif

#include "rpc.h"
#include "rpcndr.h"

#ifdef __tpcc_com_all_h__
#define __tpcc_com_all_h__

/* Forward Declarations */

#ifdef __TPCC_FWD_DEFINED__
#define __TPCC_FWD_DEFINED__
```

```
#ifdef __cplusplus
typedef class TPCC TPCC;
#else
typedef struct TPCC TPCC;
#endif /* __cplusplus */

#endif /* __TPCC_FWD_DEFINED__ */

#ifdef __NewOrder_FWD_DEFINED__
#define __NewOrder_FWD_DEFINED__

#ifdef __cplusplus
typedef class NewOrder NewOrder;
#else
typedef struct NewOrder NewOrder;
#endif /* __cplusplus */

#endif /* __NewOrder_FWD_DEFINED__ */

#ifdef __OrderStatus_FWD_DEFINED__
#define __OrderStatus_FWD_DEFINED__

#ifdef __cplusplus
typedef class OrderStatus OrderStatus;
#else
typedef struct OrderStatus OrderStatus;
#endif /* __cplusplus */

#endif /* __OrderStatus_FWD_DEFINED__ */

#ifdef __Payment_FWD_DEFINED__
#define __Payment_FWD_DEFINED__

#ifdef __cplusplus
typedef class Payment Payment;
#else
typedef struct Payment Payment;
#endif /* __cplusplus */

#endif /* __Payment_FWD_DEFINED__ */

#ifdef __StockLevel_FWD_DEFINED__
#define __StockLevel_FWD_DEFINED__

#ifdef __cplusplus
typedef class StockLevel StockLevel;
#else
typedef struct StockLevel StockLevel;
#endif /* __cplusplus */

#endif /* __StockLevel_FWD_DEFINED__ */

/* header files for imported files */
#include "oaidl.h"
#include "ocidl.h"
#include "tpcc_com_ps.h"

#ifdef __cplusplus
```

Appendix A - Application Source Code

```
extern "C"{
#endif

void __RPC_FAR * __RPC_USER MIDL_user_allocate(size_t);
void __RPC_USER MIDL_user_free( void __RPC_FAR * );

/* interface __MIDL_itf_tpcc_com_all_0000 */
/* [local] */

extern RPC_IF_HANDLE __MIDL_itf_tpcc_com_all_0000_v0_0_c_ifspec;
extern RPC_IF_HANDLE __MIDL_itf_tpcc_com_all_0000_v0_0_s_ifspec;

#ifdef __TPCCLib_LIBRARY_DEFINED__
#define __TPCCLib_LIBRARY_DEFINED__

/* library TPCCLib */
/* [helpstring][version][uuid] */

EXTERN_C const IID LIBID_TPCCLib;

EXTERN_C const CLSID CLSID_TPCC;

#ifdef __cplusplus

class DECLSPEC_UUID("122A3128-2520-11D3-BA71-00C04FBFE08B")
TPCC;
#endif

EXTERN_C const CLSID CLSID_NewOrder;

#ifdef __cplusplus

class DECLSPEC_UUID("975BAABF-84A7-11D2-BA47-00C04FBFE08B")
NewOrder;
#endif

EXTERN_C const CLSID CLSID_OrderStatus;

#ifdef __cplusplus

class DECLSPEC_UUID("266836AD-A50D-11D2-BA4E-00C04FBFE08B")
OrderStatus;
#endif

EXTERN_C const CLSID CLSID_Payment;

#ifdef __cplusplus

class DECLSPEC_UUID("CD02F7EF-A4FA-11D2-BA4E-00C04FBFE08B")
Payment;
#endif

EXTERN_C const CLSID CLSID_StockLevel;
```

```
#ifdef __cplusplus

class DECLSPEC_UUID("2668369E-A50D-11D2-BA4E-00C04FBFE08B")
StockLevel;
#endif
#endif /* __TPCCLib_LIBRARY_DEFINED__ */

/* Additional Prototypes for ALL interfaces */

/* end of Additional Prototypes */

#ifdef __cplusplus
}
#endif

#endif
```

tpcc_com_all/src/tpcc_com_all.idl

```
/* FILE: TPCC.IDL
 * Microsoft TPC-C Kit Ver. 4.20.000
 * Copyright Microsoft, 1999
 * All Rights Reserved
 * not yet audited
 * PURPOSE: IDL source for TPCC.dll. This file is processed by the MIDL tool to
 * produce the type library (TPCC.tlb) and
 * marshalling code.
 * Change history:
 * 4.20.000 - first version
 */

interface TPCC;
interface NewOrder;
interface OrderStatus;
interface Payment;
interface StockLevel;

import "oaidl.idl";
import "ocidl.idl";
import "..\tpcc_com_ps\src\tpcc_com_ps.idl";

[
    uuid(122A3117-2520-11D3-BA71-00C04FBFE08B),
    version(1.0),
    helpstring("TPC-C 1.0 Type Library")
]
library TPCCLib
{
    importlib("stdole32.tlb");
    importlib("stdole2.tlb");

    [
        uuid(122A3128-2520-11D3-BA71-00C04FBFE08B),
```

Appendix A - Application Source Code

```
        helpstring("All Txns Class")
    }
    coclass TPCC
    {
        [default] interface ITPCC;
    };

    [
        uuid(975BAABF-84A7-11D2-BA47-00C04FBFE08B),
        helpstring("NewOrder Class")
    ]
    coclass NewOrder
    {
        [default] interface ITPCC;
    };

    [
        uuid(266836AD-A50D-11D2-BA4E-00C04FBFE08B),
        helpstring("OrderStatus Class")
    ]
    coclass OrderStatus
    {
        [default] interface ITPCC;
    };

    [
        uuid(CD02F7EF-A4FA-11D2-BA4E-00C04FBFE08B),
        helpstring("Payment Class")
    ]
    coclass Payment
    {
        [default] interface ITPCC;
    };

    [
        uuid(2668369E-A50D-11D2-BA4E-00C04FBFE08B),
        helpstring("StockLevel Class")
    ]
    coclass StockLevel
    {
        [default] interface ITPCC;
    };
};
```

tpcc_com_all/src/tpcc_com_all.rc

```
//Microsoft Developer Studio generated resource script.
//
#include "resource.h"

#define APSTUDIO_READONLY_SYMBOLS
////////////////////////////////////
//
// Generated from the TEXTINCLUDE 2 resource.
```

```
//
#include "winres.h"

////////////////////////////////////
#undef APSTUDIO_READONLY_SYMBOLS

////////////////////////////////////
// English (U.S.) resources

#if !defined(AFX_RESOURCE_DLL) || defined(AFX_TARG_ENU)
#ifdef _WIN32
LANGUAGE LANG_ENGLISH, SUBLANG_ENGLISH_US
#pragma code_page(1252)
#endif // _WIN32

#ifdef APSTUDIO_INVOKED
////////////////////////////////////
//
// TEXTINCLUDE
//

1 TEXTINCLUDE DISCARDABLE
BEGIN
    "resource.h\0"
END

2 TEXTINCLUDE DISCARDABLE
BEGIN
    "#include \"winres.h\"\r\n"
    "\0"
END

3 TEXTINCLUDE DISCARDABLE
BEGIN
    "1 TYPELIB \"tpcc_com_all.tlb\"\r\n"
    "\0"
END

#endif // APSTUDIO_INVOKED

#ifdef _MAC
////////////////////////////////////
//
// Version
//

VS_VERSION_INFO VERSIONINFO
FILEVERSION 1,0,0,1
PRODUCTVERSION 1,0,0,1
FILEFLAGSMASK 0x3fL
#ifdef _DEBUG
FILEFLAGS 0x1L
#else
FILEFLAGS 0x0L
#endif
FILEOS 0x4L
FILETYPE 0x2L
FILESUBTYPE 0x0L
BEGIN
    BLOCK "StringFileInfo"
    BEGIN
        BLOCK "040904B0"
```

Appendix A - Application Source Code

```
BEGIN
    VALUE "CompanyName", "\0"
    VALUE "FileDescription", "tpcc_com_all Module\0"
    VALUE "FileVersion", "1, 0, 0, 1\0"
    VALUE "InternalName", "TPCCNEWORDER\0"
    VALUE "LegalCopyright", "Copyright 1997\0"
    VALUE "OriginalFilename", "tpcc_com_all.DLL\0"
    VALUE "ProductName", "tpcc_com_all Module\0"
    VALUE "ProductVersion", "1, 0, 0, 1\0"
    VALUE "OLESelfRegister", "\0"
END
END
BLOCK "VarFileInfo"
BEGIN
    VALUE "Translation", 0x409, 1200
END
END

#endif // !_MAC

////////////////////////////////////
//
// REGISTRY
//

IDR_TPCC            REGISTRY DISCARDABLE    "tpcc_com_all.rgs"
IDR_NEWORDER       REGISTRY DISCARDABLE    "tpcc_com_no.rgs"
IDR_ORDERSTATUS    REGISTRY DISCARDABLE    "tpcc_com_os.rgs"
IDR_PAYMENT        REGISTRY DISCARDABLE    "tpcc_com_pay.rgs"
IDR_STOCKLEVEL     REGISTRY DISCARDABLE    "tpcc_com_sl.rgs"

////////////////////////////////////
//
// String Table
//

STRINGTABLE DISCARDABLE
BEGIN
    IDS_PROJNAME        "tpcc_com_all"
END

#endif // English (U.S.) resources
////////////////////////////////////

#ifndef APSTUDIO_INVOKED
////////////////////////////////////
//
// Generated from the TEXTINCLUDE 3 resource.
//
1 TYPELIB "tpcc_com_all.tlb"
////////////////////////////////////
#endif // not APSTUDIO_INVOKED
```

tpcc_com_all/src/tpcc_com_all.rgs

```
HKCR
{
    TPCC.AllTxns.1 = s 'All Txns Class'
    {
        CLSID = s '{122A3128-2520-11D3-BA71-00C04FBFE08B}'
    }
    TPCC.AllTxns = s 'TPCC Class'
    {
        CurVer = s 'TPCC.AllTxns.1'
    }
    NoRemove CLSID
    {
        ForceRemove {122A3128-2520-11D3-BA71-00C04FBFE08B} = s 'TPCC Class'
        {
            ProgID = s 'TPCC.AllTxns.1'
            VersionIndependentProgID = s 'TPCC.AllTxns'
            InprocServer32 = s '%MODULE%'
            {
                val ThreadingModel = s 'Both'
            }
        }
    }
}
```

tpcc_com_all/src/tpcc_com_all_i.c

```
#pragma warning( disable: 4049 ) /* more than 64k source lines */

/* this ALWAYS GENERATED file contains the IIDs and CLSIDs */

/* link this file in with the server and any clients */

/* File created by MIDL compiler version 5.03.0280 */
/* at Sat Apr 08 16:40:18 2000
*/
/* Compiler settings for .\src\tpcc_com_all.idl:
    Oicf (OptLev=i2), Wl, Zp8, env=Win32 (32b run), ms_ext, c_ext
    error checks: allocation ref bounds_check enum stub_data
    VC __declspec() decoration level:
        __declspec(uuid()), __declspec(selectany), __declspec(novtable)
        DECLSPEC_UUID(), MIDL_INTERFACE()
*/
//@@MIDL_FILE_HEADING(  )

#if !defined(_M_IA64) && !defined(_M_AXP64)

#ifdef __cplusplus
extern "C" {
#endif
```

Appendix A - Application Source Code

```
#include <rpc.h>
#include <rpcndr.h>

#ifdef _MIDL_USE_GUIDDEF_

#ifndef INITGUID
#define INITGUID
#include <guiddef.h>
#undef INITGUID
#else
#include <guiddef.h>
#endif

#define MIDL_DEFINE_GUID(type,name,l,w1,w2,b1,b2,b3,b4,b5,b6,b7,b8) \
    DEFINE_GUID(name,l,w1,w2,b1,b2,b3,b4,b5,b6,b7,b8)

#else // !_MIDL_USE_GUIDDEF_

#ifndef __IID_DEFINED__
#define __IID_DEFINED__

typedef struct _IID
{
    unsigned long x;
    unsigned short s1;
    unsigned short s2;
    unsigned char c[8];
} IID;

#endif // __IID_DEFINED__

#ifndef CLSID_DEFINED
#define CLSID_DEFINED
typedef IID CLSID;
#endif // CLSID_DEFINED

#define MIDL_DEFINE_GUID(type,name,l,w1,w2,b1,b2,b3,b4,b5,b6,b7,b8) \
    const type name = {l,w1,w2,{b1,b2,b3,b4,b5,b6,b7,b8}}

#endif !_MIDL_USE_GUIDDEF_

MIDL_DEFINE_GUID(IID,
LIBID_TPCCLib,0x122A3117,0x2520,0x11D3,0xBA,0x71,0x00,0xC0,0x4F,0xBF,0xE0,0x8B);

MIDL_DEFINE_GUID(CLSID,
CLSID_TPCC,0x122A3128,0x2520,0x11D3,0xBA,0x71,0x00,0xC0,0x4F,0xBF,0xE0,0x8B);

MIDL_DEFINE_GUID(CLSID,
CLSID_NewOrder,0x975BAABF,0x84A7,0x11D2,0xBA,0x47,0x00,0xC0,0x4F,0xBF,0xE0,0x8B);

MIDL_DEFINE_GUID(CLSID,
CLSID_OrderStatus,0x266836AD,0xA50D,0x11D2,0xBA,0x4E,0x00,0xC0,0x4F,0xBF,0xE0,0x8B);

MIDL_DEFINE_GUID(CLSID,
CLSID_Payment,0xC02F7EF,0xA4FA,0x11D2,0xBA,0x4E,0x00,0xC0,0x4F,0xBF,0xE0,0x8B);
```

```
MIDL_DEFINE_GUID(CLSID,
CLSID_StockLevel,0x2668369E,0xA50D,0x11D2,0xBA,0x4E,0x00,0xC0,0x4F,0xBF,0xE0,0x8B);

#undef MIDL_DEFINE_GUID

#ifdef __cplusplus
}
#endif

#endif /* !defined(_M_IA64) && !defined(_M_AXP64)*/

#pragma warning( disable: 4049 ) /* more than 64k source lines */

/* this ALWAYS GENERATED file contains the IIDs and CLSIDs */

/* link this file in with the server and any clients */

/* File created by MIDL compiler version 5.03.0280 */
/* at Sat Apr 08 16:40:18 2000 */
/*
 * Compiler settings for .\src\tpcc_com_all.idl:
 * Oicf (OptLev=i2), Wl, Zp8, env=Win64 (32b run,appending), ms_ext, c_ext, robust
 * error checks: allocation ref bounds_check enum stub_data
 * VC __declspec() decoration level:
 *   __declspec(uuid()), __declspec(selectany), __declspec(novtable)
 *   DECLSPEC_UUID(), MIDL_INTERFACE()
 */
//@@MIDL_FILE_HEADING( )

#ifdef _M_IA64 || defined(_M_AXP64)

#ifdef __cplusplus
extern "C" {
#endif

#include <rpc.h>
#include <rpcndr.h>

#ifdef _MIDL_USE_GUIDDEF_

#ifndef INITGUID
#define INITGUID
#include <guiddef.h>
#undef INITGUID
#else
#include <guiddef.h>
#endif

#define MIDL_DEFINE_GUID(type,name,l,w1,w2,b1,b2,b3,b4,b5,b6,b7,b8) \
    DEFINE_GUID(name,l,w1,w2,b1,b2,b3,b4,b5,b6,b7,b8)

#else // !_MIDL_USE_GUIDDEF_

#ifndef __IID_DEFINED__
#define __IID_DEFINED__

typedef struct _IID
{
```

Appendix A - Application Source Code

```
    unsigned long x;
    unsigned short s1;
    unsigned short s2;
    unsigned char c[8];
} IID;
#endif // __IID_DEFINED__

#ifndef CLSID_DEFINED
#define CLSID_DEFINED
typedef IID CLSID;
#endif // CLSID_DEFINED

#define MIDL_DEFINE_GUID(type,name,l,w1,w2,b1,b2,b3,b4,b5,b6,b7,b8) \
    const type name = {l,w1,w2,{b1,b2,b3,b4,b5,b6,b7,b8}}

#endif !_MIDL_USE_GUIDDEF_

MIDL_DEFINE_GUID(IID,
LIBID_TPCCLib,0x122A3117,0x2520,0x11D3,0xBA,0x71,0x00,0xC0,0x4F,0xBF,0xE0,0x8B);

MIDL_DEFINE_GUID(CLSID,
CLSID_TPCC,0x122A3128,0x2520,0x11D3,0xBA,0x71,0x00,0xC0,0x4F,0xBF,0xE0,0x8B);

MIDL_DEFINE_GUID(CLSID,
CLSID_NewOrder,0x975BAABF,0x84A7,0x11D2,0xBA,0x47,0x00,0xC0,0x4F,0xBF,0xE0,0x8B);

MIDL_DEFINE_GUID(CLSID,
CLSID_OrderStatus,0x266836AD,0xA50D,0x11D2,0xBA,0x4E,0x00,0xC0,0x4F,0xBF,0xE0,0x8B);

MIDL_DEFINE_GUID(CLSID,
CLSID_Payment,0xCD02F7EF,0xA4FA,0x11D2,0xBA,0x4E,0x00,0xC0,0x4F,0xBF,0xE0,0x8B);

MIDL_DEFINE_GUID(CLSID,
CLSID_StockLevel,0x2668369E,0xA50D,0x11D2,0xBA,0x4E,0x00,0xC0,0x4F,0xBF,0xE0,0x8B);

#undef MIDL_DEFINE_GUID

#ifdef __cplusplus
}
#endif

#endif /* defined(_M_IA64) || defined(_M_AXP64)*/
```

tpcc_com_all/src/tpcc_com_no.rgs

```
HKCR
```

```
{
    TPCC.NewOrder.1 = s 'NewOrder Class'
    {
        CLSID = s '{975BAABF-84A7-11D2-BA47-00C04FBFE08B}'
    }
    TPCC.NewOrder = s 'NewOrder Class'
    {
        CurVer = s 'TPCC.NewOrder.1'
    }
    NoRemove CLSID
    {
        ForceRemove {975BAABF-84A7-11D2-BA47-00C04FBFE08B} = s 'NewOrder'
    }
}

Class'
{
    ProgID = s 'TPCC.NewOrder.1'
    VersionIndependentProgID = s 'TPCC.NewOrder'
    InprocServer32 = s '%MODULE%'
    {
        val ThreadingModel = s 'Both'
    }
}
}
```

tpcc_com_all/src/tpcc_com_os.rgs

```
HKCR
{
    TPCC.OrderStatus.1 = s 'OrderStatus Class'
    {
        CLSID = s '{266836AD-A50D-11D2-BA4E-00C04FBFE08B}'
    }
    TPCC.OrderStatus = s 'OrderStatus Class'
    {
        CurVer = s 'TPCC.OrderStatus.1'
    }
    NoRemove CLSID
    {
        ForceRemove {266836AD-A50D-11D2-BA4E-00C04FBFE08B} = s 'OrderStatus'
    }
}

Class'
{
    ProgID = s 'TPCC.OrderStatus.1'
    VersionIndependentProgID = s 'TPCC.OrderStatus'
    InprocServer32 = s '%MODULE%'
    {
        val ThreadingModel = s 'Both'
    }
}
}
```

tpcc_com_all/src/tpcc_com_pay.rgs

```
HKCR
{
    TPCC.Payment.1 = s 'Payment Class'
```

Appendix A - Application Source Code

```
{
    CLSID = s '{CD02F7EF-A4FA-11D2-BA4E-00C04FBFE08B}'
}
TPCC.Payment = s 'Payment Class'
{
    CurVer = s 'TPCC.Payment.1'
}
NoRemove CLSID
{
    ForceRemove {CD02F7EF-A4FA-11D2-BA4E-00C04FBFE08B} = s 'Payment
Class'
    {
        ProgID = s 'TPCC.Payment.1'
        VersionIndependentProgID = s 'TPCC.Payment'
        InprocServer32 = s '%MODULE%'
        {
            val ThreadingModel = s 'Both'
        }
    }
}
}
```

tpcc_com_all/src/tpcc_com_ps.h

```
#pragma warning( disable: 4049 ) /* more than 64k source lines */
/* this ALWAYS GENERATED file contains the definitions for the interfaces */

/* File created by MIDL compiler version 5.03.0280 */
/* at Sat Apr 08 16:40:10 2000 */
/*
 * Compiler settings for .\src\tpcc_com_ps.idl:
 * Oicf (OptLev=i2), Wl, Zp8, env=Win32 (32b run), ms_ext, c_ext
 * error checks: allocation ref bounds_check enum stub_data
 * VC __declspec() decoration level:
 *   __declspec(uuid()), __declspec(selectany), __declspec(novtable)
 *   DECLSPEC_UUID(), MIDL_INTERFACE()
 */
//@@MIDL_FILE_HEADING(  )

/* verify that the <rpcndr.h> version is high enough to compile this file*/
#ifdef __REQUIRED_RPCNDR_H_VERSION__
#define __REQUIRED_RPCNDR_H_VERSION__ 440
#endif

#include "rpc.h"
#include "rpcndr.h"

#ifdef __RPCNDR_H_VERSION__
#error this stub requires an updated version of <rpcndr.h>
#endif // __RPCNDR_H_VERSION__

#ifdef COM_NO_WINDOWS_H
#include "windows.h"

```

```
#include "ole2.h"
#endif /*COM_NO_WINDOWS_H*/

#ifdef __tpcc_com_ps_h__
#define __tpcc_com_ps_h__

/* Forward Declarations */

#ifdef __ITPCC_FWD_DEFINED__
#define __ITPCC_FWD_DEFINED__
typedef interface ITPCC ITPCC;
#endif /* __ITPCC_FWD_DEFINED__ */

/* header files for imported files */
#include "oaidl.h"
#include "ocidl.h"

#ifdef __cplusplus
extern "C"{
#endif

void __RPC_FAR * __RPC_USER MIDL_user_allocate(size_t);
void __RPC_USER MIDL_user_free( void __RPC_FAR * );

/* interface __MIDL_itf_tpcc_com_ps_0000 */
/* [local] */

extern RPC_IF_HANDLE __MIDL_itf_tpcc_com_ps_0000_v0_0_c_ifspec;
extern RPC_IF_HANDLE __MIDL_itf_tpcc_com_ps_0000_v0_0_s_ifspec;

#ifdef __ITPCC_INTERFACE_DEFINED__
#define __ITPCC_INTERFACE_DEFINED__

/* interface ITPCC */
/* [unique][helpstring][uuid][oleautomation][object] */

EXTERN_C const IID IID_ITPCC;

#ifdef __cplusplus && !defined(CINTERFACE)

MIDL_INTERFACE("FEEE6AA2-84B1-11d2-BA47-00C04FBFE08B")
ITPCC : public IUnknown
{
public:
    virtual HRESULT STDMETHODCALLTYPE NewOrder(
        /* [in] */ VARIANT txn_in,
        /* [out] */ VARIANT __RPC_FAR *txn_out) = 0;

    virtual HRESULT STDMETHODCALLTYPE Payment(
        /* [in] */ VARIANT txn_in,
        /* [out] */ VARIANT __RPC_FAR *txn_out) = 0;

    virtual HRESULT STDMETHODCALLTYPE Delivery(
        /* [in] */ VARIANT txn_in,
        /* [out] */ VARIANT __RPC_FAR *txn_out) = 0;

    virtual HRESULT STDMETHODCALLTYPE StockLevel(
        /* [in] */ VARIANT txn_in,

```

Appendix A - Application Source Code

```
    /* [out] */ VARIANT __RPC_FAR *txn_out) = 0;

virtual HRESULT __stdcall OrderStatus(
    /* [in] */ VARIANT txn_in,
    /* [out] */ VARIANT __RPC_FAR *txn_out) = 0;

virtual HRESULT __stdcall CallSetComplete( void) = 0;
};

#else /* C style interface */

typedef struct ITPCCVtbl
{
    BEGIN_INTERFACE

    HRESULT ( STDMETHODCALLTYPE __RPC_FAR *QueryInterface )(
        ITPCC __RPC_FAR * This,
        /* [in] */ REFIID riid,
        /* [iid_is][out] */ void __RPC_FAR *__RPC_FAR *ppvObject);

    ULONG ( STDMETHODCALLTYPE __RPC_FAR *AddRef )(
        ITPCC __RPC_FAR * This);

    ULONG ( STDMETHODCALLTYPE __RPC_FAR *Release )(
        ITPCC __RPC_FAR * This);

    HRESULT ( STDMETHODCALLTYPE __RPC_FAR *NewOrder )(
        ITPCC __RPC_FAR * This,
        /* [in] */ VARIANT txn_in,
        /* [out] */ VARIANT __RPC_FAR *txn_out);

    HRESULT ( STDMETHODCALLTYPE __RPC_FAR *Payment )(
        ITPCC __RPC_FAR * This,
        /* [in] */ VARIANT txn_in,
        /* [out] */ VARIANT __RPC_FAR *txn_out);

    HRESULT ( STDMETHODCALLTYPE __RPC_FAR *Delivery )(
        ITPCC __RPC_FAR * This,
        /* [in] */ VARIANT txn_in,
        /* [out] */ VARIANT __RPC_FAR *txn_out);

    HRESULT ( STDMETHODCALLTYPE __RPC_FAR *StockLevel )(
        ITPCC __RPC_FAR * This,
        /* [in] */ VARIANT txn_in,
        /* [out] */ VARIANT __RPC_FAR *txn_out);

    HRESULT ( STDMETHODCALLTYPE __RPC_FAR *OrderStatus )(
        ITPCC __RPC_FAR * This,
        /* [in] */ VARIANT txn_in,
        /* [out] */ VARIANT __RPC_FAR *txn_out);

    HRESULT ( STDMETHODCALLTYPE __RPC_FAR *CallSetComplete )(
        ITPCC __RPC_FAR * This);

    END_INTERFACE
} ITPCCVtbl;

interface ITPCC
{
    CONST_VTBL struct ITPCCVtbl __RPC_FAR *lpVtbl;
};
```

```
#ifdef COBJMACROS

#define ITPCC_QueryInterface(This,riid,ppvObject)\
    (This->lpVtbl -> QueryInterface(This,riid,ppvObject))

#define ITPCC_AddRef(This) \
    (This->lpVtbl -> AddRef(This))

#define ITPCC_Release(This) \
    (This->lpVtbl -> Release(This))

#define ITPCC_NewOrder(This,txn_in,txn_out) \
    (This->lpVtbl -> NewOrder(This,txn_in,txn_out))

#define ITPCC_Payment(This,txn_in,txn_out) \
    (This->lpVtbl -> Payment(This,txn_in,txn_out))

#define ITPCC_Delivery(This,txn_in,txn_out) \
    (This->lpVtbl -> Delivery(This,txn_in,txn_out))

#define ITPCC_StockLevel(This,txn_in,txn_out) \
    (This->lpVtbl -> StockLevel(This,txn_in,txn_out))

#define ITPCC_OrderStatus(This,txn_in,txn_out) \
    (This->lpVtbl -> OrderStatus(This,txn_in,txn_out))

#define ITPCC_CallSetComplete(This) \
    (This->lpVtbl -> CallSetComplete(This))

#endif /* COBJMACROS */

#endif /* C style interface */

HRESULT __stdcall ITPCC_NewOrder_Proxy(
    ITPCC __RPC_FAR * This,
    /* [in] */ VARIANT txn_in,
    /* [out] */ VARIANT __RPC_FAR *txn_out);

void __RPC_STUB ITPCC_NewOrder_Stub(
    IRpcStubBuffer *This,
    IRpcChannelBuffer *pRpcChannelBuffer,
    PRPC_MESSAGE _pRpcMessage,
    DWORD *_pdwStubPhase);

HRESULT __stdcall ITPCC_Payment_Proxy(
    ITPCC __RPC_FAR * This,
    /* [in] */ VARIANT txn_in,
    /* [out] */ VARIANT __RPC_FAR *txn_out);

void __RPC_STUB ITPCC_Payment_Stub(
    IRpcStubBuffer *This,
    IRpcChannelBuffer *pRpcChannelBuffer,
    PRPC_MESSAGE _pRpcMessage,
```

Appendix A - Application Source Code

```
DWORD *_pdwStubPhase);

HRESULT __stdcall ITPCC_Delivery_Proxy(
    ITPCC __RPC_FAR * This,
    /* [in] */ VARIANT txn_in,
    /* [out] */ VARIANT __RPC_FAR *txn_out);

void __RPC_STUB ITPCC_Delivery_Stub(
    IRpcStubBuffer *This,
    IRpcChannelBuffer *_pRpcChannelBuffer,
    PRPC_MESSAGE _pRpcMessage,
    DWORD *_pdwStubPhase);

HRESULT __stdcall ITPCC_StockLevel_Proxy(
    ITPCC __RPC_FAR * This,
    /* [in] */ VARIANT txn_in,
    /* [out] */ VARIANT __RPC_FAR *txn_out);

void __RPC_STUB ITPCC_StockLevel_Stub(
    IRpcStubBuffer *This,
    IRpcChannelBuffer *_pRpcChannelBuffer,
    PRPC_MESSAGE _pRpcMessage,
    DWORD *_pdwStubPhase);

HRESULT __stdcall ITPCC_OrderStatus_Proxy(
    ITPCC __RPC_FAR * This,
    /* [in] */ VARIANT txn_in,
    /* [out] */ VARIANT __RPC_FAR *txn_out);

void __RPC_STUB ITPCC_OrderStatus_Stub(
    IRpcStubBuffer *This,
    IRpcChannelBuffer *_pRpcChannelBuffer,
    PRPC_MESSAGE _pRpcMessage,
    DWORD *_pdwStubPhase);

HRESULT __stdcall ITPCC_CallSetComplete_Proxy(
    ITPCC __RPC_FAR * This);

void __RPC_STUB ITPCC_CallSetComplete_Stub(
    IRpcStubBuffer *This,
    IRpcChannelBuffer *_pRpcChannelBuffer,
    PRPC_MESSAGE _pRpcMessage,
    DWORD *_pdwStubPhase);

#endif /* __ITPCC_INTERFACE_DEFINED__ */

/* Additional Prototypes for ALL interfaces */

unsigned long             __RPC_USER  VARIANT_UserSize(      unsigned long __RPC_FAR *,
unsigned long             , VARIANT __RPC_FAR * );
unsigned char __RPC_FAR * __RPC_USER  VARIANT_UserMarshal(  unsigned long __RPC_FAR *,
unsigned char __RPC_FAR *, VARIANT __RPC_FAR * );
```

```
unsigned char __RPC_FAR * __RPC_USER  VARIANT_UserUnmarshal(unsigned long __RPC_FAR *,
unsigned char __RPC_FAR *, VARIANT __RPC_FAR * );
void __RPC_USER  VARIANT_UserFree(      unsigned long __RPC_FAR *,
VARIANT __RPC_FAR * );

/* end of Additional Prototypes */

#ifdef __cplusplus
}
#endif

#endif
```

tpcc_com_all/src/tpcc_com_sl.rgs

```
HKCR
{
    TPCC.StockLevel.1 = s 'StockLevel Class'
    {
        CLSID = s '{2668369E-A50D-11D2-BA4E-00C04FBFE08B}'
    }
    TPCC.StockLevel = s 'StockLevel Class'
    {
        CurVer = s 'TPCC.StockLevel.1'
    }
    NoRemove CLSID
    {
        ForceRemove {2668369E-A50D-11D2-BA4E-00C04FBFE08B} = s 'StockLevel
Class'
    {
        ProgID = s 'TPCC.StockLevel.1'
        VersionIndependentProgID = s 'TPCC.StockLevel'
        InprocServer32 = s '%MODULE%'
        {
            val ThreadingModel = s 'Both'
        }
    }
    }
}
```

tpcc_com_ps/src/dlldata.c

```
/*
*****
DllData file -- generated by MIDL compiler

DO NOT ALTER THIS FILE

This file is regenerated by MIDL on every IDL file compile.

To completely reconstruct this file, delete it and rerun MIDL
on all the IDL files in this DLL, specifying this file for the
```

Appendix A - Application Source Code

```
    /dlldata command line option
*****
#include <rpcproxy.h>

#ifdef __cplusplus
extern "C" {
#endif

EXTERN_PROXY_FILE( tpcc_com_ps )

PROXYFILE_LIST_START
/* Start of list */
REFERENCE_PROXY_FILE( tpcc_com_ps ),
/* End of list */
PROXYFILE_LIST_END

DLLDATA_ROUTINES( aProxyFileList, GET_DLL_CLSID )

#ifdef __cplusplus
} /*extern "C" */
#endif

/* end of generated dlldata file */
```

tpcc_com_ps/src/tpcc_com_ps.def

```
LIBRARY      "tpcc_com_ps"

DESCRIPTION  'Proxy/Stub DLL'

EXPORTS
    DllGetClassObject      @1 PRIVATE
    DllCanUnloadNow        @2 PRIVATE
    GetProxyDllInfo        @3 PRIVATE
    DllRegisterServer      @4 PRIVATE PRIVATE
    DllUnregisterServer    @5 PRIVATE PRIVATE
```

tpcc_com_ps/src/tpcc_com_ps.h

```
#pragma warning( disable: 4049 ) /* more than 64k source lines */

/* this ALWAYS GENERATED file contains the definitions for the interfaces */

/* File created by MIDL compiler version 5.03.0280 */
/* at Sat Apr 08 16:40:10 2000
*/
```

```
/* Compiler settings for .\src\tpcc_com_ps.idl:
Oicf (OptLev=i2), Wl, Zp8, env=Win32 (32b run), ms_ext, c_ext
error checks: allocation ref bounds_check enum stub_data
VC __declspec() decoration level:
    __declspec(uuid()), __declspec(selectany), __declspec(novtable)
DECLSPEC_UUID(), MIDL_INTERFACE()
*/
//@@MIDL_FILE_HEADING(  )

/* verify that the <rpcndr.h> version is high enough to compile this file*/
#ifdef __REQUIRED_RPCNDR_H_VERSION__
#define __REQUIRED_RPCNDR_H_VERSION__ 440
#endif

#include "rpc.h"
#include "rpcndr.h"

#ifdef __RPCNDR_H_VERSION__
#error this stub requires an updated version of <rpcndr.h>
#endif // __RPCNDR_H_VERSION__

#ifdef COM_NO_WINDOWS_H
#include "windows.h"
#include "ole2.h"
#endif /*COM_NO_WINDOWS_H*/

#ifdef __tpcc_com_ps_h__
#define __tpcc_com_ps_h__

/* Forward Declarations */

#ifdef __ITPCC_FWD_DEFINED__
#define __ITPCC_FWD_DEFINED__
typedef interface ITPCC ITPCC;
#endif /* __ITPCC_FWD_DEFINED__ */

/* header files for imported files */
#include "oaidl.h"
#include "ocidl.h"

#ifdef __cplusplus
extern "C"{
#endif

void __RPC_FAR * __RPC_USER MIDL_user_allocate(size_t);
void __RPC_USER MIDL_user_free( void __RPC_FAR * );

/* interface __MIDL_itf_tpcc_com_ps_0000 */
/* [local] */

extern RPC_IF_HANDLE __MIDL_itf_tpcc_com_ps_0000_v0_0_c_ifspec;
extern RPC_IF_HANDLE __MIDL_itf_tpcc_com_ps_0000_v0_0_s_ifspec;

#ifdef __ITPCC_INTERFACE_DEFINED__
#define __ITPCC_INTERFACE_DEFINED__

/* interface ITPCC */
/* [unique][helpstring][uuid][oleautomation][object] */
```

Appendix A - Application Source Code

```
EXTERN_C const IID IID_ITPCC;

#if defined(__cplusplus) && !defined(CINTERFACE)

MIDL_INTERFACE("FEEE6AA2-84B1-11d2-BA47-00C04FBFE08B")
ITPCC : public IUnknown
{
public:
    virtual HRESULT STDMETHODCALLTYPE NewOrder(
        /* [in] */ VARIANT txn_in,
        /* [out] */ VARIANT __RPC_FAR *txn_out) = 0;

    virtual HRESULT STDMETHODCALLTYPE Payment(
        /* [in] */ VARIANT txn_in,
        /* [out] */ VARIANT __RPC_FAR *txn_out) = 0;

    virtual HRESULT STDMETHODCALLTYPE Delivery(
        /* [in] */ VARIANT txn_in,
        /* [out] */ VARIANT __RPC_FAR *txn_out) = 0;

    virtual HRESULT STDMETHODCALLTYPE StockLevel(
        /* [in] */ VARIANT txn_in,
        /* [out] */ VARIANT __RPC_FAR *txn_out) = 0;

    virtual HRESULT STDMETHODCALLTYPE OrderStatus(
        /* [in] */ VARIANT txn_in,
        /* [out] */ VARIANT __RPC_FAR *txn_out) = 0;

    virtual HRESULT STDMETHODCALLTYPE CallSetComplete( void) = 0;

};

#else /* C style interface */

typedef struct ITPCCVtbl
{
    BEGIN_INTERFACE

    HRESULT ( STDMETHODCALLTYPE *QueryInterface )(
        ITPCC __RPC_FAR * This,
        /* [in] */ REFIID riid,
        /* [iid_is][out] */ void __RPC_FAR * __RPC_FAR *ppvObject);

    ULONG ( STDMETHODCALLTYPE *AddRef )(
        ITPCC __RPC_FAR * This);

    ULONG ( STDMETHODCALLTYPE *Release )(
        ITPCC __RPC_FAR * This);

    HRESULT ( STDMETHODCALLTYPE *NewOrder )(
        ITPCC __RPC_FAR * This,
        /* [in] */ VARIANT txn_in,
        /* [out] */ VARIANT __RPC_FAR *txn_out);

    HRESULT ( STDMETHODCALLTYPE *Payment )(
        ITPCC __RPC_FAR * This,
        /* [in] */ VARIANT txn_in,
        /* [out] */ VARIANT __RPC_FAR *txn_out);

    HRESULT ( STDMETHODCALLTYPE *Delivery )(
        ITPCC __RPC_FAR * This,
```

```
        /* [in] */ VARIANT txn_in,
        /* [out] */ VARIANT __RPC_FAR *txn_out);

    HRESULT ( STDMETHODCALLTYPE *StockLevel )(
        ITPCC __RPC_FAR * This,
        /* [in] */ VARIANT txn_in,
        /* [out] */ VARIANT __RPC_FAR *txn_out);

    HRESULT ( STDMETHODCALLTYPE *OrderStatus )(
        ITPCC __RPC_FAR * This,
        /* [in] */ VARIANT txn_in,
        /* [out] */ VARIANT __RPC_FAR *txn_out);

    HRESULT ( STDMETHODCALLTYPE *CallSetComplete )(
        ITPCC __RPC_FAR * This);

    END_INTERFACE
} ITPCCVtbl;

interface ITPCC
{
    CONST_VTBL struct ITPCCVtbl __RPC_FAR *lpVtbl;
};

#ifdef COBJMACROS

#define ITPCC_QueryInterface(This,riid,ppvObject)\
    (This->lpVtbl -> QueryInterface(This,riid,ppvObject))

#define ITPCC_AddRef(This) \
    (This->lpVtbl -> AddRef(This))

#define ITPCC_Release(This) \
    (This->lpVtbl -> Release(This))

#define ITPCC_NewOrder(This,txn_in,txn_out) \
    (This->lpVtbl -> NewOrder(This,txn_in,txn_out))

#define ITPCC_Payment(This,txn_in,txn_out) \
    (This->lpVtbl -> Payment(This,txn_in,txn_out))

#define ITPCC_Delivery(This,txn_in,txn_out) \
    (This->lpVtbl -> Delivery(This,txn_in,txn_out))

#define ITPCC_StockLevel(This,txn_in,txn_out) \
    (This->lpVtbl -> StockLevel(This,txn_in,txn_out))

#define ITPCC_OrderStatus(This,txn_in,txn_out) \
    (This->lpVtbl -> OrderStatus(This,txn_in,txn_out))

#define ITPCC_CallSetComplete(This) \
    (This->lpVtbl -> CallSetComplete(This))

#endif /* COBJMACROS */

#endif /* C style interface */
```

Appendix A - Application Source Code

```
HRESULT __stdcall ITPCC_NewOrder_Proxy(
    ITPCC __RPC_FAR * This,
    /* [in] */ VARIANT txn_in,
    /* [out] */ VARIANT __RPC_FAR *txn_out);

void __RPC_STUB ITPCC_NewOrder_Stub(
    IRpcStubBuffer *This,
    IRpcChannelBuffer *pRpcChannelBuffer,
    PRPC_MESSAGE pRpcMessage,
    DWORD *_pdwStubPhase);

HRESULT __stdcall ITPCC_Payment_Proxy(
    ITPCC __RPC_FAR * This,
    /* [in] */ VARIANT txn_in,
    /* [out] */ VARIANT __RPC_FAR *txn_out);

void __RPC_STUB ITPCC_Payment_Stub(
    IRpcStubBuffer *This,
    IRpcChannelBuffer *pRpcChannelBuffer,
    PRPC_MESSAGE pRpcMessage,
    DWORD *_pdwStubPhase);

HRESULT __stdcall ITPCC_Delivery_Proxy(
    ITPCC __RPC_FAR * This,
    /* [in] */ VARIANT txn_in,
    /* [out] */ VARIANT __RPC_FAR *txn_out);

void __RPC_STUB ITPCC_Delivery_Stub(
    IRpcStubBuffer *This,
    IRpcChannelBuffer *pRpcChannelBuffer,
    PRPC_MESSAGE pRpcMessage,
    DWORD *_pdwStubPhase);

HRESULT __stdcall ITPCC_StockLevel_Proxy(
    ITPCC __RPC_FAR * This,
    /* [in] */ VARIANT txn_in,
    /* [out] */ VARIANT __RPC_FAR *txn_out);

void __RPC_STUB ITPCC_StockLevel_Stub(
    IRpcStubBuffer *This,
    IRpcChannelBuffer *pRpcChannelBuffer,
    PRPC_MESSAGE pRpcMessage,
    DWORD *_pdwStubPhase);

HRESULT __stdcall ITPCC_OrderStatus_Proxy(
    ITPCC __RPC_FAR * This,
    /* [in] */ VARIANT txn_in,
    /* [out] */ VARIANT __RPC_FAR *txn_out);

void __RPC_STUB ITPCC_OrderStatus_Stub(
    IRpcStubBuffer *This,
    IRpcChannelBuffer *pRpcChannelBuffer,
    PRPC_MESSAGE pRpcMessage,
```

```
DWORD *_pdwStubPhase);

HRESULT __stdcall ITPCC_CallSetComplete_Proxy(
    ITPCC __RPC_FAR * This);

void __RPC_STUB ITPCC_CallSetComplete_Stub(
    IRpcStubBuffer *This,
    IRpcChannelBuffer *pRpcChannelBuffer,
    PRPC_MESSAGE pRpcMessage,
    DWORD *_pdwStubPhase);

#endif /* __ITPCC_INTERFACE_DEFINED__ */

/* Additional Prototypes for ALL interfaces */

unsigned long             __RPC_USER  VARIANT_UserSize(      unsigned long __RPC_FAR *,
unsigned long             , VARIANT __RPC_FAR * );
unsigned char __RPC_FAR * __RPC_USER  VARIANT_UserMarshal(  unsigned long __RPC_FAR *,
unsigned char __RPC_FAR *, VARIANT __RPC_FAR * );
unsigned char __RPC_FAR * __RPC_USER  VARIANT_UserUnmarshal(unsigned long __RPC_FAR *,
unsigned char __RPC_FAR *, VARIANT __RPC_FAR * );
void                    __RPC_USER  VARIANT_UserFree(      unsigned long __RPC_FAR *,
VARIANT __RPC_FAR * );

/* end of Additional Prototypes */

#ifdef __cplusplus
}
#endif
#endif
```

tpcc_com_ps/src/tpcc_com_ps.idl

```
/*      FILE:          ITPCC.IDL
 *
 *                      Microsoft TPC-C Kit Ver. 4.20.000
 *                      Copyright Microsoft, 1999
 *
 *                      All Rights Reserved
 *
 *
 *                      not yet audited
 *
 *
 *      PURPOSE:       Defines the interface used by TPCC. This
interface can be implemented by C++ components.
 *
 *      Change history:
 *
 *                      4.20.000 - first version
```

Appendix A - Application Source Code

```
*/
// Forward declare all types defined
interface ITPCC;
import "oaidl.idl";
import "ocidl.idl";

[
    object,
    oleautomation,
    uuid(FEEE6AA2-84B1-11d2-BA47-00C04FBFE08B),
    helpstring("ITPCC Interface"),
    pointer_default(unique)
]
interface ITPCC : IUnknown
{
    HRESULT STDMETHODCALLTYPE NewOrder
        (
            [in] VARIANT txn_in,
            [out] VARIANT *txn_out
        );

    HRESULT STDMETHODCALLTYPE Payment
        (
            [in] VARIANT txn_in,
            [out] VARIANT *txn_out
        );

    HRESULT STDMETHODCALLTYPE Delivery
        (
            [in] VARIANT txn_in,
            [out] VARIANT *txn_out
        );

    HRESULT STDMETHODCALLTYPE StockLevel
        (
            [in] VARIANT txn_in,
            [out] VARIANT *txn_out
        );

    HRESULT STDMETHODCALLTYPE OrderStatus
        (
            [in] VARIANT txn_in,
            [out] VARIANT *txn_out
        );
}
```

```
HRESULT STDMETHODCALLTYPE CallSetComplete
    (
    );

}; // interface ITPCC
```

tpcc_com_ps/src/tpcc_com_ps_i.c

```
#pragma warning( disable: 4049 ) /* more than 64k source lines */
/* this ALWAYS GENERATED file contains the IIDs and CLSIDs */
/* link this file in with the server and any clients */

/* File created by MIDL compiler version 5.03.0280 */
/* at Sat Apr 08 16:40:10 2000
*/
/* Compiler settings for .\src\tpcc_com_ps.idl:
    Oicf (OptLev=i2), Wl, Zp8, env=Win32 (32b run), ms_ext, c_ext
    error checks: allocation ref bounds_check enum stub_data
    VC __declspec() decoration level:
        __declspec(uuid()), __declspec(selectany), __declspec(novtable)
        DECLSPEC_UUID(), MIDL_INTERFACE()
*/
//@@MIDL_FILE_HEADING(  )

#if !defined(_M_IA64) && !defined(_M_AXP64)

#ifdef __cplusplus
extern "C"{
#endif

#include <rpc.h>
#include <rpcndr.h>

#ifdef _MIDL_USE_GUIDDEF_

#ifndef INITGUID
#define INITGUID
#include <guiddef.h>
#undef INITGUID
#else
#include <guiddef.h>
#endif

#define MIDL_DEFINE_GUID(type,name,l,w1,w2,b1,b2,b3,b4,b5,b6,b7,b8) \
    DEFINE_GUID(name,l,w1,w2,b1,b2,b3,b4,b5,b6,b7,b8)

#else // !_MIDL_USE_GUIDDEF_
```

Appendix A - Application Source Code

```
#ifndef __IID_DEFINED__
#define __IID_DEFINED__

typedef struct _IID
{
    unsigned long x;
    unsigned short s1;
    unsigned short s2;
    unsigned char c[8];
} IID;

#endif // __IID_DEFINED__

#ifndef CLSID_DEFINED
#define CLSID_DEFINED
typedef IID CLSID;
#endif // CLSID_DEFINED

#define MIDL_DEFINE_GUID(type,name,l,w1,w2,b1,b2,b3,b4,b5,b6,b7,b8) \
    const type name = {l,w1,w2,{b1,b2,b3,b4,b5,b6,b7,b8}}

#endif !_MIDL_USE_GUIDDEF_

MIDL_DEFINE_GUID(IID,
IID_ITPCC,0xFEEE6AA2,0x84B1,0x11d2,0xBA,0x47,0x00,0xC0,0x4F,0xBF,0xE0,0x8B);

#undef MIDL_DEFINE_GUID

#ifdef __cplusplus
}
#endif

#endif /* !defined(_M_IA64) && !defined(_M_AXP64)*/

#pragma warning( disable: 4049 ) /* more than 64k source lines */

/* this ALWAYS GENERATED file contains the IIDs and CLSIDs */

/* link this file in with the server and any clients */

/* File created by MIDL compiler version 5.03.0280 */
/* at Sat Apr 08 16:40:10 2000 */
/*
/* Compiler settings for .\src\tpcc_com_ps.idl:
    Oicf (OptLev=i2), Wl, Zp8, env=Win64 (32b run,appending), ms_ext, c_ext, robust
    error checks: allocation ref bounds_check enum stub_data
    VC __declspec() decoration level:
        __declspec(uuid()), __declspec(selectany), __declspec(novtable)
        DECLSPEC_UUID(), MIDL_INTERFACE()
*/
//@@MIDL_FILE_HEADING( )

#ifdef defined(_M_IA64) || defined(_M_AXP64)

#ifdef __cplusplus
extern "C"{
#endif
#endif
```

```
#include <rpc.h>
#include <rpcndr.h>

#ifdef _MIDL_USE_GUIDDEF_

#ifndef INITGUID
#define INITGUID
#include <guiddef.h>
#undef INITGUID
#else
#include <guiddef.h>
#endif

#define MIDL_DEFINE_GUID(type,name,l,w1,w2,b1,b2,b3,b4,b5,b6,b7,b8) \
    DEFINE_GUID(name,l,w1,w2,b1,b2,b3,b4,b5,b6,b7,b8)

#else // !_MIDL_USE_GUIDDEF_

#ifndef __IID_DEFINED__
#define __IID_DEFINED__

typedef struct _IID
{
    unsigned long x;
    unsigned short s1;
    unsigned short s2;
    unsigned char c[8];
} IID;

#endif // __IID_DEFINED__

#ifndef CLSID_DEFINED
#define CLSID_DEFINED
typedef IID CLSID;
#endif // CLSID_DEFINED

#define MIDL_DEFINE_GUID(type,name,l,w1,w2,b1,b2,b3,b4,b5,b6,b7,b8) \
    const type name = {l,w1,w2,{b1,b2,b3,b4,b5,b6,b7,b8}}

#endif !_MIDL_USE_GUIDDEF_

MIDL_DEFINE_GUID(IID,
IID_ITPCC,0xFEEE6AA2,0x84B1,0x11d2,0xBA,0x47,0x00,0xC0,0x4F,0xBF,0xE0,0x8B);

#undef MIDL_DEFINE_GUID

#ifdef __cplusplus
}
#endif

#endif /* defined(_M_IA64) || defined(_M_AXP64)*/
```

tpcc_com_ps/src/tpcc_com_ps_p.c

Appendix A - Application Source Code

```
#pragma warning( disable: 4049 ) /* more than 64k source lines */

/* this ALWAYS GENERATED file contains the proxy stub code */

/* File created by MIDL compiler version 5.03.0280 */
/* at Sat Apr 08 16:40:10 2000
*/
/* Compiler settings for .\src\tpcc_com_ps.idl:
   Oicf (OptLev=i2), Wl, Zp8, env=Win32 (32b run), ms_ext, c_ext
   error checks: allocation ref bounds_check enum stub_data
   VC __declspec() decoration level:
       __declspec(uuid()), __declspec(selectany), __declspec(novtable)
   DECLSPEC_UUID(), MIDL_INTERFACE()
*/
//@@MIDL_FILE_HEADING(  )

#if !defined(_M_IA64) && !defined(_M_AXP64)
#define USE_STUBLESS_PROXY

/* verify that the <rpcproxy.h> version is high enough to compile this file*/
#ifndef __REQD_RPCPROXY_H_VERSION__
#define __REQUIRED_RPCPROXY_H_VERSION__ 440
#endif

#include "rpcproxy.h"
#ifndef __RPCPROXY_H_VERSION__
#error this stub requires an updated version of <rpcproxy.h>
#endif // __RPCPROXY_H_VERSION__

#include "tpcc_com_ps.h"

#define TYPE_FORMAT_STRING_SIZE 997
#define PROC_FORMAT_STRING_SIZE 193
#define TRANSMIT_AS_TABLE_SIZE 0
#define WIRE_MARSHAL_TABLE_SIZE 1

typedef struct _MIDL_TYPE_FORMAT_STRING
{
    short          Pad;
    unsigned char  Format[ TYPE_FORMAT_STRING_SIZE ];
} MIDL_TYPE_FORMAT_STRING;

typedef struct _MIDL_PROC_FORMAT_STRING
{
    short          Pad;
    unsigned char  Format[ PROC_FORMAT_STRING_SIZE ];
} MIDL_PROC_FORMAT_STRING;

extern const MIDL_TYPE_FORMAT_STRING __MIDL_TypeFormatString;
extern const MIDL_PROC_FORMAT_STRING __MIDL_ProcFormatString;

/* Standard interface: __MIDL_itf_tpcc_com_ps_0000, ver. 0.0,
   GUID={0x00000000,0x0000,0x0000,{0x00,0x00,0x00,0x00,0x00,0x00,0x00,0x00}} */

/* Object interface: IUnknown, ver. 0.0,
   GUID={0x00000000,0x0000,0x0000,{0xC0,0x00,0x00,0x00,0x00,0x00,0x00,0x46}} */

/* Object interface: ITPCC, ver. 0.0,
   GUID={0xFEE6AA2,0x84B1,0x11d2,{0xBA,0x47,0x00,0xC0,0x4F,0xBF,0xE0,0x8B}} */

extern const MIDL_STUB_DESC Object_StubDesc;

extern const MIDL_SERVER_INFO ITPCC_ServerInfo;

#pragma code_seg(".orpc")
static const unsigned short ITPCC_FormatStringOffsetTable[] =
{
    0,
    34,
    68,
    102,
    136,
    170
};

static const MIDL_SERVER_INFO ITPCC_ServerInfo =
{
    &Object_StubDesc,
    0,
    __MIDL_ProcFormatString.Format,
    &ITPCC_FormatStringOffsetTable[-3],
    0,
    0,
    0,
    0
};

static const MIDL_STUBLESS_PROXY_INFO ITPCC_ProxyInfo =
{
    &Object_StubDesc,
    __MIDL_ProcFormatString.Format,
    &ITPCC_FormatStringOffsetTable[-3],
    0,
    0,
    0
};

CINTERFACE_PROXY_VTABLE(9) _ITPCCProxyVtbl =
{
    &ITPCC_ProxyInfo,
    &IID_ITPCC,
    IUnknown_QueryInterface_Proxy,
    IUnknown_AddRef_Proxy,
    IUnknown_Release_Proxy ,
    (void *)-1 /* ITPCC::NewOrder */ ,
    (void *)-1 /* ITPCC::Payment */ ,
    (void *)-1 /* ITPCC::Delivery */ ,
    (void *)-1 /* ITPCC::StockLevel */ ,
    (void *)-1 /* ITPCC::OrderStatus */ ,
    (void *)-1 /* ITPCC::CallSetComplete */
};

const CInterfaceStubVtbl _ITPCCStubVtbl =
{

```

Appendix A - Application Source Code

```

                                NdrFcShort( 0x18 ),/* Alpha Stack size/offset = 24 */
#endif
/* 26 */ NdrFcShort( 0x3da ),          /* Type Offset=986 */

    /* Return value */

/* 28 */ NdrFcShort( 0x70 ),/* Flags: out, return, base type, */
#ifndef _ALPHA_
#ifndef _PPC_
#if !defined(_MIPS_)
/* 30 */ NdrFcShort( 0x18 ),/* x86 Stack size/offset = 24 */
#else
                                NdrFcShort( 0x1c ),/* MIPS Stack size/offset = 28 */
#endif
#else
                                NdrFcShort( 0x1c ),/* PPC Stack size/offset = 28 */
#endif
#else
                                NdrFcShort( 0x20 ),/* Alpha Stack size/offset = 32 */
#endif
/* 32 */ 0x8,
          /* FC_LONG */
          0x0,
          /* 0 */

    /* Procedure Payment */

/* 34 */ 0x33,
          /* FC_AUTO_HANDLE */
          0x6c,
          /* Old Flags: object, Oi2 */

/* 36 */ NdrFcLong( 0x0 ), /* 0 */
/* 40 */ NdrFcShort( 0x4 ), /* 4 */
#ifndef _ALPHA_
#ifndef _PPC_
#if !defined(_MIPS_)
/* 42 */ NdrFcShort( 0x1c ),/* x86 Stack size/offset = 28 */
#else
                                NdrFcShort( 0x20 ),/* MIPS Stack size/offset = 32 */
#endif
#else
                                NdrFcShort( 0x20 ),/* PPC Stack size/offset = 32 */
#endif
#else
                                NdrFcShort( 0x28 ),/* Alpha Stack size/offset = 40 */
#endif
/* 44 */ NdrFcShort( 0x0 ), /* 0 */
/* 46 */ NdrFcShort( 0x8 ), /* 8 */
/* 48 */ 0x7,
          /* Oi2 Flags: srv must size, clt must size, has return, */
          0x3,
          /* 3 */

    /* Parameter txn_in */

/* 50 */ NdrFcShort( 0x8b ),/* Flags: must size, must free, in, by val, */
#ifndef _ALPHA_
#ifndef _PPC_
#if !defined(_MIPS_)
/* 52 */ NdrFcShort( 0x4 ), /* x86 Stack size/offset = 4 */
#else
                                NdrFcShort( 0x8 ), /* MIPS Stack size/offset = 8 */
#endif
#else
                                NdrFcShort( 0x8 ), /* PPC Stack size/offset = 8 */
#endif
#else
                                NdrFcShort( 0x8 ), /* Alpha Stack size/offset = 8 */
#endif
#endif
#endif
```

```

/* 54 */ NdrFcShort( 0x3c8 ),          /* Type Offset=968 */

    /* Parameter txn_out */

/* 56 */ NdrFcShort( 0x4113 ),          /* Flags: must size, must free, out, simple ref,
srv alloc size=16 */
#ifndef _ALPHA_
#ifndef _PPC_
#if !defined(_MIPS_)
/* 58 */ NdrFcShort( 0x14 ),/* x86 Stack size/offset = 20 */
#else
                                NdrFcShort( 0x18 ),/* MIPS Stack size/offset = 24 */
#endif
#else
                                NdrFcShort( 0x18 ),/* PPC Stack size/offset = 24 */
#endif
#else
                                NdrFcShort( 0x18 ),/* Alpha Stack size/offset = 24 */
#endif
/* 60 */ NdrFcShort( 0x3da ),          /* Type Offset=986 */

    /* Return value */

/* 62 */ NdrFcShort( 0x70 ),/* Flags: out, return, base type, */
#ifndef _ALPHA_
#ifndef _PPC_
#if !defined(_MIPS_)
/* 64 */ NdrFcShort( 0x18 ),/* x86 Stack size/offset = 24 */
#else
                                NdrFcShort( 0x1c ),/* MIPS Stack size/offset = 28 */
#endif
#else
                                NdrFcShort( 0x1c ),/* PPC Stack size/offset = 28 */
#endif
#else
                                NdrFcShort( 0x20 ),/* Alpha Stack size/offset = 32 */
#endif
/* 66 */ 0x8,
          /* FC_LONG */
          0x0,
          /* 0 */

    /* Procedure Delivery */

/* 68 */ 0x33,
          /* FC_AUTO_HANDLE */
          0x6c,
          /* Old Flags: object, Oi2 */

/* 70 */ NdrFcLong( 0x0 ), /* 0 */
/* 74 */ NdrFcShort( 0x5 ), /* 5 */
#ifndef _ALPHA_
#ifndef _PPC_
#if !defined(_MIPS_)
/* 76 */ NdrFcShort( 0x1c ),/* x86 Stack size/offset = 28 */
#else
                                NdrFcShort( 0x20 ),/* MIPS Stack size/offset = 32 */
#endif
#else
                                NdrFcShort( 0x20 ),/* PPC Stack size/offset = 32 */
#endif
#else
                                NdrFcShort( 0x28 ),/* Alpha Stack size/offset = 40 */
#endif
/* 78 */ NdrFcShort( 0x0 ), /* 0 */
/* 80 */ NdrFcShort( 0x8 ), /* 8 */
/* 82 */ 0x7,
          /* Oi2 Flags: srv must size, clt must size, has return, */
          0x3,
          /* 3 */
```

Appendix A - Application Source Code

```
/* Parameter txn_in */

/* 84 */ NdrFcShort( 0x8b ), /* Flags: must size, must free, in, by val, */
#ifdef _ALPHA_
#ifdef _PPC_
#if !defined(_MIPS_)
/* 86 */ NdrFcShort( 0x4 ), /* x86 Stack size/offset = 4 */
#else
NdrFcShort( 0x8 ), /* MIPS Stack size/offset = 8 */
#endif
#else
NdrFcShort( 0x8 ), /* PPC Stack size/offset = 8 */
#endif
#else
NdrFcShort( 0x8 ), /* Alpha Stack size/offset = 8 */
#endif
/* 88 */ NdrFcShort( 0x3c8 ), /* Type Offset=968 */

/* Parameter txn_out */

/* 90 */ NdrFcShort( 0x4113 ), /* Flags: must size, must free, out, simple ref,
srv alloc size=16 */
#ifdef _ALPHA_
#ifdef _PPC_
#if !defined(_MIPS_)
/* 92 */ NdrFcShort( 0x14 ), /* x86 Stack size/offset = 20 */
#else
NdrFcShort( 0x18 ), /* MIPS Stack size/offset = 24 */
#endif
#else
NdrFcShort( 0x18 ), /* PPC Stack size/offset = 24 */
#endif
#else
NdrFcShort( 0x18 ), /* Alpha Stack size/offset = 24 */
#endif
/* 94 */ NdrFcShort( 0x3da ), /* Type Offset=986 */

/* Return value */

/* 96 */ NdrFcShort( 0x70 ), /* Flags: out, return, base type, */
#ifdef _ALPHA_
#ifdef _PPC_
#if !defined(_MIPS_)
/* 98 */ NdrFcShort( 0x18 ), /* x86 Stack size/offset = 24 */
#else
NdrFcShort( 0x1c ), /* MIPS Stack size/offset = 28 */
#endif
#else
NdrFcShort( 0x1c ), /* PPC Stack size/offset = 28 */
#endif
#else
NdrFcShort( 0x20 ), /* Alpha Stack size/offset = 32 */
#endif
/* 100 */ 0x8, /* FC_LONG */
0x0, /* 0 */

/* Procedure StockLevel */

/* 102 */ 0x33, /* FC_AUTO_HANDLE */
0x6c, /* Old Flags: object, Oi2 */
/* 104 */ NdrFcLong( 0x0 ), /* 0 */
/* 108 */ NdrFcShort( 0x6 ), /* 6 */
```

```
#ifndef _ALPHA_
#ifdef _PPC_
#if !defined(_MIPS_)
/* 110 */ NdrFcShort( 0x1c ), /* x86 Stack size/offset = 28 */
#else
NdrFcShort( 0x20 ), /* MIPS Stack size/offset = 32 */
#endif
#else
NdrFcShort( 0x20 ), /* PPC Stack size/offset = 32 */
#endif
#else
NdrFcShort( 0x28 ), /* Alpha Stack size/offset = 40 */
#endif
/* 112 */ NdrFcShort( 0x0 ), /* 0 */
/* 114 */ NdrFcShort( 0x8 ), /* 8 */
/* 116 */ 0x7, /* Oi2 Flags: srv must size, clt must size, has return, */
0x3, /* 3 */

/* Parameter txn_in */

/* 118 */ NdrFcShort( 0x8b ), /* Flags: must size, must free, in, by val, */
#ifdef _ALPHA_
#ifdef _PPC_
#if !defined(_MIPS_)
/* 120 */ NdrFcShort( 0x4 ), /* x86 Stack size/offset = 4 */
#else
NdrFcShort( 0x8 ), /* MIPS Stack size/offset = 8 */
#endif
#else
NdrFcShort( 0x8 ), /* PPC Stack size/offset = 8 */
#endif
#else
NdrFcShort( 0x8 ), /* Alpha Stack size/offset = 8 */
#endif
/* 122 */ NdrFcShort( 0x3c8 ), /* Type Offset=968 */

/* Parameter txn_out */

/* 124 */ NdrFcShort( 0x4113 ), /* Flags: must size, must free, out, simple ref,
srv alloc size=16 */
#ifdef _ALPHA_
#ifdef _PPC_
#if !defined(_MIPS_)
/* 126 */ NdrFcShort( 0x14 ), /* x86 Stack size/offset = 20 */
#else
NdrFcShort( 0x18 ), /* MIPS Stack size/offset = 24 */
#endif
#else
NdrFcShort( 0x18 ), /* PPC Stack size/offset = 24 */
#endif
#else
NdrFcShort( 0x18 ), /* Alpha Stack size/offset = 24 */
#endif
/* 128 */ NdrFcShort( 0x3da ), /* Type Offset=986 */

/* Return value */

/* 130 */ NdrFcShort( 0x70 ), /* Flags: out, return, base type, */
#ifdef _ALPHA_
#ifdef _PPC_
#if !defined(_MIPS_)
/* 132 */ NdrFcShort( 0x18 ), /* x86 Stack size/offset = 24 */
#else
```

Appendix A - Application Source Code

```

                                NdrFcShort( 0x1c ),/* MIPS Stack size/offset = 28 */
#endif
#else
                                NdrFcShort( 0x1c ),/* PPC Stack size/offset = 28 */
#endif
#else
                                NdrFcShort( 0x20 ),/* Alpha Stack size/offset = 32 */
#endif
/* 134 *//0x8,
                                /* FC_LONG */
                                0x0,
                                /* 0 */

                                /* Procedure OrderStatus */

/* 136 *//0x33,
                                /* FC_AUTO_HANDLE */
                                0x6c,
                                /* Old Flags: object, Oi2 */
/* 138 *//NdrFcLong( 0x0 ), /* 0 */
/* 142 *//NdrFcShort( 0x7 ), /* 7 */
#ifdef _ALPHA_
#ifdef _PPC_
#if !defined(_MIPS_)
/* 144 *//NdrFcShort( 0x1c ),/* x86 Stack size/offset = 28 */
#else
                                NdrFcShort( 0x20 ),/* MIPS Stack size/offset = 32 */
#endif
#else
                                NdrFcShort( 0x20 ),/* PPC Stack size/offset = 32 */
#endif
#else
                                NdrFcShort( 0x28 ),/* Alpha Stack size/offset = 40 */
#endif
/* 146 *//NdrFcShort( 0x0 ), /* 0 */
/* 148 *//NdrFcShort( 0x8 ), /* 8 */
/* 150 *//0x7,
                                /* Oi2 Flags: srv must size, clt must size, has return, */
                                0x3,
                                /* 3 */

                                /* Parameter txn_in */

/* 152 *//NdrFcShort( 0x8b ),/* Flags: must size, must free, in, by val, */
#ifdef _ALPHA_
#ifdef _PPC_
#if !defined(_MIPS_)
/* 154 *//NdrFcShort( 0x4 ), /* x86 Stack size/offset = 4 */
#else
                                NdrFcShort( 0x8 ), /* MIPS Stack size/offset = 8 */
#endif
#else
                                NdrFcShort( 0x8 ), /* PPC Stack size/offset = 8 */
#endif
#else
                                NdrFcShort( 0x8 ), /* Alpha Stack size/offset = 8 */
#endif
/* 156 *//NdrFcShort( 0x3c8 ),
                                /* Type Offset=968 */

                                /* Parameter txn_out */

/* 158 *//NdrFcShort( 0x4113 ),
                                /* Flags: must size, must free, out, simple ref,
srv alloc size=16 */
#ifdef _ALPHA_
#ifdef _PPC_
#if !defined(_MIPS_)
/* 160 *//NdrFcShort( 0x14 ),/* x86 Stack size/offset = 20 */
#else
                                NdrFcShort( 0x18 ),/* MIPS Stack size/offset = 24 */

```

```

#endif
#else
                                NdrFcShort( 0x18 ),/* PPC Stack size/offset = 24 */
#endif
#else
                                NdrFcShort( 0x18 ),/* Alpha Stack size/offset = 24 */
#endif
/* 162 *//NdrFcShort( 0x3da ),
                                /* Type Offset=986 */

                                /* Return value */

/* 164 *//NdrFcShort( 0x70 ),/* Flags: out, return, base type, */
#ifdef _ALPHA_
#ifdef _PPC_
#if !defined(_MIPS_)
/* 166 *//NdrFcShort( 0x18 ),/* x86 Stack size/offset = 24 */
#else
                                NdrFcShort( 0x1c ),/* MIPS Stack size/offset = 28 */
#endif
#else
                                NdrFcShort( 0x1c ),/* PPC Stack size/offset = 28 */
#endif
#else
                                NdrFcShort( 0x20 ),/* Alpha Stack size/offset = 32 */
#endif
/* 168 *//0x8,
                                /* FC_LONG */
                                0x0,
                                /* 0 */

                                /* Procedure CallSetComplete */

/* 170 *//0x33,
                                /* FC_AUTO_HANDLE */
                                0x6c,
                                /* Old Flags: object, Oi2 */
/* 172 *//NdrFcLong( 0x0 ), /* 0 */
/* 176 *//NdrFcShort( 0x8 ), /* 8 */
#ifdef _ALPHA_
/* 178 *//NdrFcShort( 0x8 ), /* x86, MIPS, PPC Stack size/offset = 8 */
#else
                                NdrFcShort( 0x10 ),/* Alpha Stack size/offset = 16 */
#endif
/* 180 *//NdrFcShort( 0x0 ), /* 0 */
/* 182 *//NdrFcShort( 0x8 ), /* 8 */
/* 184 *//0x4,
                                /* Oi2 Flags: has return, */
                                0x1,
                                /* 1 */

                                /* Return value */

/* 186 *//NdrFcShort( 0x70 ),/* Flags: out, return, base type, */
#ifdef _ALPHA_
/* 188 *//NdrFcShort( 0x4 ), /* x86, MIPS, PPC Stack size/offset = 4 */
#else
                                NdrFcShort( 0x8 ), /* Alpha Stack size/offset = 8 */
#endif
/* 190 *//0x8,
                                /* FC_LONG */
                                0x0,
                                /* 0 */

                                0x0

                                }
};

static const MIDL_TYPE_FORMAT_STRING __MIDL_TypeFormatString =
{
    0,
    {

```

Appendix A - Application Source Code

```

                                NdrFcShort( 0x0 ), /* 0 */
/* 2 */
                                0x12, 0x0, /* FC_UP */
/* 4 */ NdrFcShort( 0x3b0 ), /* Offset= 944 (948) */
/* 6 */
                                0x2b, /* FC_NON_ENCAPSULATED_UNION */
                                0x9, /* FC_ULONG */
/* 8 */ 0x7, /* Corr desc: FC_USHORT */
                                0x0, /* */
/* 10 */ NdrFcShort( 0xffff8 ), /* -8 */
/* 12 */ NdrFcShort( 0x2 ), /* Offset= 2 (14) */
/* 14 */ NdrFcShort( 0x10 ), /* 16 */
/* 16 */ NdrFcShort( 0x2b ), /* 43 */
/* 18 */ NdrFcLong( 0x3 ), /* 3 */
/* 22 */ NdrFcShort( 0x8008 ), /* Simple arm type: FC_LONG */
/* 24 */ NdrFcLong( 0x11 ), /* 17 */
/* 28 */ NdrFcShort( 0x8001 ), /* Simple arm type: FC_BYTE */
/* 30 */ NdrFcLong( 0x2 ), /* 2 */
/* 34 */ NdrFcShort( 0x8006 ), /* Simple arm type: FC_SHORT */
/* 36 */ NdrFcLong( 0x4 ), /* 4 */
/* 40 */ NdrFcShort( 0x800a ), /* Simple arm type: FC_FLOAT */
/* 42 */ NdrFcLong( 0x5 ), /* 5 */
/* 46 */ NdrFcShort( 0x800c ), /* Simple arm type: FC_DOUBLE */
/* 48 */ NdrFcLong( 0xb ), /* 11 */
/* 52 */ NdrFcShort( 0x8006 ), /* Simple arm type: FC_SHORT */
/* 54 */ NdrFcLong( 0xa ), /* 10 */
/* 58 */ NdrFcShort( 0x8008 ), /* Simple arm type: FC_LONG */
/* 60 */ NdrFcLong( 0x6 ), /* 6 */
/* 64 */ NdrFcShort( 0xd6 ), /* Offset= 214 (278) */
/* 66 */ NdrFcLong( 0x7 ), /* 7 */
/* 70 */ NdrFcShort( 0x800c ), /* Simple arm type: FC_DOUBLE */
/* 72 */ NdrFcLong( 0x8 ), /* 8 */
/* 76 */ NdrFcShort( 0xd0 ), /* Offset= 208 (284) */
/* 78 */ NdrFcLong( 0xd ), /* 13 */
/* 82 */ NdrFcShort( 0xe2 ), /* Offset= 226 (308) */
/* 84 */ NdrFcLong( 0x9 ), /* 9 */
/* 88 */ NdrFcShort( 0xee ), /* Offset= 238 (326) */
/* 90 */ NdrFcLong( 0x2000 ), /* 8192 */
/* 94 */ NdrFcShort( 0xfa ), /* Offset= 250 (344) */
/* 96 */ NdrFcLong( 0x24 ), /* 36 */
/* 100 */ NdrFcShort( 0x308 ), /* Offset= 776 (876) */
/* 102 */ NdrFcLong( 0x4024 ), /* 16420 */
/* 106 */ NdrFcShort( 0x302 ), /* Offset= 770 (876) */
/* 108 */ NdrFcLong( 0x4011 ), /* 16401 */
/* 112 */ NdrFcShort( 0x300 ), /* Offset= 768 (880) */
/* 114 */ NdrFcLong( 0x4002 ), /* 16386 */
/* 118 */ NdrFcShort( 0x2fe ), /* Offset= 766 (884) */
/* 120 */ NdrFcLong( 0x4003 ), /* 16387 */
/* 124 */ NdrFcShort( 0x2fc ), /* Offset= 764 (888) */
/* 126 */ NdrFcLong( 0x4004 ), /* 16388 */
/* 130 */ NdrFcShort( 0x2fa ), /* Offset= 762 (892) */
/* 132 */ NdrFcLong( 0x4005 ), /* 16389 */
/* 136 */ NdrFcShort( 0x2f8 ), /* Offset= 760 (896) */
/* 138 */ NdrFcLong( 0x400b ), /* 16395 */
/* 142 */ NdrFcShort( 0x2e6 ), /* Offset= 742 (884) */
/* 144 */ NdrFcLong( 0x400a ), /* 16394 */
/* 148 */ NdrFcShort( 0x2e4 ), /* Offset= 740 (888) */
/* 150 */ NdrFcLong( 0x4006 ), /* 16390 */
/* 154 */ NdrFcShort( 0x2ea ), /* Offset= 746 (900) */
/* 156 */ NdrFcLong( 0x4007 ), /* 16391 */
/* 160 */ NdrFcShort( 0x2e0 ), /* Offset= 736 (896) */
/* 162 */ NdrFcLong( 0x4008 ), /* 16392 */
/* 166 */ NdrFcShort( 0x2e2 ), /* Offset= 738 (904) */
```

```

/* 168 */ NdrFcLong( 0x400d ), /* 16397 */
/* 172 */ NdrFcShort( 0x2e0 ), /* Offset= 736 (908) */
/* 174 */ NdrFcLong( 0x4009 ), /* 16393 */
/* 178 */ NdrFcShort( 0x2de ), /* Offset= 734 (912) */
/* 180 */ NdrFcLong( 0x6000 ), /* 24576 */
/* 184 */ NdrFcShort( 0x2dc ), /* Offset= 732 (916) */
/* 186 */ NdrFcLong( 0x400c ), /* 16396 */
/* 190 */ NdrFcShort( 0x2da ), /* Offset= 730 (920) */
/* 192 */ NdrFcLong( 0x10 ), /* 16 */
/* 196 */ NdrFcShort( 0x8002 ), /* Simple arm type: FC_CHAR */
/* 198 */ NdrFcLong( 0x12 ), /* 18 */
/* 202 */ NdrFcShort( 0x8006 ), /* Simple arm type: FC_SHORT */
/* 204 */ NdrFcLong( 0x13 ), /* 19 */
/* 208 */ NdrFcShort( 0x8008 ), /* Simple arm type: FC_LONG */
/* 210 */ NdrFcLong( 0x16 ), /* 22 */
/* 214 */ NdrFcShort( 0x8008 ), /* Simple arm type: FC_LONG */
/* 216 */ NdrFcLong( 0x17 ), /* 23 */
/* 220 */ NdrFcShort( 0x8008 ), /* Simple arm type: FC_LONG */
/* 222 */ NdrFcLong( 0xe ), /* 14 */
/* 226 */ NdrFcShort( 0x2be ), /* Offset= 702 (928) */
/* 228 */ NdrFcLong( 0x400e ), /* 16398 */
/* 232 */ NdrFcShort( 0x2c4 ), /* Offset= 708 (940) */
/* 234 */ NdrFcLong( 0x4010 ), /* 16400 */
/* 238 */ NdrFcShort( 0x2c2 ), /* Offset= 706 (944) */
/* 240 */ NdrFcLong( 0x4012 ), /* 16402 */
/* 244 */ NdrFcShort( 0x280 ), /* Offset= 640 (884) */
/* 246 */ NdrFcLong( 0x4013 ), /* 16403 */
/* 250 */ NdrFcShort( 0x27e ), /* Offset= 638 (888) */
/* 252 */ NdrFcLong( 0x4016 ), /* 16406 */
/* 256 */ NdrFcShort( 0x278 ), /* Offset= 632 (888) */
/* 258 */ NdrFcLong( 0x4017 ), /* 16407 */
/* 262 */ NdrFcShort( 0x272 ), /* Offset= 626 (888) */
/* 264 */ NdrFcLong( 0x0 ), /* 0 */
/* 268 */ NdrFcShort( 0x0 ), /* Offset= 0 (268) */
/* 270 */ NdrFcLong( 0x1 ), /* 1 */
/* 274 */ NdrFcShort( 0x0 ), /* Offset= 0 (274) */
/* 276 */ NdrFcShort( 0xffffffff ), /* Offset= -1 (275) */
/* 278 */
                                0x15, /* FC_STRUCT */
                                0x7, /* 7 */
/* 280 */ NdrFcShort( 0x8 ), /* 8 */
/* 282 */ 0xb, /* FC_HYPER */
                                0x5b, /* FC_END */
/* 284 */
                                0x12, 0x0, /* FC_UP */
/* 286 */ NdrFcShort( 0xc ), /* Offset= 12 (298) */
/* 288 */
                                0x1b, /* FC_CARRAY */
                                0x1, /* 1 */
/* 290 */ NdrFcShort( 0x2 ), /* 2 */
/* 292 */ 0x9, /* Corr desc: FC_ULONG */
                                0x0, /* */
/* 294 */ NdrFcShort( 0xffffc ), /* -4 */
/* 296 */ 0x6, /* FC_SHORT */
                                0x5b, /* FC_END */
/* 298 */
                                0x17, /* FC_CSTRUCT */
                                0x3, /* 3 */
/* 300 */ NdrFcShort( 0x8 ), /* 8 */
/* 302 */ NdrFcShort( 0xffffffff2 ), /* Offset= -14 (288) */
/* 304 */ 0x8, /* FC_LONG */
                                0x8, /* FC_LONG */
/* 306 */ 0x5c, /* FC_PAD */
```

Appendix A - Application Source Code

```
/* 308 */
    0x5b,          /* FC_END */
/* 310 */NdrFcLong( 0x0 ), /* 0 */
/* 314 */NdrFcShort( 0x0 ), /* 0 */
/* 316 */NdrFcShort( 0x0 ), /* 0 */
/* 318 */0xc0, /* 192 */
/* 320 */0x0, /* 0 */
/* 322 */0x0, /* 0 */
/* 324 */0x0, /* 0 */
/* 326 */
    0x2f,          /* FC_IP */
    0x5a,          /* FC_CONSTANT_IID */
/* 328 */NdrFcLong( 0x20400 ), /* 132096 */
/* 332 */NdrFcShort( 0x0 ), /* 0 */
/* 334 */NdrFcShort( 0x0 ), /* 0 */
/* 336 */0xc0, /* 192 */
/* 338 */0x0, /* 0 */
/* 340 */0x0, /* 0 */
/* 342 */0x0, /* 0 */
/* 344 */
    0x12, 0x10,   /* FC_UP [pointer_deref] */
/* 346 */NdrFcShort( 0x2 ), /* Offset= 2 (348) */
/* 348 */
    0x12, 0x0,    /* FC_UP */
/* 350 */NdrFcShort( 0x1fc ), /* Offset= 508 (858) */
/* 352 */
    0x2a,          /* FC_ENCAPSULATED_UNION */
    0x49,          /* 73 */
/* 354 */NdrFcShort( 0x18 ), /* 24 */
/* 356 */NdrFcShort( 0xa ), /* 10 */
/* 358 */NdrFcLong( 0x8 ), /* 8 */
/* 362 */NdrFcShort( 0x58 ), /* Offset= 88 (450) */
/* 364 */NdrFcLong( 0xd ), /* 13 */
/* 368 */NdrFcShort( 0x78 ), /* Offset= 120 (488) */
/* 370 */NdrFcLong( 0x9 ), /* 9 */
/* 374 */NdrFcShort( 0x94 ), /* Offset= 148 (522) */
/* 376 */NdrFcLong( 0xc ), /* 12 */
/* 380 */NdrFcShort( 0xbc ), /* Offset= 188 (568) */
/* 382 */NdrFcLong( 0x24 ), /* 36 */
/* 386 */NdrFcShort( 0x114 ), /* Offset= 276 (662) */
/* 388 */NdrFcLong( 0x800d ), /* 32781 */
/* 392 */NdrFcShort( 0x130 ), /* Offset= 304 (696) */
/* 394 */NdrFcLong( 0x10 ), /* 16 */
/* 398 */NdrFcShort( 0x148 ), /* Offset= 328 (726) */
/* 400 */NdrFcLong( 0x2 ), /* 2 */
/* 404 */NdrFcShort( 0x160 ), /* Offset= 352 (756) */
/* 406 */NdrFcLong( 0x3 ), /* 3 */
/* 410 */NdrFcShort( 0x178 ), /* Offset= 376 (786) */
/* 412 */NdrFcLong( 0x14 ), /* 20 */
/* 416 */NdrFcShort( 0x190 ), /* Offset= 400 (816) */
/* 418 */NdrFcShort( 0xffffffff ), /* Offset= -1 (417) */
/* 420 */
    0x1b,          /* FC_CARRY */
```

```
/* 422 */NdrFcShort( 0x4 ), /* 4 */
/* 424 */0x19, /* Corr desc: field pointer, FC_ULONG */
/* 426 */NdrFcShort( 0x0 ), /* 0 */
/* 428 */
    0x4b,          /* FC_PP */
    0x5c,          /* FC_PAD */
/* 430 */
    0x48,          /* FC_VARIABLE_REPEAT */
    0x49,          /* FC_FIXED_OFFSET */
/* 432 */NdrFcShort( 0x4 ), /* 4 */
/* 434 */NdrFcShort( 0x0 ), /* 0 */
/* 436 */NdrFcShort( 0x1 ), /* 1 */
/* 438 */NdrFcShort( 0x0 ), /* 0 */
/* 440 */NdrFcShort( 0x0 ), /* 0 */
/* 442 */0x12, 0x0, /* FC_UP */
/* 444 */NdrFcShort( 0xffffffff6e ), /* Offset= -146 (298) */
/* 446 */
    0x5b,          /* FC_END */
/* 448 */0x5c, /* FC_LONG */
/* 450 */
    0x16,          /* FC_PSTRUCT */
    0x3,           /* 3 */
/* 452 */NdrFcShort( 0x8 ), /* 8 */
/* 454 */
    0x4b,          /* FC_PP */
    0x5c,          /* FC_PAD */
/* 456 */
    0x46,          /* FC_NO_REPEAT */
    0x5c,          /* FC_PAD */
/* 458 */NdrFcShort( 0x4 ), /* 4 */
/* 460 */NdrFcShort( 0x4 ), /* 4 */
/* 462 */0x11, 0x0, /* FC_RP */
/* 464 */NdrFcShort( 0xffffffffd4 ), /* Offset= -44 (420) */
/* 466 */
    0x5b,          /* FC_END */
/* 468 */0x8, /* FC_LONG */
/* 470 */
    0x21,          /* FC_BOGUS_ARRAY */
    0x3,           /* 3 */
/* 472 */NdrFcShort( 0x0 ), /* 0 */
/* 474 */0x19, /* Corr desc: field pointer, FC_ULONG */
/* 476 */NdrFcShort( 0x0 ), /* 0 */
/* 478 */NdrFcLong( 0xffffffff ), /* -1 */
/* 482 */0x4c, /* FC_EMBEDDED_COMPLEX */
    0x0,           /* 0 */
/* 484 */NdrFcShort( 0xffffffff50 ), /* Offset= -176 (308) */
/* 486 */0x5c, /* FC_PAD */
    0x5b,          /* FC_END */
/* 488 */
    0x1a,          /* FC_BOGUS_STRUCT */
    0x3,           /* 3 */
/* 490 */NdrFcShort( 0x8 ), /* 8 */
/* 492 */NdrFcShort( 0x0 ), /* 0 */
/* 494 */NdrFcShort( 0x6 ), /* Offset= 6 (500) */
```

Appendix A - Application Source Code

```
/* 496 */ 0x8, /* FC_LONG */
/* 498 */ 0x5c, /* FC_POINTER */
/* 500 */ 0x5b, /* FC_POINTER */
/* 502 */ NdrFcShort( 0xfffffe0 ), /* Offset= -32 (470) */
/* 504 */ 0x21, /* FC_BOGUS_ARRAY */
/* 506 */ NdrFcShort( 0x0 ), /* 0 */
/* 508 */ 0x19, /* Corr desc: field pointer, FC_ULONG */
/* 510 */ NdrFcShort( 0x0 ), /* 0 */
/* 512 */ NdrFcLong( 0xffffffff ), /* -1 */
/* 516 */ 0x4c, /* FC_EMBEDDED_COMPLEX */
/* 518 */ NdrFcShort( 0xfffff40 ), /* Offset= -192 (326) */
/* 520 */ 0x5c, /* FC_PAD */
/* 522 */ 0x1a, /* FC_BOGUS_STRUCT */
/* 524 */ NdrFcShort( 0x8 ), /* 8 */
/* 526 */ NdrFcShort( 0x0 ), /* 0 */
/* 528 */ NdrFcShort( 0x6 ), /* Offset= 6 (534) */
/* 530 */ 0x8, /* FC_LONG */
/* 532 */ 0x5c, /* FC_POINTER */
/* 534 */ 0x11, 0x0, /* FC_RP */
/* 536 */ NdrFcShort( 0xfffffe0 ), /* Offset= -32 (504) */
/* 538 */ 0x1b, /* FC_CARRAY */
/* 540 */ NdrFcShort( 0x4 ), /* 4 */
/* 542 */ 0x19, /* Corr desc: field pointer, FC_ULONG */
/* 544 */ NdrFcShort( 0x0 ), /* 0 */
/* 546 */ 0x4b, /* FC_PP */
/* 548 */ 0x5c, /* FC_PAD */
/* 550 */ NdrFcShort( 0x4 ), /* 4 */
/* 552 */ NdrFcShort( 0x0 ), /* 0 */
/* 554 */ NdrFcShort( 0x1 ), /* 1 */
/* 556 */ NdrFcShort( 0x0 ), /* 0 */
/* 558 */ NdrFcShort( 0x0 ), /* 0 */
/* 560 */ 0x12, 0x0, /* FC_UP */
/* 562 */ NdrFcShort( 0x182 ), /* Offset= 386 (948) */
/* 564 */ 0x5b, /* FC_END */
/* 566 */ 0x8, /* FC_LONG */
/* 568 */ 0x5b, /* FC_END */
/* 570 */ NdrFcShort( 0x8 ), /* 8 */
```

```
/* 572 */ NdrFcShort( 0x0 ), /* 0 */
/* 574 */ NdrFcShort( 0x6 ), /* Offset= 6 (580) */
/* 576 */ 0x8, /* FC_LONG */
/* 578 */ 0x5c, /* FC_POINTER */
/* 580 */ 0x5b, /* FC_POINTER */
/* 582 */ 0x11, 0x0, /* FC_RP */
/* 584 */ 0x2f, /* FC_IP */
/* 586 */ NdrFcLong( 0x2f ), /* 47 */
/* 590 */ NdrFcShort( 0x0 ), /* 0 */
/* 592 */ NdrFcShort( 0x0 ), /* 0 */
/* 594 */ 0xc0, /* 192 */
/* 596 */ 0x0, /* 0 */
/* 598 */ 0x0, /* 0 */
/* 600 */ 0x0, /* 0 */
/* 602 */ 0x46, /* 70 */
/* 604 */ NdrFcShort( 0x1 ), /* 1 */
/* 606 */ 0x19, /* Corr desc: field pointer, FC_ULONG */
/* 608 */ NdrFcShort( 0x4 ), /* 4 */
/* 610 */ 0x1, /* FC_BYTE */
/* 612 */ 0x5b, /* FC_END */
/* 614 */ NdrFcShort( 0x10 ), /* 16 */
/* 616 */ NdrFcShort( 0x0 ), /* 0 */
/* 618 */ NdrFcShort( 0xa ), /* Offset= 10 (628) */
/* 620 */ 0x8, /* FC_LONG */
/* 622 */ 0x4c, /* FC_EMBEDDED_COMPLEX */
/* 624 */ NdrFcShort( 0xfffffd8 ), /* Offset= -40 (584) */
/* 626 */ 0x36, /* FC_POINTER */
/* 628 */ 0x5b, /* FC_END */
/* 630 */ 0x12, 0x0, /* FC_UP */
/* 632 */ 0x1b, /* FC_CARRAY */
/* 634 */ NdrFcShort( 0x4 ), /* 4 */
/* 636 */ 0x19, /* Corr desc: field pointer, FC_ULONG */
/* 638 */ NdrFcShort( 0x0 ), /* 0 */
/* 640 */ 0x4b, /* FC_PP */
/* 642 */ 0x5c, /* FC_PAD */
/* 644 */ NdrFcShort( 0x4 ), /* 4 */
/* 646 */ NdrFcShort( 0x0 ), /* 0 */
```

Appendix A - Application Source Code

```
/* 648 */NdrFcShort( 0x1 ), /* 1 */
/* 650 */NdrFcShort( 0x0 ), /* 0 */
/* 652 */NdrFcShort( 0x0 ), /* 0 */
/* 654 */0x12, 0x0, /* FC_UP */
/* 656 */NdrFcShort( 0xfffffd4 ), /* Offset= -44 (612) */
/* 658 */
    0x5b, /* FC_END */
    0x8, /* FC_LONG */
/* 660 */0x5c, /* FC_PAD */
    0x5b, /* FC_END */
/* 662 */
    0x1a, /* FC_BOGUS_STRUCT */
    0x3, /* 3 */
/* 664 */NdrFcShort( 0x8 ), /* 8 */
/* 666 */NdrFcShort( 0x0 ), /* 0 */
/* 668 */NdrFcShort( 0x6 ), /* Offset= 6 (674) */
/* 670 */0x8, /* FC_LONG */
/* 672 */0x5c, /* FC_POINTER */
/* 674 */0x5b, /* FC_END */
    0x11, 0x0, /* FC_RP */
/* 676 */NdrFcShort( 0xfffffd4 ), /* Offset= -44 (632) */
/* 678 */
    0x1d, /* FC_SMFARRAY */
    0x0, /* 0 */
/* 680 */NdrFcShort( 0x8 ), /* 8 */
/* 682 */0x2, /* FC_CHAR */
    0x5b, /* FC_END */
    0x15, /* FC_STRUCT */
    0x3, /* 3 */
/* 686 */NdrFcShort( 0x10 ), /* 16 */
/* 688 */0x8, /* FC_LONG */
    0x6, /* FC_SHORT */
/* 690 */0x6, /* FC_SHORT */
    0x4c, /* FC_EMBEDDED_COMPLEX */
/* 692 */0x0, /* 0 */
    NdrFcShort( 0xfffff1 ), /* Offset= -15 (678) */
/* 696 */0x5b, /* FC_END */
    0x1a, /* FC_BOGUS_STRUCT */
    0x3, /* 3 */
/* 698 */NdrFcShort( 0x18 ), /* 24 */
/* 700 */NdrFcShort( 0x0 ), /* 0 */
/* 702 */NdrFcShort( 0xa ), /* Offset= 10 (712) */
/* 704 */0x8, /* FC_LONG */
    0x36, /* FC_POINTER */
/* 706 */0x4c, /* FC_EMBEDDED_COMPLEX */
    0x0, /* 0 */
/* 708 */NdrFcShort( 0xffffffe8 ), /* Offset= -24 (684) */
/* 710 */0x5c, /* FC_PAD */
    0x5b, /* FC_END */
/* 712 */
    0x11, 0x0, /* FC_RP */
/* 714 */NdrFcShort( 0xfffff0c ), /* Offset= -244 (470) */
/* 716 */
    0x1b, /* FC_CARRAY */
    0x0, /* 0 */
/* 718 */NdrFcShort( 0x1 ), /* 1 */
/* 720 */0x19, /* Corr desc: field pointer, FC_ULONG */
    0x0, /* */
```

```
/* 722 */NdrFcShort( 0x0 ), /* 0 */
/* 724 */0x1, /* FC_BYTE */
    0x5b, /* FC_END */
/* 726 */
    0x16, /* FC_PSTRUCT */
    0x3, /* 3 */
/* 728 */NdrFcShort( 0x8 ), /* 8 */
/* 730 */
    0x4b, /* FC_PP */
    0x5c, /* FC_PAD */
/* 732 */
    0x46, /* FC_NO_REPEAT */
    0x5c, /* FC_PAD */
/* 734 */NdrFcShort( 0x4 ), /* 4 */
/* 736 */NdrFcShort( 0x4 ), /* 4 */
/* 738 */0x12, 0x0, /* FC_UP */
/* 740 */NdrFcShort( 0xffffffe8 ), /* Offset= -24 (716) */
/* 742 */
    0x5b, /* FC_END */
    0x8, /* FC_LONG */
/* 744 */0x8, /* FC_LONG */
    0x5b, /* FC_END */
/* 746 */
    0x1b, /* FC_CARRAY */
    0x1, /* 1 */
/* 748 */NdrFcShort( 0x2 ), /* 2 */
/* 750 */0x19, /* Corr desc: field pointer, FC_ULONG */
    0x0, /* */
/* 752 */NdrFcShort( 0x0 ), /* 0 */
/* 754 */0x6, /* FC_SHORT */
    0x5b, /* FC_END */
/* 756 */
    0x16, /* FC_PSTRUCT */
    0x3, /* 3 */
/* 758 */NdrFcShort( 0x8 ), /* 8 */
/* 760 */
    0x4b, /* FC_PP */
    0x5c, /* FC_PAD */
/* 762 */
    0x46, /* FC_NO_REPEAT */
    0x5c, /* FC_PAD */
/* 764 */NdrFcShort( 0x4 ), /* 4 */
/* 766 */NdrFcShort( 0x4 ), /* 4 */
/* 768 */0x12, 0x0, /* FC_UP */
/* 770 */NdrFcShort( 0xffffffe8 ), /* Offset= -24 (746) */
/* 772 */
    0x5b, /* FC_END */
    0x8, /* FC_LONG */
/* 774 */0x8, /* FC_LONG */
    0x5b, /* FC_END */
/* 776 */
    0x1b, /* FC_CARRAY */
    0x3, /* 3 */
/* 778 */NdrFcShort( 0x4 ), /* 4 */
/* 780 */0x19, /* Corr desc: field pointer, FC_ULONG */
    0x0, /* */
/* 782 */NdrFcShort( 0x0 ), /* 0 */
/* 784 */0x8, /* FC_LONG */
    0x5b, /* FC_END */
/* 786 */
    0x16, /* FC_PSTRUCT */
```

Appendix A - Application Source Code

```
/* 788 */NdrFcShort( 0x8 ), /* 8 */
/* 790 */
                                0x4b, /* FC_PP */
                                0x5c, /* FC_PAD */
/* 792 */
                                0x46, /* FC_NO_REPEAT */
                                0x5c, /* FC_PAD */
/* 794 */NdrFcShort( 0x4 ), /* 4 */
/* 796 */NdrFcShort( 0x4 ), /* 4 */
/* 798 */0x12, 0x0, /* FC_UP */
/* 800 */NdrFcShort( 0xffffffe8 ), /* Offset= -24 (776) */
/* 802 */
                                0x5b, /* FC_END */
/* 804 */0x8,
                                0x8, /* FC_LONG */
                                0x5b, /* FC_END */
/* 806 */
                                0x1b, /* FC_CARRAY */
                                0x7, /* 7 */
/* 808 */NdrFcShort( 0x8 ), /* 8 */
/* 810 */0x19, /* Corr desc: field pointer, FC_ULONG */
                                0x0, /* */
/* 812 */NdrFcShort( 0x0 ), /* 0 */
/* 814 */0xb, /* FC_HYPER */
                                0x5b, /* FC_END */
/* 816 */
                                0x16, /* FC_PSTRUCT */
                                0x3, /* 3 */
/* 818 */NdrFcShort( 0x8 ), /* 8 */
/* 820 */
                                0x4b, /* FC_PP */
                                0x5c, /* FC_PAD */
/* 822 */
                                0x46, /* FC_NO_REPEAT */
                                0x5c, /* FC_PAD */
/* 824 */NdrFcShort( 0x4 ), /* 4 */
/* 826 */NdrFcShort( 0x4 ), /* 4 */
/* 828 */0x12, 0x0, /* FC_UP */
/* 830 */NdrFcShort( 0xffffffe8 ), /* Offset= -24 (806) */
/* 832 */
                                0x5b, /* FC_END */
/* 834 */0x8,
                                0x8, /* FC_LONG */
                                0x5b, /* FC_END */
/* 836 */
                                0x15, /* FC_STRUCT */
                                0x3, /* 3 */
/* 838 */NdrFcShort( 0x8 ), /* 8 */
/* 840 */0x8, /* FC_LONG */
                                0x8, /* FC_LONG */
                                0x5b, /* FC_PAD */
                                0x5b, /* FC_END */
/* 844 */
                                0x1b, /* FC_CARRAY */
                                0x3, /* 3 */
/* 846 */NdrFcShort( 0x8 ), /* 8 */
/* 848 */0x7, /* Corr desc: FC_USHORT */
                                0x0, /* */
/* 850 */NdrFcShort( 0xffd8 ), /* -40 */
/* 852 */0x4c, /* FC_EMBEDDED_COMPLEX */

                                0x0, /* 0 */
/* 854 */NdrFcShort( 0xfffffee ), /* Offset= -18 (836) */
/* 856 */0x5c, /* FC_PAD */
                                0x5b, /* FC_END */
/* 858 */
                                0x1a, /* FC_BOGUS_STRUCT */
                                0x3, /* 3 */
/* 860 */NdrFcShort( 0x28 ), /* 40 */
/* 862 */NdrFcShort( 0xfffffee ), /* Offset= -18 (844) */
/* 864 */NdrFcShort( 0x0 ), /* Offset= 0 (864) */
/* 866 */0x6, /* FC_SHORT */
                                0x6, /* FC_SHORT */
/* 868 */0x38, /* FC_ALIGNM4 */
                                0x8, /* FC_LONG */
/* 870 */0x8, /* FC_LONG */
                                0x4c, /* FC_EMBEDDED_COMPLEX */
/* 872 */0x0, /* 0 */
                                NdrFcShort( 0xfffffd7 ), /* Offset= -521 (352) */
                                0x5b, /* FC_END */
/* 876 */
                                0x12, 0x0, /* FC_UP */
/* 878 */NdrFcShort( 0xfffffe6 ), /* Offset= -266 (612) */
/* 880 */
                                0x12, 0x8, /* FC_UP [simple_pointer] */
                                0x5c, /* FC_BYTE */
                                0x5c, /* FC_PAD */
/* 884 */
                                0x12, 0x8, /* FC_UP [simple_pointer] */
                                0x5c, /* FC_SHORT */
                                0x5c, /* FC_PAD */
/* 888 */
                                0x12, 0x8, /* FC_UP [simple_pointer] */
                                0x5c, /* FC_LONG */
                                0x5c, /* FC_PAD */
/* 892 */
                                0x12, 0x8, /* FC_UP [simple_pointer] */
                                0x5c, /* FC_FLOAT */
                                0x5c, /* FC_PAD */
/* 896 */
                                0x12, 0x8, /* FC_UP [simple_pointer] */
                                0x5c, /* FC_DOUBLE */
                                0x5c, /* FC_PAD */
/* 900 */
                                0x12, 0x0, /* FC_UP */
/* 902 */NdrFcShort( 0xfffffd90 ), /* Offset= -624 (278) */
/* 904 */
                                0x12, 0x10, /* FC_UP [pointer_deref] */
                                0x5c, /* Offset= -622 (284) */
                                0x5c, /* FC_UP [pointer_deref] */
                                0x5c, /* Offset= -602 (308) */
                                0x5c, /* FC_UP [pointer_deref] */
                                0x5c, /* Offset= -588 (326) */
                                0x5c, /* FC_UP [pointer_deref] */
                                0x5c, /* Offset= -574 (344) */
                                0x5c, /* FC_UP [pointer_deref] */
                                0x5c, /* Offset= 2 (924) */
                                0x5c, /* FC_UP */
/* 926 */NdrFcShort( 0x16 ), /* Offset= 22 (948) */
```

Appendix A - Application Source Code

```
/* 928 */
    0x15,          /* FC_STRUCT */
    0x7,           /* 7 */
/* 930 */NdrFcShort( 0x10 ), /* 16 */
/* 932 */ 0x6,      /* FC_SHORT */
    0x1,          /* FC_BYTE */
/* 934 */ 0x1,      /* FC_BYTE */
    0x38,         /* FC_ALIGNM4 */
/* 936 */ 0x8,      /* FC_LONG */
    0x39,         /* FC_ALIGNM8 */
/* 938 */ 0xb,      /* FC_HYPER */
    0x5b,         /* FC_END */
/* 940 */
    0x12, 0x0,    /* FC_UP */
/* 942 */NdrFcShort( 0xffffffff2 ), /* Offset= -14 (928) */
/* 944 */
    0x12, 0x8,    /* FC_UP [simple_pointer] */
/* 946 */ 0x2,      /* FC_CHAR */
    0x5c,         /* FC_PAD */
/* 948 */
    0x1a,         /* FC_BOGUS_STRUCT */
    0x7,          /* 7 */
/* 950 */NdrFcShort( 0x20 ), /* 32 */
/* 952 */NdrFcShort( 0x0 ), /* 0 */
/* 954 */NdrFcShort( 0x0 ), /* Offset= 0 (954) */
/* 956 */ 0x8,      /* FC_LONG */
    0x8,          /* FC_LONG */
/* 958 */ 0x6,      /* FC_SHORT */
    0x6,          /* FC_SHORT */
/* 960 */ 0x6,      /* FC_SHORT */
    0x6,          /* FC_SHORT */
/* 962 */ 0x4c,     /* FC_EMBEDDED_COMPLEX */
    0x0,          /* 0 */
/* 964 */NdrFcShort( 0xfffffc42 ), /* Offset= -958 (6) */
/* 966 */ 0x5c,     /* FC_PAD */
    0x5b,         /* FC_END */
/* 968 */ 0xb4,     /* FC_USER_MARSHAL */
    0x83,         /* 131 */
/* 970 */NdrFcShort( 0x0 ), /* 0 */
/* 972 */NdrFcShort( 0x10 ), /* 16 */
/* 974 */NdrFcShort( 0x0 ), /* 0 */
/* 976 */NdrFcShort( 0xfffffc32 ), /* Offset= -974 (2) */
/* 978 */
    0x11, 0x4,    /* FC_RP [allocated_on_stack] */
/* 980 */NdrFcShort( 0x6 ), /* Offset= 6 (986) */
/* 982 */
    0x13, 0x0,    /* FC_OP */
/* 984 */NdrFcShort( 0xfffffcdc ), /* Offset= -36 (948) */
/* 986 */ 0xb4,     /* FC_USER_MARSHAL */
    0x83,         /* 131 */
/* 988 */NdrFcShort( 0x0 ), /* 0 */
/* 990 */NdrFcShort( 0x10 ), /* 16 */
/* 992 */NdrFcShort( 0x0 ), /* 0 */
/* 994 */NdrFcShort( 0xfffffff4 ), /* Offset= -12 (982) */
    0x0
};
}
const CInterfaceProxyVtbl * _tpcc_com_ps_ProxyVtblList[] =
{
    ( CInterfaceProxyVtbl * ) &_ITPCCProxyVtbl,
    0
};
```

```
};
const CInterfaceStubVtbl * _tpcc_com_ps_StubVtblList[] =
{
    ( CInterfaceStubVtbl * ) &_ITPCCStubVtbl,
    0
};
PCInterfaceName const _tpcc_com_ps_InterfaceNamesList[] =
{
    "ITPCC",
    0
};
#define _tpcc_com_ps_CHECK_IID(n) IID_GENERIC_CHECK_IID( _tpcc_com_ps, pIID, n)
int __stdcall _tpcc_com_ps_IID_Lookup( const IID * pIID, int * pIndex )
{
    if(!_tpcc_com_ps_CHECK_IID(0))
    {
        *pIndex = 0;
        return 1;
    }
    return 0;
}
const ExtendedProxyFileInfo tpcc_com_ps_ProxyFileInfo =
{
    (PCInterfaceProxyVtblList *) &_tpcc_com_ps_ProxyVtblList,
    (PCInterfaceStubVtblList *) &_tpcc_com_ps_StubVtblList,
    (const PCInterfaceName *) &_tpcc_com_ps_InterfaceNamesList,
    0, // no delegation
    &_tpcc_com_ps_IID_Lookup,
    1,
    2,
    0, /* table of [async_uuid] interfaces */
    0, /* Filler1 */
    0, /* Filler2 */
    0, /* Filler3 */
};
#endif /* !defined(_M_IA64) && !defined(_M_AXP64) */
#pragma warning( disable: 4049 ) /* more than 64k source lines */
/* this ALWAYS GENERATED file contains the proxy stub code */
/* File created by MIDL compiler version 5.03.0280 */
/* at Sat Apr 08 16:40:10 2000
*/
/* Compiler settings for .\src\tpcc_com_ps.idl:
Oicf (OptLev=12), W1, Zp8, env=Win64 (32b run,appending), ms_ext, c_ext, robust
error checks: allocation ref bounds_check enum stub_data
VC __declspec() decoration level:
__declspec(uuid()), __declspec(selectany), __declspec(novtable)
DECLSPEC_UUID(), MIDL_INTERFACE()
*/
```

Appendix A - Application Source Code

```
@@MIDL_FILE_HEADING( )

#if defined(_M_IA64) || defined(_M_AXP64)
#define USE_STUBLESS_PROXY

/* verify that the <rpcproxy.h> version is high enough to compile this file*/
#ifndef __REDQ_RPCPROXY_H_VERSION__
#define __REQUIRED_RPCPROXY_H_VERSION__ 475
#endif

#include "rpcproxy.h"
#ifndef __RPCPROXY_H_VERSION__
#error this stub requires an updated version of <rpcproxy.h>
#endif // __RPCPROXY_H_VERSION__

#include "tpcc_com_ps.h"

#define TYPE_FORMAT_STRING_SIZE 979
#define PROC_FORMAT_STRING_SIZE 253
#define TRANSMIT_AS_TABLE_SIZE 0
#define WIRE_MARSHAL_TABLE_SIZE 1

typedef struct _MIDL_TYPE_FORMAT_STRING
{
    short Pad;
    unsigned char Format[ TYPE_FORMAT_STRING_SIZE ];
} MIDL_TYPE_FORMAT_STRING;

typedef struct _MIDL_PROC_FORMAT_STRING
{
    short Pad;
    unsigned char Format[ PROC_FORMAT_STRING_SIZE ];
} MIDL_PROC_FORMAT_STRING;

extern const MIDL_TYPE_FORMAT_STRING __MIDL_TypeFormatString;
extern const MIDL_PROC_FORMAT_STRING __MIDL_ProcFormatString;

/* Standard interface: __MIDL_itf_tpcc_com_ps_0000, ver. 0.0,
GUID={0x00000000,0x0000,0x0000,{0x00,0x00,0x00,0x00,0x00,0x00,0x00,0x00}} */

/* Object interface: IUnknown, ver. 0.0,
GUID={0x00000000,0x0000,0x0000,{0xC0,0x00,0x00,0x00,0x00,0x00,0x00,0x46}} */

/* Object interface: ITPCC, ver. 0.0,
GUID={0xFEEB6AA2,0x84B1,0x11d2,{0xBA,0x47,0x00,0xC0,0x4F,0xBF,0xE0,0x8B}} */

extern const MIDL_STUB_DESC Object_StubDesc;

extern const MIDL_SERVER_INFO ITPCC_ServerInfo;

#pragma code_seg(".orpc")
static const unsigned short ITPCC_FormatStringOffsetTable[] =
{
    0,

```

```
44,
88,
132,
176,
220
};

static const MIDL_SERVER_INFO ITPCC_ServerInfo =
{
    &Object_StubDesc,
    0,
    __MIDL_ProcFormatString.Format,
    &ITPCC_FormatStringOffsetTable[-3],
    0,
    0,
    0,
    0
};

static const MIDL_STUBLESS_PROXY_INFO ITPCC_ProxyInfo =
{
    &Object_StubDesc,
    __MIDL_ProcFormatString.Format,
    &ITPCC_FormatStringOffsetTable[-3],
    0,
    0,
    0
};

CINTERFACE_PROXY_VTABLE(9) _ITPCCProxyVtbl =
{
    &ITPCC_ProxyInfo,
    &IID_ITPCC,
    IUnknown_QueryInterface_Proxy,
    IUnknown_AddRef_Proxy,
    IUnknown_Release_Proxy ,
    (void *)-1 /* ITPCC::NewOrder */ ,
    (void *)-1 /* ITPCC::Payment */ ,
    (void *)-1 /* ITPCC::Delivery */ ,
    (void *)-1 /* ITPCC::StockLevel */ ,
    (void *)-1 /* ITPCC::OrderStatus */ ,
    (void *)-1 /* ITPCC::CallSetComplete */
};

const CInterfaceStubVtbl _ITPCCStubVtbl =
{
    &IID_ITPCC,
    &ITPCC_ServerInfo,
    9,
    0, /* pure interpreted */
    CStdStubBuffer_METHODS
};

extern const USER_MARSHAL_ROUTINE_QUADRUPLE UserMarshalRoutines[ WIRE_MARSHAL_TABLE_SIZE
];

static const MIDL_STUB_DESC Object_StubDesc =
{
    0,
    NdrOleAllocate,
    NdrOleFree,
    0,
    0,

```

Appendix A - Application Source Code

```
0,
0,
0,
__MIDL_TypeFormatString.Format,
1, /* -error_bounds_check flag */
0x50002, /* Ndr library version */
0,
0x5030118, /* MIDL Version 5.3.280 */
0,
UserMarshalRoutines,
0, /* notify & notify_flag routine table */
0x1, /* MIDL flag */
0, /* Reserved3 */
0, /* Reserved4 */
0 /* Reserved5 */
};

#pragma data_seg(".rdata")

static const USER_MARSHAL_ROUTINE_QUADRUPLE UserMarshalRoutines[ WIRE_MARSHAL_TABLE_SIZE ] =
{
    {
        VARIANT_UserSize,
        VARIANT_UserMarshal,
        VARIANT_UserUnmarshal,
        VARIANT_UserFree
    }
};

#if !defined(__RPC_WIN64__)
#error Invalid build platform for this stub.
#endif

static const MIDL_PROC_FORMAT_STRING __MIDL_ProcFormatString =
{
    0,
    {
        /* Procedure NewOrder */

        0x33, /* FC_AUTO_HANDLE */
        0x6c, /* Old Flags: object, Oi2 */

        /* 2 */ NdrFcLong( 0x0 ), /* 0 */
        /* 6 */ NdrFcShort( 0x3 ), /* 3 */
#ifdef _ALPHA_
        /* 8 */ NdrFcShort( 0x38 ), /* ia64 Stack size/offset = 56 */
#else
        NdrFcShort( 0x30 ), /* axp64 Stack size/offset = 48 */
#endif
        /* 10 */ NdrFcShort( 0x0 ), /* 0 */
        /* 12 */ NdrFcShort( 0x8 ), /* 8 */
        /* 14 */ 0x47, /* Oi2 Flags: srv must size, clt must size, has return, has ext, */
        /* 16 */ 0xa, 0x3, /* 3 */
        /* 18 */ 0x10, /* 10 */
        /* 20 */ 0x7, /* Ext Flags: new corr desc, clt corr check, srv corr check, */
        /* 22 */ NdrFcShort( 0x20 ), /* 32 */
        /* 24 */ NdrFcShort( 0x20 ), /* 32 */
    }
};
```

```
/* 22 */ NdrFcShort( 0x0 ), /* 0 */
/* 24 */ NdrFcShort( 0x0 ), /* 0 */

/* Parameter txn_in */

/* 26 */ NdrFcShort( 0x8b ), /* Flags: must size, must free, in, by val, */
#ifdef _ALPHA_
/* 28 */ NdrFcShort( 0x10 ), /* ia64 Stack size/offset = 16 */
#else
NdrFcShort( 0x8 ), /* axp64 Stack size/offset = 8 */
#endif
/* 30 */ NdrFcShort( 0x3b6 ), /* Type Offset=950 */

/* Parameter txn_out */

/* 32 */ NdrFcShort( 0x6113 ), /* Flags: must size, must free, out, simple ref, srv alloc size=24 */
#ifdef _ALPHA_
/* 34 */ NdrFcShort( 0x28 ), /* ia64 Stack size/offset = 40 */
#else
NdrFcShort( 0x20 ), /* axp64 Stack size/offset = 32 */
#endif
/* 36 */ NdrFcShort( 0x3c8 ), /* Type Offset=968 */

/* Return value */

/* 38 */ NdrFcShort( 0x70 ), /* Flags: out, return, base type, */
#ifdef _ALPHA_
/* 40 */ NdrFcShort( 0x30 ), /* ia64 Stack size/offset = 48 */
#else
NdrFcShort( 0x28 ), /* axp64 Stack size/offset = 40 */
#endif
/* 42 */ 0x8, /* FC_LONG */
0x0, /* 0 */

/* Procedure Payment */

/* 44 */ 0x33, /* FC_AUTO_HANDLE */
0x6c, /* Old Flags: object, Oi2 */

/* 46 */ NdrFcLong( 0x0 ), /* 0 */
/* 50 */ NdrFcShort( 0x4 ), /* 4 */
#ifdef _ALPHA_
/* 52 */ NdrFcShort( 0x38 ), /* ia64 Stack size/offset = 56 */
#else
NdrFcShort( 0x30 ), /* axp64 Stack size/offset = 48 */
#endif
/* 54 */ NdrFcShort( 0x0 ), /* 0 */
/* 56 */ NdrFcShort( 0x8 ), /* 8 */
/* 58 */ 0x47, /* Oi2 Flags: srv must size, clt must size, has return, has ext, */
/* 60 */ 0xa, 0x3, /* 3 */
0x7, /* 10 */
/* Ext Flags: new corr desc, clt corr check, srv corr check, */
/* 62 */ NdrFcShort( 0x20 ), /* 32 */
/* 64 */ NdrFcShort( 0x20 ), /* 32 */
/* 66 */ NdrFcShort( 0x0 ), /* 0 */
/* 68 */ NdrFcShort( 0x0 ), /* 0 */

/* Parameter txn_in */

/* 70 */ NdrFcShort( 0x8b ), /* Flags: must size, must free, in, by val, */
#ifdef _ALPHA_
```

Appendix A - Application Source Code

```
/* 72 */ NdrFcShort( 0x10 ),/* ia64 Stack size/offset = 16 */
#else
                NdrFcShort( 0x8 ), /* axp64 Stack size/offset = 8 */
#endif
/* 74 */ NdrFcShort( 0x3b6 ), /* Type Offset=950 */

        /* Parameter txn_out */

/* 76 */ NdrFcShort( 0x6113 ), /* Flags: must size, must free, out, simple ref,
srv alloc size=24 */
#ifdef _ALPHA_
/* 78 */ NdrFcShort( 0x28 ),/* ia64 Stack size/offset = 40 */
#else
                NdrFcShort( 0x20 ),/* axp64 Stack size/offset = 32 */
#endif
/* 80 */ NdrFcShort( 0x3c8 ), /* Type Offset=968 */

        /* Return value */

/* 82 */ NdrFcShort( 0x70 ),/* Flags: out, return, base type, */
#ifdef _ALPHA_
/* 84 */ NdrFcShort( 0x30 ),/* ia64 Stack size/offset = 48 */
#else
                NdrFcShort( 0x28 ),/* axp64 Stack size/offset = 40 */
#endif
/* 86 */ 0x8, /* FC_LONG */
        0x0, /* 0 */

        /* Procedure Delivery */

/* 88 */ 0x33, /* FC_AUTO_HANDLE */
        0x6c, /* Old Flags: object, Oi2 */
/* 90 */ NdrFcLong( 0x0 ), /* 0 */
/* 94 */ NdrFcShort( 0x5 ), /* 5 */
#ifdef _ALPHA_
/* 96 */ NdrFcShort( 0x38 ),/* ia64 Stack size/offset = 56 */
#else
                NdrFcShort( 0x30 ),/* axp64 Stack size/offset = 48 */
#endif
/* 98 */ NdrFcShort( 0x0 ), /* 0 */
/* 100 */ NdrFcShort( 0x8 ), /* 8 */
/* 102 */ 0x47, /* Oi2 Flags: srv must size, clt must size, has return,
has ext, */
        0x3, /* 3 */
/* 104 */ 0xa, /* 10 */
        0x7, /* Ext Flags: new corr desc, clt corr
check, srv corr check, */
/* 106 */ NdrFcShort( 0x20 ),/* 32 */
/* 108 */ NdrFcShort( 0x20 ),/* 32 */
/* 110 */ NdrFcShort( 0x0 ), /* 0 */
/* 112 */ NdrFcShort( 0x0 ), /* 0 */

        /* Parameter txn_in */

/* 114 */ NdrFcShort( 0x8b ),/* Flags: must size, must free, in, by val, */
#ifdef _ALPHA_
/* 116 */ NdrFcShort( 0x10 ),/* ia64 Stack size/offset = 16 */
#else
                NdrFcShort( 0x8 ), /* axp64 Stack size/offset = 8 */
#endif
/* 118 */ NdrFcShort( 0x3b6 ), /* Type Offset=950 */

        /* Parameter txn_out */
```

```
/* 120 */ NdrFcShort( 0x6113 ), /* Flags: must size, must free, out, simple ref,
srv alloc size=24 */
#ifdef _ALPHA_
/* 122 */ NdrFcShort( 0x28 ),/* ia64 Stack size/offset = 40 */
#else
                NdrFcShort( 0x20 ),/* axp64 Stack size/offset = 32 */
#endif
/* 124 */ NdrFcShort( 0x3c8 ), /* Type Offset=968 */

        /* Return value */

/* 126 */ NdrFcShort( 0x70 ),/* Flags: out, return, base type, */
#ifdef _ALPHA_
/* 128 */ NdrFcShort( 0x30 ),/* ia64 Stack size/offset = 48 */
#else
                NdrFcShort( 0x28 ),/* axp64 Stack size/offset = 40 */
#endif
/* 130 */ 0x8, /* FC_LONG */
        0x0, /* 0 */

        /* Procedure StockLevel */

/* 132 */ 0x33, /* FC_AUTO_HANDLE */
        0x6c, /* Old Flags: object, Oi2 */
/* 134 */ NdrFcLong( 0x0 ), /* 0 */
/* 138 */ NdrFcShort( 0x6 ), /* 6 */
#ifdef _ALPHA_
/* 140 */ NdrFcShort( 0x38 ),/* ia64 Stack size/offset = 56 */
#else
                NdrFcShort( 0x30 ),/* axp64 Stack size/offset = 48 */
#endif
/* 142 */ NdrFcShort( 0x0 ), /* 0 */
/* 144 */ NdrFcShort( 0x8 ), /* 8 */
/* 146 */ 0x47, /* Oi2 Flags: srv must size, clt must size, has return,
has ext, */
        0x3, /* 3 */
/* 148 */ 0xa, /* 10 */
        0x7, /* Ext Flags: new corr desc, clt corr
check, srv corr check, */
/* 150 */ NdrFcShort( 0x20 ),/* 32 */
/* 152 */ NdrFcShort( 0x20 ),/* 32 */
/* 154 */ NdrFcShort( 0x0 ), /* 0 */
/* 156 */ NdrFcShort( 0x0 ), /* 0 */

        /* Parameter txn_in */

/* 158 */ NdrFcShort( 0x8b ),/* Flags: must size, must free, in, by val, */
#ifdef _ALPHA_
/* 160 */ NdrFcShort( 0x10 ),/* ia64 Stack size/offset = 16 */
#else
                NdrFcShort( 0x8 ), /* axp64 Stack size/offset = 8 */
#endif
/* 162 */ NdrFcShort( 0x3b6 ), /* Type Offset=950 */

        /* Parameter txn_out */

/* 164 */ NdrFcShort( 0x6113 ), /* Flags: must size, must free, out, simple ref,
srv alloc size=24 */
#ifdef _ALPHA_
/* 166 */ NdrFcShort( 0x28 ),/* ia64 Stack size/offset = 40 */
#else
                NdrFcShort( 0x20 ),/* axp64 Stack size/offset = 32 */
```

Appendix A - Application Source Code

```
#endif
/* 168 */NdrFcShort( 0x3c8 ), /* Type Offset=968 */

/* Return value */

/* 170 */NdrFcShort( 0x70 ),/* Flags: out, return, base type, */
#ifdef _ALPHA_
/* 172 */NdrFcShort( 0x30 ),/* ia64 Stack size/offset = 48 */
#else
NdrFcShort( 0x28 ),/* axp64 Stack size/offset = 40 */
#endif
/* 174 */0x8, /* FC_LONG */
0x0, /* 0 */

/* Procedure OrderStatus */

/* 176 */0x33, /* FC_AUTO_HANDLE */
0x6c, /* Old Flags: object, Oi2 */
/* 178 */NdrFcLong( 0x0 ), /* 0 */
/* 182 */NdrFcShort( 0x7 ), /* 7 */
#ifdef _ALPHA_
/* 184 */NdrFcShort( 0x38 ),/* ia64 Stack size/offset = 56 */
#else
NdrFcShort( 0x30 ),/* axp64 Stack size/offset = 48 */
#endif
/* 186 */NdrFcShort( 0x0 ), /* 0 */
/* 188 */NdrFcShort( 0x8 ), /* 8 */
/* 190 */0x47, /* Oi2 Flags: srv must size, clt must size, has return,
has ext, */
0x3, /* 3 */
/* 192 */0xa, /* 10 */
0x7, /* Ext Flags: new corr desc, clt corr
check, srv corr check, */
/* 194 */NdrFcShort( 0x20 ),/* 32 */
/* 196 */NdrFcShort( 0x20 ),/* 32 */
/* 198 */NdrFcShort( 0x0 ), /* 0 */
/* 200 */NdrFcShort( 0x0 ), /* 0 */

/* Parameter txn_in */

/* 202 */NdrFcShort( 0x8b ),/* Flags: must size, must free, in, by val, */
#ifdef _ALPHA_
/* 204 */NdrFcShort( 0x10 ),/* ia64 Stack size/offset = 16 */
#else
NdrFcShort( 0x8 ), /* axp64 Stack size/offset = 8 */
#endif
/* 206 */NdrFcShort( 0x3b6 ), /* Type Offset=950 */

/* Parameter txn_out */

/* 208 */NdrFcShort( 0x6113 ), /* Flags: must size, must free, out, simple ref,
srv alloc size=24 */
#ifdef _ALPHA_
/* 210 */NdrFcShort( 0x28 ),/* ia64 Stack size/offset = 40 */
#else
NdrFcShort( 0x20 ),/* axp64 Stack size/offset = 32 */
#endif
/* 212 */NdrFcShort( 0x3c8 ), /* Type Offset=968 */

/* Return value */

/* 214 */NdrFcShort( 0x70 ),/* Flags: out, return, base type, */
#ifdef _ALPHA_
```

```
/* 216 */NdrFcShort( 0x30 ),/* ia64 Stack size/offset = 48 */
#else
NdrFcShort( 0x28 ),/* axp64 Stack size/offset = 40 */
#endif
/* 218 */0x8, /* FC_LONG */
0x0, /* 0 */

/* Procedure CallSetComplete */

/* 220 */0x33, /* FC_AUTO_HANDLE */
0x6c, /* Old Flags: object, Oi2 */
/* 222 */NdrFcLong( 0x0 ), /* 0 */
/* 226 */NdrFcShort( 0x8 ), /* 8 */
/* 228 */NdrFcShort( 0x10 ),/* ia64, axp64 Stack size/offset = 16 */
/* 230 */NdrFcShort( 0x0 ), /* 0 */
/* 232 */NdrFcShort( 0x8 ), /* 8 */
/* 234 */0x44, /* Oi2 Flags: has return, has ext, */
0x1, /* 1 */
/* 236 */0xa, /* 10 */
0x1, /* Ext Flags: new corr desc, */
/* 238 */NdrFcShort( 0x0 ), /* 0 */
/* 240 */NdrFcShort( 0x0 ), /* 0 */
/* 242 */NdrFcShort( 0x0 ), /* 0 */
/* 244 */NdrFcShort( 0x0 ), /* 0 */

/* Return value */

/* 246 */NdrFcShort( 0x70 ),/* Flags: out, return, base type, */
/* 248 */NdrFcShort( 0x8 ), /* ia64, axp64 Stack size/offset = 8 */
/* 250 */0x8, /* FC_LONG */
0x0, /* 0 */

0x0

};

static const MIDL_TYPE_FORMAT_STRING __MIDL_TypeFormatString =
{
0,
{
/* 2 */NdrFcShort( 0x0 ), /* 0 */
/* 4 */NdrFcShort( 0x39e ), /* Offset= 926 (930) */
/* 6 */
0x2b, /* FC_NON_ENCAPSULATED_UNION */
0x9, /* FC_ULONG */
/* 8 */0x7, /* Corr desc: FC_USHORT */
0x0, /* */
/* 10 */NdrFcShort( 0xffff8 ), /* -8 */
/* 12 */NdrFcShort( 0x1 ), /* Corr flags: early, */
/* 14 */NdrFcShort( 0x2 ), /* Offset= 2 (16) */
/* 16 */NdrFcShort( 0x10 ), /* 16 */
/* 18 */NdrFcShort( 0x2b ), /* 43 */
/* 20 */NdrFcLong( 0x3 ), /* 3 */
/* 24 */NdrFcShort( 0x8008 ), /* Simple arm type: FC_LONG */
/* 26 */NdrFcLong( 0x11 ), /* 17 */
/* 30 */NdrFcShort( 0x8001 ), /* Simple arm type: FC_BYTE */
/* 32 */NdrFcLong( 0x2 ), /* 2 */
/* 36 */NdrFcShort( 0x8006 ), /* Simple arm type: FC_SHORT */
/* 38 */NdrFcLong( 0x4 ), /* 4 */
/* 42 */NdrFcShort( 0x800a ), /* Simple arm type: FC_FLOAT */
/* 44 */NdrFcLong( 0x5 ), /* 5 */
```

Appendix A - Application Source Code

```
/* 48 */ NdrFcShort( 0x800c ), /* Simple arm type: FC_DOUBLE */
/* 50 */ NdrFcLong( 0xb ), /* 11 */
/* 54 */ NdrFcShort( 0x8006 ), /* Simple arm type: FC_SHORT */
/* 56 */ NdrFcLong( 0xa ), /* 10 */
/* 60 */ NdrFcShort( 0x8008 ), /* Simple arm type: FC_LONG */
/* 62 */ NdrFcLong( 0x6 ), /* 6 */
/* 66 */ NdrFcShort( 0xd6 ), /* Offset= 214 (280) */
/* 68 */ NdrFcLong( 0x7 ), /* 7 */
/* 72 */ NdrFcShort( 0x800c ), /* Simple arm type: FC_DOUBLE */
/* 74 */ NdrFcLong( 0x8 ), /* 8 */
/* 78 */ NdrFcShort( 0xd0 ), /* Offset= 208 (286) */
/* 80 */ NdrFcLong( 0xd ), /* 13 */
/* 84 */ NdrFcShort( 0xe4 ), /* Offset= 228 (312) */
/* 86 */ NdrFcLong( 0x9 ), /* 9 */
/* 90 */ NdrFcShort( 0xf0 ), /* Offset= 240 (330) */
/* 92 */ NdrFcLong( 0x2000 ), /* 8192 */
/* 96 */ NdrFcShort( 0xfc ), /* Offset= 252 (348) */
/* 98 */ NdrFcLong( 0x24 ), /* 36 */
/* 102 */ NdrFcShort( 0x2f4 ), /* Offset= 756 (858) */
/* 104 */ NdrFcLong( 0x4024 ), /* 16420 */
/* 108 */ NdrFcShort( 0x2ee ), /* Offset= 750 (858) */
/* 110 */ NdrFcLong( 0x4011 ), /* 16401 */
/* 114 */ NdrFcShort( 0x2ec ), /* Offset= 748 (862) */
/* 116 */ NdrFcLong( 0x4002 ), /* 16386 */
/* 120 */ NdrFcShort( 0x2ea ), /* Offset= 746 (866) */
/* 122 */ NdrFcLong( 0x4003 ), /* 16387 */
/* 126 */ NdrFcShort( 0x2e8 ), /* Offset= 744 (870) */
/* 128 */ NdrFcLong( 0x4004 ), /* 16388 */
/* 132 */ NdrFcShort( 0x2e6 ), /* Offset= 742 (874) */
/* 134 */ NdrFcLong( 0x4005 ), /* 16389 */
/* 138 */ NdrFcShort( 0x2e4 ), /* Offset= 740 (878) */
/* 140 */ NdrFcLong( 0x400b ), /* 16395 */
/* 144 */ NdrFcShort( 0x2d2 ), /* Offset= 722 (866) */
/* 146 */ NdrFcLong( 0x400a ), /* 16394 */
/* 150 */ NdrFcShort( 0x2d0 ), /* Offset= 720 (870) */
/* 152 */ NdrFcLong( 0x4006 ), /* 16390 */
/* 156 */ NdrFcShort( 0x2d6 ), /* Offset= 726 (882) */
/* 158 */ NdrFcLong( 0x4007 ), /* 16391 */
/* 162 */ NdrFcShort( 0x2cc ), /* Offset= 716 (878) */
/* 164 */ NdrFcLong( 0x4008 ), /* 16392 */
/* 168 */ NdrFcShort( 0x2ce ), /* Offset= 718 (886) */
/* 170 */ NdrFcLong( 0x400d ), /* 16397 */
/* 174 */ NdrFcShort( 0x2cc ), /* Offset= 716 (890) */
/* 176 */ NdrFcLong( 0x4009 ), /* 16393 */
/* 180 */ NdrFcShort( 0x2ca ), /* Offset= 714 (894) */
/* 182 */ NdrFcLong( 0x6000 ), /* 24576 */
/* 186 */ NdrFcShort( 0x2c8 ), /* Offset= 712 (898) */
/* 188 */ NdrFcLong( 0x400c ), /* 16396 */
/* 192 */ NdrFcShort( 0x2c6 ), /* Offset= 710 (902) */
/* 194 */ NdrFcLong( 0x10 ), /* 16 */
/* 198 */ NdrFcShort( 0x8002 ), /* Simple arm type: FC_CHAR */
/* 200 */ NdrFcLong( 0x12 ), /* 18 */
/* 204 */ NdrFcShort( 0x8006 ), /* Simple arm type: FC_SHORT */
/* 206 */ NdrFcLong( 0x13 ), /* 19 */
/* 210 */ NdrFcShort( 0x8008 ), /* Simple arm type: FC_LONG */
/* 212 */ NdrFcLong( 0x16 ), /* 22 */
/* 216 */ NdrFcShort( 0x8008 ), /* Simple arm type: FC_LONG */
/* 218 */ NdrFcLong( 0x17 ), /* 23 */
/* 222 */ NdrFcShort( 0x8008 ), /* Simple arm type: FC_LONG */
/* 224 */ NdrFcLong( 0xe ), /* 14 */
/* 228 */ NdrFcShort( 0x2aa ), /* Offset= 682 (910) */
/* 230 */ NdrFcLong( 0x400e ), /* 16398 */
/* 234 */ NdrFcShort( 0x2b0 ), /* Offset= 688 (922) */
```

```
/* 236 */ NdrFcLong( 0x4010 ), /* 16400 */
/* 240 */ NdrFcShort( 0x2ae ), /* Offset= 686 (926) */
/* 242 */ NdrFcLong( 0x4012 ), /* 16402 */
/* 246 */ NdrFcShort( 0x26c ), /* Offset= 620 (866) */
/* 248 */ NdrFcLong( 0x4013 ), /* 16403 */
/* 252 */ NdrFcShort( 0x26a ), /* Offset= 618 (870) */
/* 254 */ NdrFcLong( 0x4016 ), /* 16406 */
/* 258 */ NdrFcShort( 0x264 ), /* Offset= 612 (870) */
/* 260 */ NdrFcLong( 0x4017 ), /* 16407 */
/* 264 */ NdrFcShort( 0x25e ), /* Offset= 606 (870) */
/* 266 */ NdrFcLong( 0x0 ), /* 0 */
/* 270 */ NdrFcShort( 0x0 ), /* Offset= 0 (270) */
/* 272 */ NdrFcLong( 0x1 ), /* 1 */
/* 276 */ NdrFcShort( 0x0 ), /* Offset= 0 (276) */
/* 278 */ NdrFcShort( 0xffffffff ), /* Offset= -1 (277) */
/* 280 */
/* 282 */ NdrFcShort( 0x8 ), /* 8 */
/* 284 */ 0xb, /* FC_HYPER */
/* 286 */
/* 288 */ NdrFcShort( 0xe ), /* Offset= 14 (302) */
/* 290 */
/* 292 */ NdrFcShort( 0x2 ), /* 2 */
/* 294 */ 0x9, /* Corr desc: FC_ULONG */
/* 296 */ NdrFcShort( 0xfffc ), /* -4 */
/* 298 */ NdrFcShort( 0x1 ), /* Corr flags: early, */
/* 300 */ 0x6, /* FC_SHORT */
/* 302 */
/* 304 */ NdrFcShort( 0x8 ), /* 8 */
/* 306 */ NdrFcShort( 0xffffffff0 ), /* Offset= -16 (290) */
/* 308 */ 0x8, /* FC_LONG */
/* 310 */ 0x5c, /* FC_PAD */
/* 312 */
/* 314 */ NdrFcLong( 0x0 ), /* 0 */
/* 318 */ NdrFcShort( 0x0 ), /* 0 */
/* 320 */ NdrFcShort( 0x0 ), /* 0 */
/* 322 */ 0xc0, /* 192 */
/* 324 */ 0x0, /* 0 */
/* 326 */ 0x0, /* 0 */
/* 328 */ 0x0, /* 0 */
/* 330 */
/* 332 */ NdrFcLong( 0x20400 ), /* 132096 */
/* 336 */ NdrFcShort( 0x0 ), /* 0 */
/* 338 */ NdrFcShort( 0x0 ), /* 0 */
```

Appendix A - Application Source Code

```
/* 340 */ 0xc0, /* 192 */
/* 342 */ 0x0, /* 0 */
/* 344 */ 0x0, /* 0 */
/* 346 */ 0x0, /* 0 */
/* 348 */ 0x46, /* 70 */
/* 350 */ NdrFcShort( 0x2 ), /* FC_UP [pointer_deref] */
/* 352 */ /* Offset= 2 (352) */
/* 354 */ NdrFcShort( 0x1e6 ), /* FC_UP */
/* 356 */ /* Offset= 486 (840) */
/* 358 */ 0x2a, /* FC_ENCAPSULATED_UNION */
/* 360 */ 0x89, /* 137 */
/* 362 */ NdrFcShort( 0x20 ), /* 32 */
/* 364 */ NdrFcShort( 0xa ), /* 10 */
/* 366 */ NdrFcLong( 0x8 ), /* 8 */
/* 368 */ NdrFcShort( 0x50 ), /* Offset= 80 (446) */
/* 370 */ NdrFcLong( 0xd ), /* 13 */
/* 372 */ NdrFcShort( 0x70 ), /* Offset= 112 (484) */
/* 374 */ NdrFcLong( 0x9 ), /* 9 */
/* 376 */ NdrFcShort( 0x90 ), /* Offset= 144 (522) */
/* 378 */ NdrFcLong( 0xc ), /* 12 */
/* 380 */ NdrFcShort( 0xb0 ), /* Offset= 176 (560) */
/* 382 */ NdrFcLong( 0x24 ), /* 36 */
/* 384 */ NdrFcShort( 0x104 ), /* Offset= 260 (650) */
/* 386 */ NdrFcLong( 0x800d ), /* 32781 */
/* 388 */ NdrFcShort( 0x120 ), /* Offset= 288 (684) */
/* 390 */ NdrFcLong( 0x10 ), /* 16 */
/* 392 */ NdrFcShort( 0x13a ), /* Offset= 314 (716) */
/* 394 */ NdrFcLong( 0x2 ), /* 2 */
/* 396 */ NdrFcShort( 0x150 ), /* Offset= 336 (744) */
/* 398 */ NdrFcLong( 0x3 ), /* 3 */
/* 400 */ NdrFcShort( 0x166 ), /* Offset= 358 (772) */
/* 402 */ NdrFcLong( 0x14 ), /* 20 */
/* 404 */ NdrFcShort( 0x17c ), /* Offset= 380 (800) */
/* 406 */ NdrFcShort( 0xffffffff ), /* Offset= -1 (421) */
/* 408 */
/* 410 */ 0x21, /* FC_BOGUS_ARRAY */
/* 412 */ 0x3, /* 3 */
/* 414 */ NdrFcShort( 0x0 ), /* 0 */
/* 416 */ 0x19, /* Corr desc: field pointer, FC_ULONG */
/* 418 */ 0x0, /* */
/* 420 */ NdrFcShort( 0x0 ), /* 0 */
/* 422 */ NdrFcShort( 0x1 ), /* Corr flags: early, */
/* 424 */ NdrFcLong( 0xffffffff ), /* -1 */
/* 426 */ NdrFcShort( 0x0 ), /* Corr flags: */
/* 428 */
/* 430 */ 0x12, 0x0, /* FC_UP */
/* 432 */ NdrFcShort( 0xfffff74 ), /* Offset= -140 (302) */
/* 434 */ 0x5c, /* FC_PAD */
/* 436 */ 0x5b, /* FC_END */
/* 438 */
/* 440 */ 0x1a, /* FC_BOGUS_STRUCT */
/* 442 */ 0x3, /* 3 */
/* 444 */ NdrFcShort( 0x10 ), /* 16 */
/* 446 */ NdrFcShort( 0x0 ), /* 0 */
/* 448 */ NdrFcShort( 0x6 ), /* Offset= 6 (458) */
/* 450 */ 0x8, /* FC_LONG */
/* 452 */ 0x39, /* FC_ALIGNM8 */
```

```
/* 454 */ 0x36, /* FC_POINTER */
/* 456 */ 0x5b, /* FC_END */
/* 458 */
/* 460 */ 0x11, 0x0, /* FC_RP */
/* 462 */ NdrFcShort( 0xfffffddc ), /* Offset= -36 (424) */
/* 464 */
/* 466 */ 0x21, /* FC_BOGUS_ARRAY */
/* 468 */ 0x3, /* 3 */
/* 470 */ NdrFcShort( 0x0 ), /* 0 */
/* 472 */ 0x19, /* Corr desc: field pointer, FC_ULONG */
/* 474 */ 0x0, /* */
/* 476 */ NdrFcShort( 0x0 ), /* 0 */
/* 478 */ NdrFcShort( 0x1 ), /* Corr flags: early, */
/* 480 */ NdrFcLong( 0xffffffff ), /* -1 */
/* 482 */ NdrFcShort( 0x0 ), /* Corr flags: */
/* 484 */ 0x4c, /* FC_EMBEDDED_COMPLEX */
/* 486 */ 0x0, /* 0 */
/* 488 */ NdrFcShort( 0xfffff58 ), /* Offset= -168 (312) */
/* 490 */ 0x5c, /* FC_PAD */
/* 492 */ 0x5b, /* FC_END */
/* 494 */
/* 496 */ 0x1a, /* FC_BOGUS_STRUCT */
/* 498 */ 0x3, /* 3 */
/* 500 */ NdrFcShort( 0x10 ), /* 16 */
/* 502 */ NdrFcShort( 0x0 ), /* 0 */
/* 504 */ 0x19, /* Corr desc: field pointer, FC_ULONG */
/* 506 */ 0x0, /* */
/* 508 */ NdrFcShort( 0x0 ), /* 0 */
/* 510 */ NdrFcShort( 0x1 ), /* Corr flags: early, */
/* 512 */ NdrFcLong( 0xffffffff ), /* -1 */
/* 514 */ NdrFcShort( 0x0 ), /* Corr flags: */
/* 516 */ 0x4c, /* FC_EMBEDDED_COMPLEX */
/* 518 */ 0x0, /* 0 */
/* 520 */ NdrFcShort( 0xfffff44 ), /* Offset= -188 (330) */
/* 522 */ 0x5c, /* FC_PAD */
/* 524 */ 0x5b, /* FC_END */
/* 526 */
/* 528 */ 0x1a, /* FC_BOGUS_STRUCT */
/* 530 */ 0x3, /* 3 */
/* 532 */ NdrFcShort( 0x10 ), /* 16 */
/* 534 */ NdrFcShort( 0x0 ), /* 0 */
/* 536 */ NdrFcShort( 0x6 ), /* Offset= 6 (534) */
/* 538 */ 0x8, /* FC_LONG */
/* 540 */ 0x39, /* FC_ALIGNM8 */
/* 542 */ 0x36, /* FC_POINTER */
/* 544 */ 0x5b, /* FC_END */
/* 546 */
/* 548 */ 0x11, 0x0, /* FC_RP */
/* 550 */ NdrFcShort( 0xfffffddc ), /* Offset= -36 (500) */
/* 552 */
/* 554 */ 0x21, /* FC_BOGUS_ARRAY */
```

Appendix A - Application Source Code

```
/* 540 */NdrFcShort( 0x0 ), /* 0 */
/* 542 */0x19, /* Corr desc: field pointer, FC_ULONG */
/* 544 */NdrFcShort( 0x0 ), /* 0 */
/* 546 */NdrFcShort( 0x1 ), /* Corr flags: early, */
/* 548 */NdrFcLong( 0xffffffff ), /* -1 */
/* 552 */NdrFcShort( 0x0 ), /* Corr flags: */
/* 554 */
/* 556 */NdrFcShort( 0x12, 0x0, /* FC_UP */
/* 558 */0x5c, /* Offset= 374 (930) */
/* 560 */0x5b, /* FC_PAD */
/* 562 */0x1a, /* FC_BOGUS_STRUCT */
/* 564 */0x3, /* 3 */
/* 566 */NdrFcShort( 0x10 ), /* 16 */
/* 568 */NdrFcShort( 0x0 ), /* 0 */
/* 570 */NdrFcShort( 0x6 ), /* Offset= 6 (572) */
/* 572 */0x8, /* FC_LONG */
/* 574 */0x39, /* FC_ALIGNM8 */
/* 576 */0x36, /* FC_POINTER */
/* 578 */0x5b, /* FC_END */
/* 580 */0x11, 0x0, /* FC_RP */
/* 582 */NdrFcShort( 0xffffffffdc ), /* Offset= -36 (538) */
/* 584 */0x2f, /* FC_IP */
/* 586 */0x5a, /* FC_CONSTANT_IID */
/* 588 */NdrFcLong( 0x2f ), /* 47 */
/* 590 */NdrFcShort( 0x0 ), /* 0 */
/* 592 */NdrFcShort( 0x0 ), /* 0 */
/* 594 */NdrFcShort( 0x0 ), /* 0 */
/* 596 */NdrFcShort( 0x0 ), /* 0 */
/* 598 */NdrFcShort( 0x0 ), /* 0 */
/* 600 */NdrFcShort( 0x0 ), /* 0 */
/* 602 */NdrFcShort( 0x0 ), /* 0 */
/* 604 */NdrFcShort( 0x0 ), /* 0 */
/* 606 */NdrFcShort( 0x46, /* 70 */
/* 608 */0x1b, /* FC_CARRAY */
/* 610 */0x0, /* 0 */
/* 612 */NdrFcShort( 0x1 ), /* 1 */
/* 614 */NdrFcShort( 0x19, /* Corr desc: field pointer, FC_ULONG */
/* 616 */0x0, /* 0 */
/* 618 */NdrFcShort( 0x4 ), /* 4 */
/* 620 */NdrFcShort( 0x1 ), /* Corr flags: early, */
/* 622 */NdrFcShort( 0x1 ), /* FC_BYTE */
/* 624 */0x5b, /* FC_END */
/* 626 */0x1a, /* FC_BOGUS_STRUCT */
/* 628 */0x3, /* 3 */
/* 630 */NdrFcShort( 0x18 ), /* 24 */
/* 632 */NdrFcShort( 0x0 ), /* 0 */
/* 634 */NdrFcShort( 0xc ), /* Offset= 12 (624) */
/* 636 */0x8, /* FC_LONG */
/* 638 */0x8, /* FC_LONG */
/* 640 */0x4c, /* FC_EMBEDDED_COMPLEX */
/* 642 */0x0, /* 0 */
/* 644 */NdrFcShort( 0xffffffffd6 ), /* Offset= -42 (576) */
/* 646 */0x39, /* FC_ALIGNM8 */
/* 648 */0x36, /* FC_POINTER */
```

```
/* 622 */0x5c, /* FC_PAD */
/* 624 */0x5b, /* FC_END */
/* 626 */0x12, 0x0, /* FC_UP */
/* 628 */NdrFcShort( 0xffffffffe0 ), /* Offset= -32 (594) */
/* 630 */0x21, /* FC_BOGUS_ARRAY */
/* 632 */0x3, /* 3 */
/* 634 */NdrFcShort( 0x0 ), /* 0 */
/* 636 */NdrFcShort( 0x19, /* Corr desc: field pointer, FC_ULONG */
/* 638 */0x0, /* 0 */
/* 640 */NdrFcShort( 0x0 ), /* 0 */
/* 642 */NdrFcShort( 0x1 ), /* Corr flags: early, */
/* 644 */NdrFcLong( 0xffffffff ), /* -1 */
/* 646 */NdrFcShort( 0x0 ), /* Corr flags: */
/* 648 */0x12, 0x0, /* FC_UP */
/* 650 */NdrFcShort( 0xffffffffd8 ), /* Offset= -40 (606) */
/* 652 */0x5c, /* FC_PAD */
/* 654 */0x5b, /* FC_END */
/* 656 */0x1a, /* FC_BOGUS_STRUCT */
/* 658 */0x3, /* 3 */
/* 660 */NdrFcShort( 0x10 ), /* 16 */
/* 662 */NdrFcShort( 0x0 ), /* 0 */
/* 664 */NdrFcShort( 0x6 ), /* Offset= 6 (662) */
/* 666 */0x8, /* FC_LONG */
/* 668 */0x39, /* FC_ALIGNM8 */
/* 670 */0x36, /* FC_POINTER */
/* 672 */0x5b, /* FC_END */
/* 674 */0x11, 0x0, /* FC_RP */
/* 676 */NdrFcShort( 0xffffffffdc ), /* Offset= -36 (628) */
/* 678 */0x1d, /* FC_SMFARRAY */
/* 680 */0x0, /* 0 */
/* 682 */NdrFcShort( 0x8 ), /* 8 */
/* 684 */0x2, /* FC_CHAR */
/* 686 */0x5b, /* FC_END */
/* 688 */0x15, /* FC_STRUCT */
/* 690 */0x3, /* 3 */
/* 692 */NdrFcShort( 0x10 ), /* 16 */
/* 694 */0x8, /* FC_LONG */
/* 696 */0x6, /* FC_SHORT */
/* 698 */0x6, /* FC_SHORT */
/* 700 */0x4c, /* FC_EMBEDDED_COMPLEX */
/* 702 */0x0, /* 0 */
/* 704 */NdrFcShort( 0xfffffffff1 ), /* Offset= -15 (666) */
/* 706 */0x5b, /* FC_END */
/* 708 */0x1a, /* FC_BOGUS_STRUCT */
/* 710 */0x3, /* 3 */
/* 712 */NdrFcShort( 0x20 ), /* 32 */
/* 714 */NdrFcShort( 0x0 ), /* 0 */
/* 716 */NdrFcShort( 0xa ), /* Offset= 10 (700) */
/* 718 */0x8, /* FC_LONG */
/* 720 */0x8, /* FC_LONG */
/* 722 */0x39, /* FC_ALIGNM8 */
/* 724 */0x36, /* FC_POINTER */
/* 726 */0x4c, /* FC_EMBEDDED_COMPLEX */
/* 728 */0x0, /* 0 */
/* 730 */NdrFcShort( 0xffffffffe7 ), /* Offset= -25 (672) */
/* 732 */0x5b, /* FC_END */
```

Appendix A - Application Source Code

```
/* 700 */
/* 702 */NdrFcShort( 0xfffff10 ), /* Offset= -240 (462) */
/* 704 */
/* 706 */NdrFcShort( 0x1 ), /* 1 */
/* 708 */0x19, /* Corr desc: field pointer, FC_ULONG */
/* 710 */NdrFcShort( 0x0 ), /* 0 */
/* 712 */NdrFcShort( 0x1 ), /* Corr flags: early, */
/* 714 */0x1, /* FC_BYTE */
/* 716 */0x5b, /* FC_END */
/* 718 */NdrFcShort( 0x10 ), /* 16 */
/* 720 */NdrFcShort( 0x0 ), /* 0 */
/* 722 */NdrFcShort( 0x6 ), /* Offset= 6 (728) */
/* 724 */0x8, /* FC_LONG */
/* 726 */0x36, /* FC_POINTER */
/* 728 */0x5b, /* FC_END */
/* 730 */NdrFcShort( 0xfffffe6 ), /* Offset= -26 (704) */
/* 732 */0x1b, /* FC_CARRY */
/* 734 */0x1, /* 1 */
/* 736 */0x19, /* Corr desc: field pointer, FC_ULONG */
/* 738 */NdrFcShort( 0x0 ), /* 0 */
/* 740 */NdrFcShort( 0x1 ), /* Corr flags: early, */
/* 742 */0x6, /* FC_SHORT */
/* 744 */0x5b, /* FC_END */
/* 746 */NdrFcShort( 0x10 ), /* 16 */
/* 748 */NdrFcShort( 0x0 ), /* 0 */
/* 750 */NdrFcShort( 0x6 ), /* Offset= 6 (756) */
/* 752 */0x8, /* FC_LONG */
/* 754 */0x36, /* FC_POINTER */
/* 756 */0x5b, /* FC_END */
/* 758 */NdrFcShort( 0xfffffe6 ), /* Offset= -26 (732) */
/* 760 */0x1b, /* FC_CARRY */
/* 762 */NdrFcShort( 0x4 ), /* 4 */
/* 764 */0x19, /* Corr desc: field pointer, FC_ULONG */
/* 766 */NdrFcShort( 0x0 ), /* 0 */
/* 768 */NdrFcShort( 0x1 ), /* Corr flags: early, */
/* 770 */0x8, /* FC_LONG */
/* 772 */0x5b, /* FC_END */
/* 774 */NdrFcShort( 0x10 ), /* 16 */
/* 776 */NdrFcShort( 0x0 ), /* 0 */
/* 778 */NdrFcShort( 0x6 ), /* Offset= 6 (784) */
/* 780 */0x8, /* FC_LONG */
/* 782 */0x36, /* FC_POINTER */
/* 784 */0x5b, /* FC_END */
/* 786 */NdrFcShort( 0xfffffe6 ), /* Offset= -26 (760) */
/* 788 */0x1b, /* FC_CARRY */
/* 790 */NdrFcShort( 0x8 ), /* 8 */
/* 792 */0x19, /* Corr desc: field pointer, FC_ULONG */
/* 794 */NdrFcShort( 0x0 ), /* 0 */
/* 796 */NdrFcShort( 0x1 ), /* Corr flags: early, */
/* 798 */0xb, /* FC_HYPER */
/* 800 */0x5b, /* FC_END */
/* 802 */NdrFcShort( 0x10 ), /* 16 */
/* 804 */NdrFcShort( 0x0 ), /* 0 */
/* 806 */NdrFcShort( 0x6 ), /* Offset= 6 (812) */
/* 808 */0x8, /* FC_LONG */
/* 810 */0x36, /* FC_POINTER */
/* 812 */0x5b, /* FC_END */
/* 814 */NdrFcShort( 0xfffffe6 ), /* Offset= -26 (788) */
/* 816 */0x15, /* FC_STRUCT */
/* 818 */NdrFcShort( 0x8 ), /* 8 */
/* 820 */0x8, /* FC_LONG */
/* 822 */0x5c, /* FC_PAD */
/* 824 */0x5b, /* FC_END */
/* 826 */NdrFcShort( 0x8 ), /* 8 */
/* 828 */0x7, /* Corr desc: FC_USHORT */
/* 830 */NdrFcShort( 0xffc8 ), /* -56 */
/* 832 */NdrFcShort( 0x1 ), /* Corr flags: early, */
/* 834 */0x4c, /* FC_EMBEDDED_COMPLEX */
/* 836 */NdrFcShort( 0xfffffec ), /* Offset= -20 (816) */
/* 838 */0x5c, /* FC_PAD */
/* 840 */0x5b, /* FC_END */
/* 842 */NdrFcShort( 0x38 ), /* 56 */
/* 844 */NdrFcShort( 0xfffffec ), /* Offset= -20 (824) */
/* 846 */NdrFcShort( 0x0 ), /* Offset= 0 (846) */
/* 848 */0x6, /* FC_SHORT */
/* 850 */0x38, /* FC_ALIGNM4 */
/* 852 */0x8, /* FC_LONG */
```

```
/* 776 */NdrFcShort( 0x0 ), /* 0 */
/* 778 */NdrFcShort( 0x6 ), /* Offset= 6 (784) */
/* 780 */0x8, /* FC_LONG */
/* 782 */0x36, /* FC_POINTER */
/* 784 */0x5b, /* FC_END */
/* 786 */NdrFcShort( 0xfffffe6 ), /* Offset= -26 (760) */
/* 788 */0x1b, /* FC_CARRY */
/* 790 */NdrFcShort( 0x8 ), /* 8 */
/* 792 */0x19, /* Corr desc: field pointer, FC_ULONG */
/* 794 */NdrFcShort( 0x0 ), /* 0 */
/* 796 */NdrFcShort( 0x1 ), /* Corr flags: early, */
/* 798 */0xb, /* FC_HYPER */
/* 800 */0x5b, /* FC_END */
/* 802 */NdrFcShort( 0x10 ), /* 16 */
/* 804 */NdrFcShort( 0x0 ), /* 0 */
/* 806 */NdrFcShort( 0x6 ), /* Offset= 6 (812) */
/* 808 */0x8, /* FC_LONG */
/* 810 */0x36, /* FC_POINTER */
/* 812 */0x5b, /* FC_END */
/* 814 */NdrFcShort( 0xfffffe6 ), /* Offset= -26 (788) */
/* 816 */0x15, /* FC_STRUCT */
/* 818 */NdrFcShort( 0x8 ), /* 8 */
/* 820 */0x8, /* FC_LONG */
/* 822 */0x5c, /* FC_PAD */
/* 824 */0x5b, /* FC_END */
/* 826 */NdrFcShort( 0x8 ), /* 8 */
/* 828 */0x7, /* Corr desc: FC_USHORT */
/* 830 */NdrFcShort( 0xffc8 ), /* -56 */
/* 832 */NdrFcShort( 0x1 ), /* Corr flags: early, */
/* 834 */0x4c, /* FC_EMBEDDED_COMPLEX */
/* 836 */NdrFcShort( 0xfffffec ), /* Offset= -20 (816) */
/* 838 */0x5c, /* FC_PAD */
/* 840 */0x5b, /* FC_END */
/* 842 */NdrFcShort( 0x38 ), /* 56 */
/* 844 */NdrFcShort( 0xfffffec ), /* Offset= -20 (824) */
/* 846 */NdrFcShort( 0x0 ), /* Offset= 0 (846) */
/* 848 */0x6, /* FC_SHORT */
/* 850 */0x38, /* FC_ALIGNM4 */
/* 852 */0x8, /* FC_LONG */
```

Appendix A - Application Source Code

```
/* 852 */ 0x8, /* FC_LONG */
/* 854 */ 0x4, /* FC_EMBEDDED_COMPLEX */
/* 858 */ /* 4 */
/* 860 */ NdrFcShort( 0xfffffe0d ), /* Offset= -499 (356) */
/* 862 */ 0x5b, /* FC_END */
/* 866 */ 0x12, 0x0, /* FC_UP */
/* 870 */ NdrFcShort( 0xfffff02 ), /* Offset= -254 (606) */
/* 874 */ 0x12, 0x8, /* FC_UP [simple_pointer] */
/* 878 */ /* FC_BYTE */
/* 882 */ 0x5c, /* FC_PAD */
/* 886 */ 0x12, 0x8, /* FC_UP [simple_pointer] */
/* 890 */ /* FC_SHORT */
/* 894 */ 0x5c, /* FC_PAD */
/* 898 */ 0x12, 0x8, /* FC_UP [simple_pointer] */
/* 902 */ /* FC_LONG */
/* 906 */ 0x5c, /* FC_PAD */
/* 910 */ 0x12, 0x8, /* FC_UP [simple_pointer] */
/* 914 */ /* FC_FLOAT */
/* 918 */ 0x5c, /* FC_PAD */
/* 922 */ 0x12, 0x8, /* FC_UP [simple_pointer] */
/* 926 */ /* FC_DOUBLE */
/* 930 */ 0x5c, /* FC_PAD */
/* 934 */ 0x12, 0x0, /* FC_UP */
/* 938 */ NdrFcShort( 0xfffffda4 ), /* Offset= -604 (280) */
/* 942 */ 0x12, 0x10, /* FC_UP [pointer_deref] */
/* 946 */ NdrFcShort( 0xfffffda6 ), /* Offset= -602 (286) */
/* 950 */ 0x12, 0x10, /* FC_UP [pointer_deref] */
/* 954 */ NdrFcShort( 0xfffffdbc ), /* Offset= -580 (312) */
/* 958 */ 0x12, 0x10, /* FC_UP [pointer_deref] */
/* 962 */ NdrFcShort( 0xfffffddca ), /* Offset= -566 (330) */
/* 966 */ 0x12, 0x10, /* FC_UP [pointer_deref] */
/* 970 */ NdrFcShort( 0xfffffdd8 ), /* Offset= -552 (348) */
/* 974 */ 0x12, 0x10, /* FC_UP [pointer_deref] */
/* 978 */ 0x12, 0x0, /* FC_UP */
/* 982 */ NdrFcShort( 0x16 ), /* Offset= 22 (930) */
/* 986 */ 0x15, /* FC_STRUCT */
/* 990 */ 0x7, /* 7 */
/* 994 */ NdrFcShort( 0x10 ), /* 16 */
/* 998 */ /* FC_SHORT */
/* 1002 */ 0x1, /* FC_BYTE */
/* 1006 */ /* FC_ALIGNM4 */
/* 1010 */ 0x38, /* FC_ALIGNM4 */
/* 1014 */ /* FC_LONG */
/* 1018 */ 0x39, /* FC_ALIGNM8 */
/* 1022 */ /* FC_HYPER */
/* 1026 */ 0x5b, /* FC_END */
/* 1030 */ 0x12, 0x0, /* FC_UP */
```

```
/* 924 */ NdrFcShort( 0xffffffff2 ), /* Offset= -14 (910) */
/* 926 */ 0x12, 0x8, /* FC_UP [simple_pointer] */
/* 928 */ /* FC_CHAR */
/* 930 */ 0x5c, /* FC_PAD */
/* 932 */ 0x1a, /* FC_BOGUS_STRUCT */
/* 934 */ 0x7, /* 7 */
/* 936 */ NdrFcShort( 0x20 ), /* 32 */
/* 938 */ NdrFcShort( 0x0 ), /* 0 */
/* 940 */ NdrFcShort( 0x0 ), /* Offset= 0 (936) */
/* 942 */ /* FC_LONG */
/* 944 */ 0x8, /* FC_LONG */
/* 946 */ /* FC_SHORT */
/* 948 */ 0x6, /* FC_SHORT */
/* 950 */ /* FC_SHORT */
/* 952 */ 0x6, /* FC_SHORT */
/* 954 */ /* FC_EMBEDDED_COMPLEX */
/* 956 */ 0x0, /* 0 */
/* 958 */ NdrFcShort( 0xfffffc54 ), /* Offset= -940 (6) */
/* 960 */ /* FC_PAD */
/* 962 */ 0x5b, /* FC_END */
/* 964 */ /* FC_USER_MARSHAL */
/* 966 */ 0x83, /* 131 */
/* 968 */ NdrFcShort( 0x0 ), /* 0 */
/* 970 */ NdrFcShort( 0x18 ), /* 24 */
/* 972 */ NdrFcShort( 0x0 ), /* 0 */
/* 974 */ NdrFcShort( 0xfffffc44 ), /* Offset= -956 (2) */
/* 976 */ 0x11, 0x4, /* FC_FP [allocated_on_stack] */
/* 978 */ /* Offset= 6 (968) */
/* 980 */ 0x13, 0x0, /* FC_OP */
/* 982 */ NdrFcShort( 0xfffffddc ), /* Offset= -36 (930) */
/* 984 */ /* FC_USER_MARSHAL */
/* 986 */ 0x83, /* 131 */
/* 988 */ NdrFcShort( 0x0 ), /* 0 */
/* 990 */ NdrFcShort( 0x18 ), /* 24 */
/* 992 */ NdrFcShort( 0x0 ), /* 0 */
/* 994 */ NdrFcShort( 0xfffffff4 ), /* Offset= -12 (964) */
/* 996 */ 0x0
};

const CInterfaceProxyVtbl * _tpcc_com_ps_ProxyVtblList[] =
{
    ( CInterfaceProxyVtbl *) &_ITPCCProxyVtbl,
    0
};

const CInterfaceStubVtbl * _tpcc_com_ps_StubVtblList[] =
{
    ( CInterfaceStubVtbl *) &_ITPCCStubVtbl,
    0
};

PCInterfaceName const _tpcc_com_ps_InterfaceNamesList[] =
{
    "ITPCC",
    0
};
```

Appendix A - Application Source Code

```
#define _tpcc_com_ps_CHECK_IID(n) IID_GENERIC_CHECK_IID( _tpcc_com_ps, pIID, n)

int __stdcall _tpcc_com_ps_IID_Lookup( const IID * pIID, int * pIndex )
{
    if(!_tpcc_com_ps_CHECK_IID(0))
    {
        *pIndex = 0;
        return 1;
    }

    return 0;
}

const ExtendedProxyFileInfo tpcc_com_ps_ProxyFileInfo =
{
    (PCInterfaceProxyVtblList *) & _tpcc_com_ps_ProxyVtblList,
    (PCInterfaceStubVtblList *) & _tpcc_com_ps_StubVtblList,
    (const PCInterfaceName * ) & _tpcc_com_ps_InterfaceNamesList,
    0, // no delegation
    & _tpcc_com_ps_IID_Lookup,
    1,
    2,
    0, /* table of [async_uuid] interfaces */
    0, /* Filler1 */
    0, /* Filler2 */
    0 /* Filler3 */
};

#endif /* defined(_M_IA64) || defined(_M_AXP64)*/
```

common/txnlog/include/ratetime.h

```
/* FILE: ratetime.h : header file
 * Copyright 1997 Microsoft Corp., All rights reserved.
 *
 * Authors: Charles Levine, Philip Durr
 *          Microsoft Corp.
 */

#define MAX_JULIAN_TIME          0x7FFFFFFFFFFFFFFF
#define JULIAN_TIME__int64
#define TC_TIME                 DWORD
extern "C"
{
    BOOL          InitJulianTime(LPSYSTEMTIME lpInitTime);
    JULIAN_TIME   GetJulianTime(void);
    DWORD         MyTickCount(void);
    void          GetJulianAndTC(JULIAN_TIME *pJulian, DWORD *pTC);
    JULIAN_TIME   ConvertTo64BitTime(int iYear, int iMonth, int iDay, int iHour, int
    iMinute, int iSecond);
    JULIAN_TIME   Get64BitTime(LPSYSTEMTIME lpInitTime);
    int           JulianDay( int yr, int mm, int dd );
}
```

```
void          JulianToTime(JULIAN_TIME julianTS, int* yr, int* mm, int* dd, int
*hh, int *mi, int *ss );
void          JulianToCalendar( int day, int* yr, int* mm, int* dd );
}
```

common/txnlog/include/spinlock.h

```
/*          FILE: SPINLOCK.H
 *
 * Copyright 1997 Microsoft Corp., All rights reserved.
 *
 * Authors: Mike Parkes, Charles Levine, Philip Durr
 *          Microsoft Corp.
 */

#ifdef _INC_Spinlock

    const LONG LockClosed      = 1;
    const LONG LockOpen       = 0;

    /*****
     *
     * Spinlock and Semaphore locking.
     *
     * This class provides a very conservative locking scheme.
     * The assumption behind the code is that locks will be
     * held for a very short time. When a lock is taken a memory
     * location is exchanged. All other threads that want this
     * lock wait by spinning and sometimes sleeping on a semaphore
     * until it becomes free again. The only other choice is not
     * to wait at all and move on to do something else. This
     * module should normally be used in conjunction with cache
     * aligned memory in minimize cache line misses.
     *
     *****/

    class Spinlock
    {
        // Private data.
        HANDLE          Semaphore;
        volatile LONG  m_Spinlock;
        volatile LONG  Waiting;

#ifdef _DEBUG
        // Counters for debugging builds.
        volatile LONG  TotalLocks;
        volatile LONG  TotalSleeps;
        volatile LONG  TotalSpins;
        volatile LONG  TotalWaits;
#endif

    public:
        // Public functions.
        Spinlock( void );
    };
#endif
```

Appendix A - Application Source Code

```
        inline BOOL ClaimLock( BOOL Wait = TRUE );
        inline void ReleaseLock( void );
        ~Spinlock( void );
        // Disabled operations.
        Spinlock( const Spinlock & Copy );
        void operator=( const Spinlock & Copy );

    private:
        // Private functions.
        inline BOOL ClaimSpinlock( volatile LONG *sl );
        void WaitForLock( void );
        void WakeAllSleepers( void );
};

/*****
 *
 * A guaranteed atomic exchange.
 *
 * An attempt is made to claim the Spinlock. This action is
 * guaranteed to be atomic.
 *****/

inline BOOL Spinlock::ClaimSpinlock( volatile LONG *Spinlock )
{
    #ifdef _DEBUG
        InterlockedIncrement( (LPLONG) & TotalLocks );
    #endif
    return ( ((*Spinlock) == LockOpen) && (InterlockedExchange(
(LPLONG)Spinlock, LockClosed) == LockOpen) );
}

/*****
 *
 * Claim the Spinlock.
 *
 * Claim the lock if available else wait or exit.
 *****/

inline BOOL Spinlock::ClaimLock( BOOL Wait )
{
    if ( ! ClaimSpinlock( (volatile LONG*) & m_Spinlock ) )
    {
        if ( Wait )
            WaitForLock();
        return Wait;
    }
    return TRUE;
}

/*****
 *
 * Release the Spinlock.
 *
 * Release the lock and if needed wakeup any sleepers.
 *****/

inline void Spinlock::ReleaseLock( void )
{
    m_Spinlock = LockOpen;
}
```

```
        if ( Waiting > 0 )
            WakeAllSleepers();
    }

    #define _INC_Spinlock

#endif
```

common/txnlog/include/txnlog.h

```
/* FILE: TXNLOG.H
 * Microsoft TPC-C Kit Ver. 4.10.000
 *
 * NOTE: this file is RTE specific and should not be
 * included
 * in Full Disclosure Reports.
 *
 * Copyright Microsoft, 1999
 *
 * PURPOSE: Structure definitions for logging delivery txn completion stats.
 * Contact: Charles Levine (clevine@microsoft.com)
 */

typedef struct _TXN_NEWORDER
{
    BYTE OL_Count; //range 0 to 31
    BYTE OL_Remote_Count; //range 0 to 31
    WORD c_id;
    int o_id;
} TXN_NEWORDER;

typedef struct _TXN_PAYMENT
{
    BYTE CustByName;
    BYTE IsRemote;
} TXN_PAYMENT;

typedef struct _TXN_ORDERSTATUS
{
    BYTE CustByName;
} TXN_ORDERSTATUS;

typedef union _TXN_DETAILS
{
    TXN_NEWORDER NewOrder;
    TXN_PAYMENT Payment;
    TXN_ORDERSTATUS OrderStatus;
} TXN_DETAILS;

// Common header for all records in txn log. The TxnType field is
// a switch which identifies the particular variant.
#define TXN_REC_TYPE_CONTROL 1 //
```

Appendix A - Application Source Code

```

#define TXN_REC_TYPE_TPCC                2        // replaces
TRANSACTION_TYPE_TPCC
#define TXN_REC_TYPE_TPCC_DELIV_DEF     3

typedef struct _TXN_RECORD_HEADER
{
    JULIAN_TIME    TxnStartT0;           // start of txn
    BYTE          TxnType;               // one of TXN_REC_TYPE_*
    BYTE          TxnSubType;           // depends on
TxnType
} TXN_RECORD_HEADER, *PTXN_RECORD_HEADER;

typedef struct _TXN_RECORD_CONTROL
{
    // common header; must exactly match TXN_RECORD_HEADER
    JULIAN_TIME    TxnStartT0;           // start of txn
    BYTE          TxnType;               // = TXN_REC_TYPE_CONTROL
    BYTE          TxnSubType;           // depends on
TxnType

    // end of common header

    DWORD         Len;                  // number of bytes
after this field
} TXN_RECORD_CONTROL, *PTXN_RECORD_CONTROL;

// TPC-C Txn Record Layout:
//
// 'TxnStartT0' is a Julian timestamp corresponding to the moment the
// txn is sent to the SUT, i.e., beginning of response time. Deltas
// are in milliseconds. Note that if RTDelay > 0, then the txn was
// delayed by this amount. The delay occurs at the beginning of the
// response time. So if RTDelay > 0, then the txn was actually sent
// at TxnStartT0 + RTDelay.
//
// Graphically:
//
// time -->
//
// |--- Menu ---|--- Keying ---|--- Response ---|--- Think ---|
// <- DeltaT1 -> <- DeltaT2 -> <- DeltaT4 -> <- DeltaT3 ->
//
//                               ^
//                               TxnStartT0
//
// RTDelay is the amount of response time delay included in DeltaT4.
// RTDelay is recorded per txn because this value can be changed on
// the fly, and so may vary from txn to txn.
//
// TxnStatus is the txn completion code. It is used to indicate errors.
// For example, in the New Order txn, 1% of txns abort. TxnStatus will
// reflect this.

typedef struct _TXN_RECORD_TPCC
{
    // common header; must exactly match TXN_RECORD_HEADER
    JULIAN_TIME    TxnStartT0;           // start of txn
    BYTE          TxnType;               // = TXN_REC_TYPE_TPCC
    BYTE          TxnSubType;           // depends on
TxnType

    // end of common header

    int           DeltaT1;              // menu time (ms)

```

```

    int           DeltaT2;              // keying time (ms)
    int           DeltaT3;              // think time (ms)
    int           DeltaT4;              // response time (ms)
    int           RTDelay;              // response time delay (ms)
    int           TxnError;             // error code providing more
detail for TxnStatus
    WORD          w_id;                 // warehouse ID
    BYTE          d_id;                 // assigned district ID for
this thread
    BYTE          d_id_ThisTxn;         // district ID chosen for this
particular
    BYTE          TxnStatus;            // completion status for txn
to indicate errors
    BYTE          reserved;             // for word alignment
    TXN_DETAILS    TxnDetails;          //
} TXN_RECORD_TPCC, *PTXN_RECORD_TPCC;

// TPC-C Deferred Delivery Txn Record Layout:
//
// Incorporating delivery transaction information into the above
// structure would increase the size of TXN_DETAILS from 8 to 42 bytes.
// Hence, we store delivery transaction details in a separate structure.
//
typedef struct _TXN_RECORD_TPCC_DELIV_DEF
{
    // common header; must exactly match TXN_RECORD_HEADER
    JULIAN_TIME    TxnStartT0;           // start of txn
    BYTE          TxnType;               // =
TXN_REC_TYPE_TPCC_DELIV_DEF
    BYTE          TxnSubType;           // = 0
// end of common header

    int           DeltaT4;              // response time (ms)
    int           DeltaTxnExec;         // execution time (ms)
    WORD          w_id;                 // warehouse ID
    BYTE          TxnStatus;            // completion status for txn
to indicate errors
    BYTE          reserved;             // for word alignment
    short         o_carrier_id;         // carrier id
    long          o_id[10];             // returned delivery transaction ids
} TXN_RECORD_TPCC_DELIV_DEF, *PTXN_RECORD_TPCC_DELIV_DEF;

#define TXN_LOG_VERSION                  1
#define TXN_DATA_START                  4096 // offset in log file where
log records start
#define TXN_LOG_EYE_CATCHER"BC"         // signature bytes at the start of log
file

////////////////////////////////////
// The transaction log has a header as the first 4K block.
//
typedef struct _TXN_LOG_HEADER
{
    char          EyeCatcher[2];        // signature bytes;
should always be "BC"
    int           LogVersion;
// set to TXN_LOG_VERSION
    JULIAN_TIME    BeginTxnTS;         //
timestamp of first (lowest) txn start

```

Appendix A - Application Source Code

```
        JULIAN_TIME          EndTxnTS;          // timestamp of
last (highest) txn completion time
        int
        // number of records in log file
        BOOL                bLogSorted;
        int                 iFileSize;
        // file size in bytes

        // the record map provides a fast way to get close to a particular
timestamp in a sorted log file.
//
//      struct
//      {
//          JULIAN_TIME      TS;
//          // timestamp of record
//          int              iPos;
//          // byte position in file
//      }
// #define RecMapSize
//          RecMap[RecMapSize];
//          200
//      } TXN_LOG_HEADER, *PTXN_LOG_HEADER;

#define READ_BUFFER_SIZE      64*1024
#define WRITE_BUFFER_SIZE    8*1024

#define NUM_READ_BUFFERS      1
#define NUM_WRITE_BUFFERS    2
#define MAX_NUM_BUFFERS      2

// flags passed in to the constructor
#define TXN_LOG_WRITE         0x01
#define TXN_LOG_READ         0x02
#define TXN_LOG_SORTED       0x04

#define TXN_LOG_OS_ERROR     1
#define TXN_LOG_NOT_SORTED   2

#define SKIP_CTRL_RECS       1

class CTxnLog
{
private:
    DWORD          iBufferSize;          //buffer
allocated size
    DWORD          iBytesFreeInBuffer;    //total bytes
available for use in buffer
    int            iNumBuffers;
//buffers in use
    int            iActiveBuffer;
//indicates which buffer is active: 0 or 1
    int            iIoBuffer;
//buffer for any pending IO operation
    int            iFilePointer;
//position in file.
    int            iNextRec;
//when reading, ordinal value of next record

// A "save point" is remembered each time GetNextRecord is called
with a start time specified.
// The next time it is called, if start time is after the save point,
we start scanning from the
```

```
        // save point. This is particularly useful in FindBestInterval,
where the log is scanned repeatedly.
        JULIAN_TIME          SavePtTime;
        int                  iSavePtFilePointer;
        int                  iSavePtNextRec;

        JULIAN_TIME          lastTS;
//when writing sorted output, used to verify records are sorted
        BOOL                bWrite;
//writing log file

        BOOL                bLogSorted;
// is log file sorted? applies to both input and output
        JULIAN_TIME          BeginTxnTS;
// timestamp of first (lowest) txn start
        JULIAN_TIME          EndTxnTS;
timestamp of last (highest) txn completion time
        int                  iRecCount;
// number of records in log file

        BYTE                *pCurrent;
//ptr to current buffer
        BYTE                *pBuffer[MAX_NUM_BUFFERS];

        PTXN_RECORD_HEADER *TxnArray;
record pointer array for sort
//transaction

        DWORD              dwError;
        HANDLE             hTxnFile;
to log file
//handle

        HANDLE             hMapFile;
file used when sorting the log
//map

        HANDLE             hIoComplete;
to signify that there are no pending IOs
//event

        HANDLE             hLogFileIo;
//event to signal the IO thread to write the inactive buffer

        Spinlock Spin;
lock to protect the txn log file buffers
//spin

        int Write(BYTE *ptr, DWORD Size);
        static void LogFileIO(CTxnLog *);

public:
    CTxnLog(LPCTSTR szFileName, DWORD dwOpts);
    ~CTxnLog(void);

    int WriteToLog(PTXN_RECORD_TPCC pTxnRcrd);
    int WriteToLog(PTXN_RECORD_TPCC_DELIV_DEF pTxnRcrd);
    int WriteToLog(PTXN_RECORD_CONTROL pCtrlRec);
    int WriteToLog(PTXN_RECORD_HEADER pCtrlRec);

    int WriteCtrlRecToLog(BYTE SubType, LPCTSTR lpStr, DWORD dwLen);

    void CloseTransactionLogFile(void);

    PTXN_RECORD_HEADER GetNextRecord(BOOL bSkipCtrlRecs = FALSE);
    PTXN_RECORD_HEADER GetNextRecord(JULIAN_TIME SeekTimeT0, BOOL
bSkipCtrlRecs = FALSE);

    int Sort(void);
    PTXN_RECORD_HEADER GetSortedRecord(int index);
```

Appendix A - Application Source Code

```
        inline BOOL IsSorted(void) { return bLogSorted; };
        inline JULIAN_TIME BeginTS(void) { return BeginTxnTS; };
        inline JULIAN_TIME EndTS(void) { return EndTxnTS; };
        inline int RecordCount(void) { return iRecCount; };
};

class CTXNLOG_ERR : public CBaseErr
{
    public:
        enum CTPCC_DBLIB_ERRS
        {
            ERR_BAD_FILE_FORMAT = 1,    // "File format is invalid."
            ERR_UNKNOWN_LOG_VERSION,    // "Log file version is
unknown."
            ERR_BROKEN_LOG_FILE,        // "Log file is
broken."
            ERR_LOG_NOT_SORTED,        // "Log file is not
sorted"
            ERR_INVALID_TIME_SEQ,      // "Internal Error:
Record Time Sequence invalid."
        };

        CTXNLOG_ERR( int iErr ) { m_errno = iErr; };

        int m_errno;

        int ErrorType() {return ERR_TYPE_TXNLOG;};
        int ErrorNum() {return m_errno;};

        // TODO: need to complete...
        char *ErrorText() {return ""};
};
```

Appendix B - Database Design

Appendix B - Database Design

Build Scripts

setup.cmd

```
ECHO OFF

@ECHO *****
@ECHO *
@ECHO * Microsoft TPC-C Benchmark Kit Ver. 4.01 *
@ECHO *
@ECHO *****

if '%1'==' ' goto usage
if '%2'==' ' goto usage
if '%3'==' ' goto usage
if '%4'==' ' goto usage
if not '%5'==' ' if not '%5' == 'scaled' goto usage

::Cleanup any old .err files
@if exist logs\*.err del logs\*.err
>nul

if '%3'=='full' goto start
if '%3'=='bulddb' goto bulddb
if '%3'=='objects' goto objects
if '%3'=='bulkload' goto bulkload
if '%3'=='objectsfull' goto objects
if '%3'=='bulkloadfull' goto bulkload
if '%3'=='backup' goto backup
goto usage

:start
:: Cleanup the logs directory...
@if exist logs\version.log del logs\version.log >nul
@if exist logs\db.log del logs\db.log >nul
@if exist logs\objects.log del logs\objects.log >nul
@if exist logs\objects.log del logs\objects.log >nul
@if exist logs\bulkload.log del logs\bulkload.log >nul
@if exist logs\backup.log del logs\backup.log >nul

isql -Usa -P -S%1 -Q"select @@version"
logs\version.log >
isql -Usa -P -S%1 -Q"select getdate()"
logs\version.log >>

:bulddb
@if exist logs\db.log del logs\db.log >nul
@ECHO Building database files and database...
isql -Usa -P -S%1 -e < scripts\%2.war\%4\createdb.sql
logs\db.log >
@ECHO Database build complete.
if '%3'=='full' goto objects
```

```
goto end

:objects
@if exist logs\objects.log del logs\objects.log >nul
@ECHO Creating database objects...
isql -Usa -P -S%1 -e < scripts\ddl\%4\tables.sql > logs\objects.log
isql -Usa -P -S%1 -e < scripts\dml\%4\neword.sql >> logs\objects.log
isql -Usa -P -S%1 -e < scripts\dml\%4\payment.sql >> logs\objects.log
isql -Usa -P -S%1 -e < scripts\dml\%4\ordstat.sql >> logs\objects.log
isql -Usa -P -S%1 -e < scripts\dml\%4\delivery.sql >>
logs\objects.log
isql -Usa -P -S%1 -e < scripts\dml\%4\stocklev.sql >>
logs\objects.log
@ECHO Database object creation complete.
if '%3'=='full' goto bulkload
if '%3'=='objectsfull' goto bulkload
goto end

:bulkload
@if exist logs\bulkload.log del logs\bulkload.log >nul
@ECHO Beginning data load and index creation...
isql -Usa -P -S%1 -e < scripts\utility\%4\dbopt1.sql >>
logs\objects.log
if '%4'=='mssql70' goto odbcc
if '%4'=='mssql65' goto dblink
goto usage
:dblib
if '%5'==' ' loader\%4\bin\tpccldr -S%1 -W%2 -flogs\bulkload.log -dscripsts\ddl\%4 -c0
if '%5'=='normal' loader\%4\bin\tpccldr -S%1 -W%2 -flogs\bulkload.log -dscripsts\ddl\%4 -c0
if '%5'=='scaled' loader\%4\bin\tpccldr -S%1 -W%2 -flogs\bulkload.log -dscripsts\ddl\%4 -c1
goto bulkloaddone
:odbcc
if '%5'==' ' loader\%4\bin\tpccldr -S%1 -W%2 -flogs\bulkload.log -dscripsts\ddl\%4 -c0
if '%5'=='normal' loader\%4\bin\tpccldr -S%1 -W%2 -flogs\bulkload.log -dscripsts\ddl\%4 -c0
if '%5'=='scaled' loader\%4\bin\tpccldr -S%1 -W%2 -flogs\bulkload.log -dscripsts\ddl\%4 -c1
goto bulkloaddone
:bulkloaddone
isql -Usa -P -S%1 -e < scripts\utility\%4\dbopt2.sql >>
logs\bulkload.log
@ECHO Data load and index creation complete.
if '%3'=='full' goto backup
if '%3'=='objectsfull' goto backup
if '%3'=='bulkloadfull' goto backup
goto end

:backup
@if exist logs\backup.log del logs\backup.log >nul
@ECHO Backing up database...
isql -Usa -P -S%1 -e < scripts\%2.war\%4\backup.sql >
logs\backup.log
@ECHO Database backup complete.
if '%3'=='full' goto verifyload
if '%3'=='objectsfull' goto verifyload
if '%3'=='bulkloadfull' goto verifyload
goto complete

:verifyload
@if exist logs\verifyload.log del logs\verifyload.log >nul
@ECHO Verifying TPC-C database load...
```

Appendix B - Database Design

```
isql -Usa -P -S%1 < scripts\utility\%4\verifytpccload.sql >
logs\verifyload.log
@ECHO Check logs\verifyload.log to verify database load.

:complete
@ECHO *****
@ECHO *
@ECHO * Full TPC-C build complete. Check logs directory for setup errors. *
@ECHO *
@ECHO *****
goto end

:usage
@ECHO *****
@ECHO *
@ECHO * The TPC-C setup command file requires the following parameters: *
@ECHO *
@ECHO * setup SERVER NUMWAR BLDOPT VERSION DBTYPE *
@ECHO *
@ECHO * SERVER = machine name of server (use "" for local server) *
@ECHO * NUMWAR = number of warehouses *
@ECHO * BLDOPT = full, bulddb, objects, objectsfull, bulkload, *
@ECHO *          bulkloadfull, or backup *
@ECHO * VERSION = mssql65 or mssql70 *
@ECHO * DBTYPE = normal or scaled *
@ECHO *
@ECHO * Note #1: the BLDOPT and VERSION parameters are case sensitive. *
@ECHO *
@ECHO * Note #2: the DBTYPE is optional. If no DBTYPE is specified, SETUP *
@ECHO *          will default to NORMAL. *
@ECHO *
@ECHO * Example: *
@ECHO *
@ECHO * The following command would be used to build a complete 200 *
@ECHO * warehouse database on SQL Server 7.0 running on server \\myserver. *
@ECHO *
@ECHO *          SETUP myserver 200 full mssql70 *
@ECHO *
@ECHO * Note, this command file does a backup of the database by default *
@ECHO * after the database build process is complete. If you do not wish *
@ECHO * to make a backup (strongly discouraged), you must edit this file *
@ECHO * and comment that section out. Also, if you need to run the dbcheck *
@ECHO * and the dbtables scripts on the fresh database load for an audit, *
@ECHO * you must either run them manually or edit this file to include them. *
@ECHO *
@ECHO *****

:end

echo on
```

createdb.sql

```
-- File:      CREATEDB.SQL
--           Microsoft TPC-C Benchmark Kit Ver. 4.21
--           Copyright Microsoft, 1999, 2000
-- Purpose:   Creates tpcc database and backup files

use master
go
```

```
-- Create temporary table for timing

if exists ( select name from sysobjects where name = 'tpcc_timer' )
drop table tpcc_timer
go

create table tpcc_timer
(
    start_date          char(30),
    end_date            char(30)
)

insert into tpcc_timer values (0,0)
go

-- Store starting time

update tpcc_timer
set start_date = (select convert(char(30), getdate(),9))
go

-- create main database files

CREATE DATABASE tpcc
ON PRIMARY
(
    NAME = MSSQL70_tpcc_root,
    FILENAME = "C:\MSSQL70_tpcc_root.mdf",
    SIZE = 8MB,
    FILEGROWTH = 0),

FILEGROUP MSSQL70_misc_fg
(
    NAME = MSSQL70_misc1,
    FILENAME = "F:",
    SIZE = 37584MB,
    FILEGROWTH = 0),

FILEGROUP MSSQL70_cs_fg
(
    NAME = MSSQL70_cs1,
    FILENAME = "E:",
    SIZE = 68064MB,
    FILEGROWTH = 0)

LOG ON
(
    NAME = MSSQL70_tpccv3_log,
    FILENAME = "S:",
    SIZE = 34304MB,
    FILEGROWTH = 0)

go

-- Store ending time
update tpcc_timer
set end_date = (select convert(char(30), getdate(),9))
go

select "Elapsed time (in seconds): ", datediff(second,(select start_date from
tpcc_timer),(select end_date from tpcc_timer))

-- remove temporary table

if exists ( select name from sysobjects where name = 'tpcc_timer' )
drop table tpcc_timer
go
```

Appendix B - Database Design

tables.sql

```
-- File: TABLES.SQL
-- Microsoft TPC-C Benchmark Kit Ver. 4.00
-- Copyright Microsoft, 1996
-- Purpose: Creates TPC-C tables

use tpcc
go

if exists ( select name from sysobjects where name = 'warehouse' )
    drop table warehouse
go
create table warehouse
(
    w_id                smallint,
    w_name              char(10),
    w_street_1          char(20),
    w_street_2          char(20),
    w_city              char(20),
    w_state             char(2),
    w_zip              char(9),
    w_tax              numeric(4,4),
    w_ytd              numeric(12,2)
) on MSSQL70_misc_fg
go

if exists ( select name from sysobjects where name = 'district' )
    drop table district
go
create table district
(
    d_id                tinyint,
    d_w_id              smallint,
    d_name              char(10),
    d_street_1          char(20),
    d_street_2          char(20),
    d_city              char(20),
    d_state             char(2),
    d_zip              char(9),
    d_tax              numeric(4,4),
    d_ytd              numeric(12,2),
    d_next_o_id        int
) on MSSQL70_misc_fg
go

if exists ( select name from sysobjects where name = 'customer' )
    drop table customer
go
create table customer
(
    c_id                int,
    c_d_id              tinyint,
    c_w_id              smallint,
    c_first             char(16),
    c_middle            char(2),
    c_last              char(16),
    c_street_1          char(20),
    c_street_2          char(20),
    c_city              char(20),
    c_state             char(2),
```

```

    c_zip              char(9),
    c_phone            char(16),
    c_since            datetime,
    c_credit           char(2),
    c_credit_lim       numeric(12,2),
    c_discount         numeric(4,4),
    c_balance          numeric(12,2),
    c_ytd_payment      numeric(12,2),
    c_payment_cnt      smallint,
    c_delivery_cnt     smallint,
    c_data             char(500)
) on MSSQL70_cs_fg
go

if exists ( select name from sysobjects where name = 'history' )
    drop table history
go
create table history
(
    h_c_id              int,
    h_c_d_id           tinyint,
    h_c_w_id           smallint,
    h_d_id             tinyint,
    h_w_id             smallint,
    h_date             datetime,
    h_amount           numeric(6,2),
    h_data             char(24)
) on MSSQL70_misc_fg
go

if exists ( select name from sysobjects where name = 'new_order' )
    drop table new_order
go
create table new_order
(
    no_o_id            int,
    no_d_id            tinyint,
    no_w_id            smallint
) on MSSQL70_misc_fg
go

if exists ( select name from sysobjects where name = 'orders' )
    drop table orders
go
create table orders
(
    o_id               int,
    o_d_id             tinyint,
    o_w_id             smallint,
    o_c_id             int,
    o_entry_d          datetime,
    o_carrier_id       tinyint,
    o_ol_cnt           tinyint,
    o_all_local        tinyint
) on MSSQL70_misc_fg
go

if exists ( select name from sysobjects where name = 'order_line' )
    drop table order_line
go
create table order_line
(
    ol_o_id            int,
```

Appendix B - Database Design

```
        ol_d_id                tinyint,
        ol_w_id                smallint,
        ol_number              tinyint,
        ol_i_id                int,
        ol_supply_w_id         smallint,
        ol_delivery_d          datetime,
        ol_quantity            smallint,
        ol_amount              numeric(6,2),
        ol_dist_info           char(24)
) on MSSQL70_misc_fg
go

if exists ( select name from sysobjects where name = 'item' )
    drop table item
go
create table item
(
    i_id                int,
    i_im_id             int,
    i_name              char(24),
    i_price             numeric(5,2),
    i_data              char(50)
) on MSSQL70_misc_fg
go

if exists ( select name from sysobjects where name = 'stock' )
    drop table stock
go
create table stock
(
    s_i_id                int,
    s_w_id                smallint,
    s_quantity            smallint,
    s_dist_01            char(24),
    s_dist_02            char(24),
    s_dist_03            char(24),
    s_dist_04            char(24),
    s_dist_05            char(24),
    s_dist_06            char(24),
    s_dist_07            char(24),
    s_dist_08            char(24),
    s_dist_09            char(24),
    s_dist_10            char(24),
    s_ytd                int,
    s_order_cnt          smallint,
    s_remote_cnt         smallint,
    s_data              char(50)
) on MSSQL70_cs_fg
go
```

idxcuscl.sql

```
-- File:      IDXCUSCL.SQL
--           Microsoft TPC-C Benchmark Kit Ver. 4.00
--           Copyright Microsoft, 1996
-- Purpose:   Creates clustered index on customer table
```

```
use tpcc
go

declare @startdate datetime
declare @enddate datetime
select @startdate = getdate()
select "Start date:", convert(varchar(30),@startdate,9)

if exists ( select name from sysindexes where name = 'customer_cl' )
    drop index customer.customer_cl

create unique clustered index customer_cl on customer(c_w_id, c_d_id, c_id)
on MSSQL70_cs_fg

select @enddate = getdate()
select "End date: ", convert(varchar(30),@enddate,9)
select "Elapsed time (in seconds): ", datediff(second, @startdate, @enddate)

go
```

idxcusnc.sql

```
-- File:      IDXCUSNC.SQL
--           Microsoft TPC-C Benchmark Kit Ver. 4.00
--           Copyright Microsoft, 1996
-- Purpose:   Creates non-clustered index on customer table
```

```
use tpcc
go

declare @startdate datetime
declare @enddate datetime
select @startdate = getdate()
select "Start date:", convert(varchar(30),@startdate,9)

if exists ( select name from sysindexes where name = 'customer_nc1' )
    drop index customer.customer_nc1

create unique nonclustered index customer_nc1 on customer(c_w_id, c_d_id, c_last,
c_first, c_id)
on MSSQL70_cs_fg

select @enddate = getdate()
select "End date: ", convert(varchar(30),@enddate,9)
select "Elapsed time (in seconds): ", datediff(second, @startdate, @enddate)

go
```

idxdiscl.sql

Appendix B - Database Design

```
-- File:      IDXDISCL.SQL
--           Microsoft TPC-C Benchmark Kit Ver. 4.00
--           Copyright Microsoft, 1996
-- Purpose:   Creates clustered index on district table

use tpcc
go

declare @startdate datetime
declare @enddate datetime
select @startdate = getdate()
select "Start date:", convert(varchar(30),@startdate,9)

if exists ( select name from sysindexes where name = 'district_cl' )
    drop index district.district_cl

create unique clustered index district_cl on district(d_w_id, d_id)
    with fillfactor=100 on MSSQL70_misc_fg

select @enddate = getdate()
select "End date: ", convert(varchar(30),@enddate,9)
select "Elapsed time (in seconds): ", datediff(second, @startdate, @enddate)

go
```

idxitmcl.sql

```
-- File:      IDXITMCL.SQL
--           Microsoft TPC-C Benchmark Kit Ver. 4.00
--           Copyright Microsoft, 1996
-- Purpose:   Creates clustered index on item table

use tpcc
go

declare @startdate datetime
declare @enddate datetime
select @startdate = getdate()
select "Start date:", convert(varchar(30),@startdate,9)

if exists ( select name from sysindexes where name = 'item_cl' )
    drop index item.item_cl

create unique clustered index item_cl on item(i_id)
    on MSSQL70_misc_fg

select @enddate = getdate()
select "End date: ", convert(varchar(30),@enddate,9)
select "Elapsed time (in seconds): ", datediff(second, @startdate, @enddate)

go
```

idxnodcl.sql

```
-- File:      IDXNODCL.SQL
--           Microsoft TPC-C Benchmark Kit Ver. 4.00
--           Copyright Microsoft, 1996
-- Purpose:   Creates clustered index on new_order table

use tpcc
go

declare @startdate datetime
declare @enddate datetime
select @startdate = getdate()
select "Start date:", convert(varchar(30),@startdate,9)

if exists ( select name from sysindexes where name = 'new_order_cl' )
    drop index new_order.new_order_cl

create unique clustered index new_order_cl on new_order(no_w_id, no_d_id, no_o_id)
    on MSSQL70_misc_fg

select @enddate = getdate()
select "End date: ", convert(varchar(30),@enddate,9)
select "Elapsed time (in seconds): ", datediff(second, @startdate, @enddate)

go
```

idxodcl.sql

```
-- File:      IDXNODCL.SQL
--           Microsoft TPC-C Benchmark Kit Ver. 4.00
--           Copyright Microsoft, 1996
-- Purpose:   Creates clustered index on new_order table

use tpcc
go

declare @startdate datetime
declare @enddate datetime
select @startdate = getdate()
select "Start date:", convert(varchar(30),@startdate,9)

if exists ( select name from sysindexes where name = 'new_order_cl' )
    drop index new_order.new_order_cl

create unique clustered index new_order_cl on new_order(no_w_id, no_d_id, no_o_id)
    on MSSQL70_misc_fg

select @enddate = getdate()
select "End date: ", convert(varchar(30),@enddate,9)
select "Elapsed time (in seconds): ", datediff(second, @startdate, @enddate)

go
```

Appendix B - Database Design

idxordcl.sql

```
-- File:      IDXORDCL.SQL
--           Microsoft TPC-C Benchmark Kit Ver. 4.00
--           Copyright Microsoft, 1996
-- Purpose:   Creates clustered index on orders table

use tpcc
go

declare @startdate datetime
declare @enddate datetime
select @startdate = getdate()
select "Start date:", convert(varchar(30),@startdate,9)

if exists ( select name from sysindexes where name = 'orders_c1' )
    drop index orders.orders_c1

create unique clustered index orders_c1 on orders(o_w_id, o_d_id, o_id)
    on MSSQL70_misc_fg

select @enddate = getdate()
select "End date: ", convert(varchar(30),@enddate,9)
select "Elapsed time (in seconds): ", datediff(second, @startdate, @enddate)

go
```

idxstkcl.sql

```
-- File:      IDXSTKCL.SQL
--           Microsoft TPC-C Benchmark Kit Ver. 4.00
--           Copyright Microsoft, 1996
-- Purpose:   Creates clustered index on stock table

use tpcc
go

declare @startdate datetime
declare @enddate datetime
select @startdate = getdate()
select "Start date:", convert(varchar(30),@startdate,9)

if exists ( select name from sysindexes where name = 'stock_c1' )
    drop index stock.stock_c1

create unique clustered index stock_c1 on stock(s_i_id, s_w_id)
    on MSSQL70_cs_fg

select @enddate = getdate()
select "End date: ", convert(varchar(30),@enddate,9)
select "Elapsed time (in seconds): ", datediff(second, @startdate, @enddate)

go
```

idxwarcl.sql

```
-- File:      IDXTWARCL.SQL
--           Microsoft TPC-C Benchmark Kit Ver. 4.00
--           Copyright Microsoft, 1996
-- Purpose:   Creates clustered index on warehouse table

use tpcc
go

declare @startdate datetime
declare @enddate datetime
select @startdate = getdate()
select "Start date:", convert(varchar(30),@startdate,9)

if exists ( select name from sysindexes where name = 'warehouse_c1' )
    drop index warehouse.warehouse_c1

create unique clustered index warehouse_c1 on warehouse(w_id)
    with fillfactor=100 on MSSQL70_misc_fg

select @enddate = getdate()
select "End date: ", convert(varchar(30),@enddate,9)
select "Elapsed time (in seconds): ", datediff(second, @startdate, @enddate)

go
```

dbopt1.sql

```
-- File:      DBOPT1.SQL
--           Microsoft TPC-C Benchmark Kit Ver. 4.00
--           Copyright Microsoft, 1996
-- Purpose:   Sets database options for data load

use master
go

exec sp_dboption tpcc,'select into/bulkcopy',true
exec sp_dboption tpcc,'trunc. log on chkpt.',true
go

use tpcc
go

checkpoint
go
```

Appendix B - Database Design

dbopt2.sql

```
-- File:      DBOPT2.SQL
--           Microsoft TPC-C Benchmark Kit Ver. 4.00
--           Copyright Microsoft, 1996
-- Purpose:   Resets database options after data load
```

```
use master
go
```

```
sp_dboption tpcc,'select ',false
go
```

```
sp_dboption tpcc,'trunc. ',false
go
```

```
use tpcc
go
```

```
checkpoint
go
```

```
sp_configure allow,1
go
```

```
reconfigure with override
go
```

```
/*
/* Set option values for user-defined indexes */
/*
```

```
sp_indexoption 'customer','AllowPageLocks',FALSE
go
sp_indexoption 'district','AllowPageLocks',FALSE
go
sp_indexoption 'warehouse','AllowPageLocks',FALSE
go
sp_indexoption 'stock','AllowPageLocks',FALSE
go
sp_indexoption 'order_line','AllowPageLocks',FALSE
go
sp_indexoption 'orders','AllowPageLocks',FALSE
go
sp_indexoption 'new_order','AllowRowLocks',FALSE
go
sp_indexoption 'item','AllowRowLocks',FALSE
go
sp_indexoption 'item','AllowPageLocks',FALSE
go
```

```
Print ' '
Print '*****'
Print 'Pre-specified Locking Hierarchy:'
Print '  Lockflag = 0 ==> No pre-pecified hierarchy'
Print '  Lockflag = 1 ==> Lock at Page-level then Table-level'
Print '  Lockflag = 2 ==> Lock at Row-level then Table-level'
Print '  Lockflag = 3 ==> Lock at Table-level'
Print ' '
```

```
select name,lockflags
```

```
from sysindexes
where object_id("warehouse")=id or
      object_id("district")=id or
      object_id("customer")=id or
      object_id("stock")=id or
      object_id("orders")=id or
      object_id("order_line")=id or
      object_id("history")=id or
      object_id("new_order")=id or
      object_id("item")=id

order by lockflags asc
go

sp_configure allow,0
go

reconfigure with override
go

exec sp_dboption tpcc, 'auto update statistics', FALSE
exec sp_dboption tpcc, 'auto create statistics', FALSE
go

exec sp_tableoption "district","pintable",true
exec sp_tableoption "warehouse","pintable",true
exec sp_tableoption "new_order","pintable",true
exec sp_tableoption "item","pintable",true
go
```

dbopt3.sql

```
use tpcc
go
sp_indexoption 'orders','AllowPagelocks',TRUE
go
sp_indexoption 'orders','AllowRowlocks',FALSE
go
sp_indexoption 'order_line','AllowPagelocks',TRUE
go
sp_indexoption 'order_line','AllowRowlocks',FALSE
go
```

backup.sql

```
-- File:      BACKUP.SQL
--           Microsoft TPC-C Benchmark Kit Ver. 4.21
--           Copyright Microsoft, 1999, 2000
-- Purpose:   Creates backup of tpcc database
```

```
declare @startdate datetime
declare @enddate datetime
select @startdate = getdate()
```

Appendix B - Database Design

```
select "Start date:", convert(varchar(30),@startdate,9)
dump database tpcc to tpccback1 with init, stats = 5
select @enddate = getdate()
select "End date: ", convert(varchar(30),@enddate,9)
select "Elapsed time (in seconds): ", datediff(second, @startdate, @enddate)
go
```

restore.sql

```
-- File:      RESTORE.SQL
--           Microsoft TPC-C Benchmark Kit Ver. 4.21
--           Copyright Microsoft, 1999, 2000
-- Purpose:  Loads database backup from backup files

declare @startdate datetime
declare @enddate datetime
select @startdate = getdate()
select "Start date:", convert(varchar(30),@startdate,9)

load database tpcc from tpccback1 with stats = 5

select @enddate = getdate()
select "End date: ", convert(varchar(30),@enddate,9)
select "Elapsed time (in seconds): ", datediff(second, @startdate, @enddate)
go
```

Appendix B - Database Design

Stored Procedures

neword.sql

```
-- File:      NEWORD.SQL
--           Microsoft TPC-C Benchmark Kit Ver. 4.01
--           Copyright Microsoft, 1996
-- Purpose:   Creates new order transaction stored procedure
--
-- Modified 9/21/98 - Jamie Reding - Microsoft Corporation
--           Reordered @rowcount check so that invalid supply warehouse id,
--           as well as invalid item id, is detected and causes explicit
--           transaction rollback.
--
use tpcc
go

if exists ( select name from sysobjects where name = "tpcc_neworder" )
    drop procedure tpcc_neworder
go

create proc tpcc_neworder

    @w_id      smallint,
    @d_id      tinyint,
    @c_id      int,
    @o_ol_cnt  tinyint,
    @o_all_local tinyint,
    @i_id1 int = 0, @s_w_id1 smallint = 0,
    @i_id2 int = 0, @s_w_id2 smallint = 0,
    @i_id3 int = 0, @s_w_id3 smallint = 0,
    @i_id4 int = 0, @s_w_id4 smallint = 0,
    @i_id5 int = 0, @s_w_id5 smallint = 0,
    @i_id6 int = 0, @s_w_id6 smallint = 0,
    @i_id7 int = 0, @s_w_id7 smallint = 0,
    @i_id8 int = 0, @s_w_id8 smallint = 0,
    @i_id9 int = 0, @s_w_id9 smallint = 0,
    @i_id10 int = 0, @s_w_id10 smallint =
    @i_id11 int = 0, @s_w_id11 smallint =
    @i_id12 int = 0, @s_w_id12 smallint =
    @i_id13 int = 0, @s_w_id13 smallint =

    @ol_qty1 smallint = 0,
    @ol_qty2 smallint = 0,
    @ol_qty3 smallint = 0,
    @ol_qty4 smallint = 0,
    @ol_qty5 smallint = 0,
    @ol_qty6 smallint = 0,
    @ol_qty7 smallint = 0,
    @ol_qty8 smallint = 0,
    @ol_qty9 smallint = 0,
    0, @ol_qty10 smallint = 0,
    0, @ol_qty11 smallint = 0,
    0, @ol_qty12 smallint = 0,
    0, @ol_qty13 smallint = 0,
```

```
    @i_id14 int = 0, @s_w_id14 smallint =
    0, @ol_qty14 smallint = 0,
    @i_id15 int = 0, @s_w_id15 smallint =
    0, @ol_qty15 smallint = 0

as
declare @w_tax      numeric(4,4),
        @d_tax      numeric(4,4),
        @c_last      char(16),
        @c_credit     char(2),
        @c_discount   numeric(4,4),
        @i_price      numeric(5,2),
        @i_name       char(24),
        @i_data       char(50),
        @o_entry_d    datetime,
        @remote_flag  int,
        @s_quantity   smallint,
        @s_data       char(50),
        @s_dist       char(24),
        @li_no        int,
        @o_id         int,
        @commit_flag  tinyint,
        @li_id        int,
        @li_s_w_id    smallint,
        @li_qty       smallint,
        @ol_number    int,
        @c_id_local   int

begin

    begin transaction n

-- get district tax and next available order id and update
-- plus initialize local variables

        update district
        set          @d_tax      = d_tax,
                    @o_id       = d_next_o_id,
                    d_next_o_id = d_next_o_id + 1,
                    @o_entry_d  = getdate(),
                    @li_no      = 0,
                    @commit_flag = 1
        where        d_w_id      = @w_id and
                    d_id        = @d_id

-- process orderlines

        while (@li_no < @o_ol_cnt)
            begin

                select @li_no = @li_no + 1

-- set i_id, s_w_id, and qty for this lineitem

                select @li_id = case @li_no
                    when 1 then @i_id1
                    when 2 then @i_id2
                    when 3 then @i_id3
                    when 4 then @i_id4
                    when 5 then @i_id5
                    when 6 then @i_id6
                    when 7 then @i_id7
```

Appendix B - Database Design

```

when 8 then @i_id8
when 9 then @i_id9
when 10 then @i_id10
when 11 then @i_id11
when 12 then @i_id12
when 13 then @i_id13
when 14 then @i_id14
when 15 then @i_id15
end,

@li_s_w_id = case @li_no
when 1 then @s_w_id1
when 2 then @s_w_id2
when 3 then @s_w_id3
when 4 then @s_w_id4
when 5 then @s_w_id5
when 6 then @s_w_id6
when 7 then @s_w_id7
when 8 then @s_w_id8
when 9 then @s_w_id9
when 10 then @s_w_id10
when 11 then @s_w_id11
when 12 then @s_w_id12
when 13 then @s_w_id13
when 14 then @s_w_id14
when 15 then @s_w_id15
end,

@li_qty = case @li_no
when 1 then @ol_qty1
when 2 then @ol_qty2
when 3 then @ol_qty3
when 4 then @ol_qty4
when 5 then @ol_qty5
when 6 then @ol_qty6
when 7 then @ol_qty7
when 8 then @ol_qty8
when 9 then @ol_qty9
when 10 then @ol_qty10
when 11 then @ol_qty11
when 12 then @ol_qty12
when 13 then @ol_qty13
when 14 then @ol_qty14
when 15 then @ol_qty15
end

-- get item data (no one updates item)
select  @i_price = i_price,
        @i_name  = i_name,
        @i_data  = i_data
from    item (tablock repeatableread)
where   i_id = @li_id

-- update stock values
update  stock
set     s_ytd      = s_ytd + @li_qty,
        @s_quantity = s_quantity -
        @li_qty +
        case when (s_quantity - @li_qty < 10) then 91 else 0 end,
        s_order_cnt = s_order_cnt + 1,

```

```

s_remote_cnt = s_remote_cnt +
case when (@li_s_w_id = @w_id) then 0 else 1 end,
@s_data      = s_data,
@s_dist      = case @d_id
when 1
when 2 then s_dist_02
when 3 then s_dist_03
when 4 then s_dist_04
when 5 then s_dist_05
when 6 then s_dist_06
when 7 then s_dist_07
when 8 then s_dist_08
when 9 then s_dist_09
when 10 then s_dist_10
end
where   s_i_id      = @li_id and
        s_w_id      = @li_s_w_id

-- if there actually is a stock (and item) with these ids, go to work
if (@@rowcount > 0)
begin
-- insert order_line data (using data from item and stock)
insert into order_line values(@o_id,
@s_dist,
@w_id,
@li_no,
@li_id,
@li_s_w_id,
"dec 31, 1899",
@li_qty,
@i_price * @li_qty,
@s_dist)

-- send line-item data to client
select  @i_name,
@s_quantity,
b_g = case when (
(patindex("%ORIGINAL%",@i_data) > 0) and
(patindex("%ORIGINAL%",@s_data) > 0) )
then "B" else "G"
end,
@s_i_id,
@s_w_id,
@s_dist,
@s_data,
@s_remote_cnt,
@i_price,
@i_price * @li_qty
end
else

```

Appendix B - Database Design

```
begin
-- no item (or stock) found - triggers rollback condition
      select "",0,"",0,0
      select @commit_flag = 0
end
end
-- get customer last name, discount, and credit rating
select      @c_last      = c_last,
            @c_discount = c_discount,
            @c_credit   = c_credit,
            @c_id_local = c_id
from customer (repeatableread)
where c_id      = @c_id and
      c_w_id    = @w_id and
      c_d_id    = @d_id
-- insert fresh row into orders table
insert into orders values (@o_id,
                          @d_id,
                          @w_id,
                          @c_id_local,
                          @o_entry_d,
                          0,
                          @o_ol_cnt,
                          @o_all_local)
-- insert corresponding row into new-order table
insert into new_order values (@o_id,
                              @d_id,
                              @w_id)
-- select warehouse tax
select      @w_tax = w_tax
from warehouse (repeatableread)
where      w_id = @w_id
if (@commit_flag = 1)
    commit transaction n
else
-- all that work for nuthin!!!
    rollback transaction n
-- return order data to client
select @w_tax,
       @d_tax,
       @o_id,
       @c_last,
       @c_discount,
       @c_credit,
       @o_entry_d,
       @commit_flag
```

```
end
go

payment.sql

-- File:      PAYMENT.SQL
--           Microsoft TPC-C Benchmark Kit Ver. 4.00
--           Copyright Microsoft, 1996
-- Purpose:   Creates payment transaction stored procedure

use tpcc
go
if exists (select name from sysobjects where name = "tpcc_payment" )
    drop procedure tpcc_payment
go
create proc tpcc_payment @w_id          smallint,
                        @c_w_id        smallint,
                        @h_amount       numeric(6,2),
                        @d_id           tinyint,
                        @c_d_id         tinyint,
                        @c_id           int,
                        @c_last         char(16) =
""
as
declare @w_street_1 char(20),
        @w_street_2 char(20),
        @w_city     char(20),
        @w_state    char(2),
        @w_zip      char(9),
        @w_name     char(10),
        @d_street_1 char(20),
        @d_street_2 char(20),
        @d_city     char(20),
        @d_state    char(2),
        @d_zip      char(9),
        @d_name     char(10),
        @c_first    char(16),
        @c_middle   char(2),
        @c_street_1 char(20),
        @c_street_2 char(20),
        @c_city     char(20),
        @c_state    char(2),
        @c_zip      char(9),
        @c_phone    char(16),
        @c_since    datetime,
        @c_credit   char(2),
        @c_credit_lim numeric(12,2),
        @c_balance  numeric(12,2),
        @c_discount numeric(4,4),
        @data       char(500),
        @c_data     char(500),
        @datetime   datetime,
        @w_ytd      numeric(12,2),
```

Appendix B - Database Design

```
@d_ytd          numeric(12,2),
@cnt            smallint,
@val           smallint,
@screen_data   char(200),
               @d_id_local   tinyint,
               @w_id_local   smallint,
               @c_id_local   int

select @screen_data = ""
begin tran p
-- get payment date
select @datetime = getdate()
if (@c_id = 0)
begin
-- get customer id and info using last name
select @cnt = count(*)
from customer (repeatableread)
where c_last = @c_last and
      c_w_id = @c_w_id and
      c_d_id = @c_d_id

select @val = (@cnt + 1) / 2
set rowcount @val

select @c_id = c_id
from customer (repeatableread)
where c_last = @c_last and
      c_w_id = @c_w_id and
      c_d_id = @c_d_id
order by c_last, c_first

set rowcount 0
end

-- get customer info and update balances
update customer set
@c_balance      = c_balance - @h_amount,
@c_payment_cnt  = c_payment_cnt + 1,
@c_ytd_payment = c_ytd_payment + @h_amount,
@c_first       = c_first,
@c_middle      = c_middle,
@c_last        = c_last,
@c_street_1    = c_street_1,
@c_street_2    = c_street_2,
@c_city        = c_city,
@c_state       = c_state,
@c_zip         = c_zip,
@c_phone       = c_phone,
@c_credit      = c_credit,
@c_credit_lim  = c_credit_lim,
@c_discount    = c_discount,
@c_since       = c_since,
@c_data        = c_data,
@c_id_local    = c_id
where c_id = @c_id and
```

```
      c_w_id = @c_w_id and
      c_d_id = @c_d_id
-- if customer has bad credit get some more info
if (@c_credit = "BC")
begin
-- compute new info
select @c_data = convert(char(5),@c_id) +
               convert(char(4),@c_d_id) +
               convert(char(5),@c_w_id) +
               convert(char(4),@d_id) +
               convert(char(5),@w_id) +
               convert(char(19),@h_amount) +
               substring(@data, 1, 458)
-- update customer info
update customer set
      c_data = @c_data
where c_id = @c_id and
      c_w_id = @c_w_id and
      c_d_id = @c_d_id

select @screen_data = substring (@c_data,1,200)
end

-- get district data and update year-to-date
update district
set d_ytd      = d_ytd + @h_amount,
@d_street_1   = d_street_1,
@d_street_2   = d_street_2,
@d_city       = d_city,
@d_state      = d_state,
@d_zip        = d_zip,
@d_name       = d_name,
@d_id_local   = d_id
where d_w_id = @w_id and
      d_id = @d_id

-- get warehouse data and update year-to-date
update warehouse
set w_ytd      = w_ytd + @h_amount,
@w_street_1   = w_street_1,
@w_street_2   = w_street_2,
@w_city       = w_city,
@w_state      = w_state,
@w_zip        = w_zip,
@w_name       = w_name,
@w_id_local   = w_id
where w_id = @w_id

-- create history record
insert into history values (@c_id_local,
                           @c_d_id,
                           @c_w_id,
                           @d_id_local,
```

Appendix B - Database Design

```
@w_id_local,
@datetime,
@h_amount,
+ " " + @d_name)
commit tran p
-- return data to client
select @c_id,
        @c_last,
        @datetime,
        @w_street_1,
        @w_street_2,
        @w_city,
        @w_state,
        @w_zip,
        @d_street_1,
        @d_street_2,
        @d_city,
        @d_state,
        @d_zip,
        @c_first,
        @c_middle,
        @c_street_1,
        @c_street_2,
        @c_city,
        @c_state,
        @c_zip,
        @c_phone,
        @c_since,
        @c_credit,
        @c_credit_lim,
        @c_discount,
        @c_balance,
        @screen_data
go
```

ordstat.sql

```
-- File:      ORDSTAT.SQL
--           Microsoft TPC-C Benchmark Kit Ver. 4.00
--           Copyright Microsoft, 1996
-- Purpose:   Creates order status transaction stored procedure

use tpcc
go

if exists ( select name from sysobjects where name = "tpcc_orderstatus" )
    drop procedure  tpcc_orderstatus
go

create proc tpcc_orderstatus @w_id          smallint,
```

```
        tinyint,
        int,
= ""
as
declare @c_balance      numeric(12,2),
        @c_first       char(16),
        @c_middle      char(2),
        @o_id          int,
        @o_entry_d     datetime,
        @o_carrier_id  smallint,
        @cnt           smallint
begin tran o
        if (@c_id = 0)
            begin
-- get customer id and info using last name
                select @cnt = (count(*)+1)/2
                    from customer (repeatableread)
                    where c_last = @c_last and
                          c_w_id = @w_id and
                          c_d_id = @d_id
                set rowcount @cnt
                select @c_id = c_id,
                    @c_balance = c_balance,
                    @c_first  = c_first,
                    @c_last   = c_last,
                    @c_middle = c_middle
                    from customer (repeatableread)
                    where c_last = @c_last and
                          c_w_id = @w_id and
                          c_d_id = @d_id
                    order by c_w_id, c_d_id, c_last, c_first
                set rowcount 0
            end
        else
            begin
-- get customer info if by id
                select @c_balance = c_balance,
                    @c_first  = c_first,
                    @c_middle = c_middle,
                    @c_last   = c_last
                    from customer (repeatableread)
                    where c_id = @c_id and
                          c_d_id = @d_id and
                          c_w_id = @w_id
                select @cnt = @@rowcount
            end
end
```

Appendix B - Database Design

```
-- if no such customer
    if (@cnt = 0)
    begin
        raiserror("Customer not found",18,1)
        goto custnotfound
    end
-- get order info
    select @o_id = o_id,
           @o_entry_d = o_entry_d,
           @o_carrier_id = o_carrier_id
    from orders (serializable)
    where o_c_id = @c_id and
          o_d_id = @d_id and
          o_w_id = @w_id
    order by o_id asc
-- select order lines for the current order
    select ol_supply_w_id,
           ol_i_id,
           ol_quantity,
           ol_amount,
           ol_delivery_d
    from order_line (repeatableread)
    where ol_o_id = @o_id and
          ol_d_id = @d_id and
          ol_w_id = @w_id

custnotfound:
commit tran o
-- return data to client
select @c_id,
       @c_last,
       @c_first,
       @c_middle,
       @o_entry_d,
       @o_carrier_id,
       @c_balance,
       @o_id

go
```

delivery.sql

```
-- File:      DELIVERY.SQL
-- Microsoft TPC-C Benchmark Kit Ver. 4.00
-- Copyright Microsoft, 1996
-- Purpose:   Creates delivery transaction stored procedure
```

```
use tpcc
go
if exists (select name from sysobjects where name = "tpcc_delivery" )
    drop procedure tpcc_delivery
go
create proc tpcc_delivery    @w_id            smallint,
                             @o_carrier_id    smallint
as
declare @d_id tinyint,
        @o_id int,
        @c_id int,
        @total numeric(12,2),
        @oid1 int,
        @oid2 int,
        @oid3 int,
        @oid4 int,
        @oid5 int,
        @oid6 int,
        @oid7 int,
        @oid8 int,
        @oid9 int,
        @oid10 int

select @d_id = 0
begin tran d
    while (@d_id < 10)
    begin
        select @d_id = @d_id + 1,
               @total = 0,
               @o_id = 0

                select top 1 @o_id = no_o_id
                from new_order (serializable uplock)
                where no_w_id = @w_id and
                      no_d_id = @d_id
                order by no_o_id asc

        if (@@rowcount <> 0)
        begin
-- claim the order for this district
            delete new_order
            where no_w_id = @w_id and
                  no_d_id = @d_id and
                  no_o_id = @o_id

-- set carrier_id on this order (and get customer id)
            update orders
            set o_carrier_id = @o_carrier_id,
                @c_id = o_c_id
            where o_w_id = @w_id and
                  o_d_id = @d_id and
                  o_id = @o_id
```

Appendix B - Database Design

```
-- set date in all lineitems for this order (and sum amounts)

update order_line
  set ol_delivery_d = getdate(),
      @total        = @total + ol_amount
where ol_w_id = @w_id and
      ol_d_id = @d_id and
      ol_o_id = @o_id

-- accumulate lineitem amounts for this order into customer

update customer
  set c_balance      = c_balance + @total,
      c_delivery_cnt = c_delivery_cnt + 1
where c_w_id = @w_id and
      c_d_id = @d_id and
      c_id   = @c_id

end

select @oid1 = case @d_id when 1 then @o_id else @oid1 end,
       @oid2 = case @d_id when 2 then @o_id else @oid2 end,
       @oid3 = case @d_id when 3 then @o_id else @oid3 end,
       @oid4 = case @d_id when 4 then @o_id else @oid4 end,
       @oid5 = case @d_id when 5 then @o_id else @oid5 end,
       @oid6 = case @d_id when 6 then @o_id else @oid6 end,
       @oid7 = case @d_id when 7 then @o_id else @oid7 end,
       @oid8 = case @d_id when 8 then @o_id else @oid8 end,
       @oid9 = case @d_id when 9 then @o_id else @oid9 end,
       @oid10 = case @d_id when 10 then @o_id else @oid10 end

end

commit tran d

-- return delivery data to client

select @oid1,
       @oid2,
       @oid3,
       @oid4,
       @oid5,
       @oid6,
       @oid7,
       @oid8,
       @oid9,
       @oid10

go
```

stocklev.sql

```
-- File:      STOCKLEV.SQL
--           Microsoft TPC-C Benchmark Kit Ver. 4.00
--           Copyright Microsoft, 1996
-- Purpose:   Creates stock level transaction stored procedure

use tpcc
go
```

```
if exists (select name from sysobjects where name = "tpcc_stocklevel" )
  drop procedure tpcc_stocklevel
go

create proc tpcc_stocklevel @w_id          smallint,
                           @d_id          tinyint,
                           @threshold     smallint

as

  declare @o_id_low int,
          @o_id_high int

  select @o_id_low = (d_next_o_id - 20),
         @o_id_high = (d_next_o_id - 1)
  from district
  where d_w_id = @w_id and
        d_id   = @d_id

  select count(distinct(s_i_id))
  from stock, order_line
  where ol_w_id = @w_id and
        ol_d_id = @d_id and
        ol_o_id between @o_id_low and @o_id_high and
        s_w_id = ol_w_id and
        s_i_id = ol_i_id and
        s_quantity < @threshold

go
```

Loader Source Code

tpcc.h

```
// File:      TPCC.H
//           Microsoft TPC-C Kit Ver. 4.00
//           Copyright Microsoft, 1996, 1997, 1998

// Purpose:   Header file for TPC-C database loader

// Build number of TPC Benchmark Kit
#define TPCKIT_VER "4.00"

// General headers
#include <windows.h>
#include <winbase.h>
#include <stdlib.h>
#include <stdio.h>
#include <process.h>
#include <stddef.h>
#include <stdarg.h>
#include <string.h>
```

Appendix B - Database Design

```

#include <time.h>
#include <sys\timeb.h>
#include <sys\types.h>

// ODBC headers
#include <sql.h>
#include <sqlext.h>
#include <odbcss.h>

// General constants
#define MILLI 1000
#define FALSE 0
#define TRUE 1
#define UNDEF
#define MINPRINTASCII 32
#define MAXPRINTASCII 126

// Default environment constants
#define SERVER ""
#define DATABASE "tpcc"
#define USER "sa"
#define PASSWORD ""

// Default loader arguments
#define BATCH 10000
#define DEFLOADPACKSIZE 32768
#define ORDERS_PER_DIST 3000
#define LOADER_RES_FILE "logs\\load.out"
#define LOADER_NURAND_C 123
#define DEF_STARTING_WAREHOUSE 1
#define BUILD_INDEX 1 // build both data
and indexes
#define INDEX_ORDER 1 // build indexes
before load
#define SCALE_DOWN 0 // build a normal scale
database
#define INDEX_SCRIPT_PATH "scripts"

typedef struct
{
    char *server;
    char *database;
    char *user;
    char *password;
    BOOL tables_all;
    // set if loading all tables
    BOOL table_item;
    // set if loading ITEM table specifically
    BOOL table_warehouse; // set if loading
WAREHOUSE, DISTRICT, and STOCK
    BOOL table_customer; // set if
loading CUSTOMER and HISTORY
    BOOL table_orders; // set if
loading NEW-ORDER, ORDERS, ORDER-LINE
    long num_warehouses;
    long batch;
    long verbose;
    long pack_size;
    char *loader_res_file;
    char *synch_servername;
    long case_sensitivity;
    long starting_warehouse;
    long build_index;

```

```

        long index_order;
        long scale_down;
        char *index_script_path;
    } TPCCLDR_ARGS;

// String length constants
#define SERVER_NAME_LEN 20
#define DATABASE_NAME_LEN 20
#define USER_NAME_LEN 20
#define PASSWORD_LEN 20
#define TABLE_NAME_LEN 20
#define I_DATA_LEN 50
#define I_NAME_LEN 24
#define BRAND_LEN 16
#define LAST_NAME_LEN 1
#define W_NAME_LEN 10
#define ADDRESS_LEN 20
#define STATE_LEN 2
#define ZIP_LEN 9
#define S_DIST_LEN 24
#define S_DATA_LEN 50
#define D_NAME_LEN 10
#define FIRST_NAME_LEN 16
#define MIDDLE_NAME_LEN 2
#define PHONE_LEN 16
#define CREDIT_LEN 2
#define C_DATA_LEN 500
#define H_DATA_LEN 24
#define DIST_INFO_LEN 24
#define MAX_OL_NEW_ORDER_ITEMS 15
#define MAX_OL_ORDER_STATUS_ITEMS 15
#define STATUS_LEN 25
#define OL_DIST_INFO_LEN 24
#define C_SINCE_LEN 23
#define H_DATE_LEN 23
#define OL_DELIVERY_D_LEN 23
#define O_ENTRY_D_LEN 23

// Functions in random.c
void seed();
long irand();
double drand();
void WUcreate();
short WURand();
long RandomNumber(long lower, long upper);

// Functions in getargs.c;
void GetArgsLoader();
void GetArgsLoaderUsage();

// Functions in time.c
long TimeNow();

// Functions in strings.c
void MakeAddress();
void LastName();
int MakeAlphaString();
int MakeOriginalAlphaString();
int MakeNumberString();
int MakeZipNumberString();
void InitString();
void InitAddress();

```

Appendix B - Database Design

```
void PaddString();
```

tpccldr.c

```
// File: TPCCLDR.C
// Microsoft TPC-C Kit Ver. 4.00
// Copyright Microsoft, 1996, 1997, 1998
// Purpose: Source file for TPC-C database loader

// Includes
#include "tpcc.h"
#include "search.h"

// Defines
#define MAXITEMS 100000
#define MAXITEMS_SCALE_DOWN 100
#define CUSTOMERS_PER_DISTRICT 3000
#define CUSTOMERS_SCALE_DOWN30
#define DISTRICT_PER_WAREHOUSE 10
#define ORDERS_PER_DISTRICT 3000
#define ORDERS_SCALE_DOWN 30
#define MAX_CUSTOMER_THREADS 2
#define MAX_ORDER_THREADS 3
#define MAX_MAIN_THREADS 4

// Functions declarations

void HandleErrorDBC (SQLHDBC hdbc1);

long NURand();
void LoadItem();
void LoadWarehouse();

void Stock();
void District();

void LoadCustomer();
void CustomerBufInit();
void CustomerBufLoad();
void LoadCustomerTable();
void LoadHistoryTable();

void LoadOrders();
void OrdersBufInit();
void OrdersBufLoad();
void LoadOrdersTable();
void LoadNewOrderTable();
void LoadOrderLineTable();
void GetPermutation();
void CheckForCommit();
void OpenConnections();
void BuildIndex();
void FormatDate ();
```

```
// Shared memory structures
```

```
typedef struct
{
    long ol;
    long ol_i_id;
    short ol_supply_w_id;
    short ol_quantity;
    double ol_amount;
    char ol_dist_info[DIST_INFO_LEN+1];
    char ol_delivery_d[OL_DELIVERY_D_LEN+1];
} ORDER_LINE_STRUCT;

typedef struct
{
    long o_id;
    short o_d_id;
    short o_w_id;
    long o_c_id;
    short o_carrier_id;
    short o_ol_cnt;
    short o_all_local;
    ORDER_LINE_STRUCT o_ol[15];
} ORDERS_STRUCT;

typedef struct
{
    long c_id;
    short c_d_id;
    short c_w_id;
    char c_first[FIRST_NAME_LEN+1];
    char c_middle[MIDDLE_NAME_LEN+1];
    char c_last[LAST_NAME_LEN+1];
    char c_street_1[ADDRESS_LEN+1];
    char c_street_2[ADDRESS_LEN+1];
    char c_city[ADDRESS_LEN+1];
    char c_state[STATE_LEN+1];
    char c_zip[ZIP_LEN+1];
    char c_phone[PHONE_LEN+1];
    char c_credit[CREDIT_LEN+1];
    double c_credit_lim;
    double c_discount;
    // fix to avoid ODBC float to numeric conversion problem.
    // double c_balance;
    char c_balance[6];

    double c_ytd_payment;
    short c_payment_cnt;
    short c_delivery_cnt;
    char c_data[C_DATA_LEN+1];
    double h_amount;
    char h_data[H_DATA_LEN+1];
} CUSTOMER_STRUCT;

typedef struct
{
    char c_last[LAST_NAME_LEN+1];
    char c_first[FIRST_NAME_LEN+1];
    long c_id;
} CUSTOMER_SORT_STRUCT;

typedef struct
{
```

Appendix B - Database Design

```
    long          time_start;
} LOADER_TIME_STRUCT;

// Global variables

char    szLastError[300];

HENV    henv;

HDBC    i_hdbc1;          // for ITEM table
HDBC    w_hdbc1;          // for WAREHOUSE, DISTRICT,
STOCK
HDBC    c_hdbc1;          // for CUSTOMER
HDBC    c_hdbc2;          // for HISTORY
HDBC    o_hdbc1;          // for ORDERS
HDBC    o_hdbc2;          // for NEW-ORDER

HDBC    o_hdbc3;          // for ORDER-LINE

HSTMT   i_hstmt1;
HSTMT   w_hstmt1;
HSTMT   c_hstmt1, c_hstmt2;
HSTMT   o_hstmt1, o_hstmt2, o_hstmt3;

ORDERS_STRUCT  orders_buf[ORDERS_PER_DISTRICT];
CUSTOMER_STRUCT customer_buf[CUSTOMERS_PER_DISTRICT];
long           orders_rows_loaded;
long           new_order_rows_loaded;
long           order_line_rows_loaded;
long           history_rows_loaded;
long           customer_rows_loaded;
long           stock_rows_loaded;
long           district_rows_loaded;
long           item_rows_loaded;
long           warehouse_rows_loaded;
long           main_time_start;
long           main_time_end;
long           max_items;
long           customers_per_district;
long           orders_per_district;
long           first_new_order;
long           last_new_order;

TPCCLDR_ARGS  *aptr, args;

//=====
//
// Function name: main
//
//=====

int main(int argc, char **argv)
{
    DWORD          dwThreadId[MAX_MAIN_THREADS];
    HANDLE         hThread[MAX_MAIN_THREADS];
    FILE           *fLoader;
    char           buffer[255];
    int            i;
```

```
    for (i=0; i<MAX_MAIN_THREADS; i++)
        hThread[i] = NULL;

    printf("\n*****");
    printf("\n*                               *");
    printf("\n*   Microsoft SQL Server         *");
    printf("\n*                               *");
    printf("\n*   TPC-C BENCHMARK KIT:   Database loader   *");
    printf("\n*   Version %s               *", TPCKIT_VER);
    printf("\n*                               *");
    printf("\n*****\n\n");

    // process command line arguments

    aptr = &args;
    GetArgsLoader(argc, argv, aptr);

    printf("Build interface is ODBC.\n");

    if (aptr->build_index == 0)
        printf("Data load only - no index creation.\n");
    else
        printf("Data load and index creation.\n");

    if (aptr->index_order == 0)
        printf("Clustered indexes will be created after bulk load.\n");
    else
        printf("Clustered indexes will be created before bulk load.\n");

    // set database scale values
    if (aptr->scale_down == 1)
    {
        printf("*** Scaled Down Database ***\n");
        max_items = MAXITEMS_SCALE_DOWN;
        customers_per_district = CUSTOMERS_SCALE_DOWN;
        orders_per_district = ORDERS_SCALE_DOWN;
        first_new_order = 0;
        last_new_order = 30;
    }
    else
    {
        max_items = MAXITEMS;
        customers_per_district = CUSTOMERS_PER_DISTRICT;
        orders_per_district = ORDERS_PER_DISTRICT;
        first_new_order = 2100;
        last_new_order = 3000;
    }

    // open connections to SQL Server

    OpenConnections();

    // open file for loader results
    fLoader = fopen(aptr->loader_res_file, "w");

    if (fLoader == NULL)
    {
        printf("Error, loader result file open failed.");
        exit(-1);
    }

    // start loading data
```

Appendix B - Database Design

```
sprintf(buffer,"TPC-C load started for %ld warehouses.\n",aptr->num_warehouses);

printf("%s",buffer);
fprintf(fLoader,"%s",buffer);

main_time_start = (TimeNow() / MILLI);

// start parallel load threads

if (aptr->tables_all || aptr->table_item)
{
    fprintf(fLoader, "\nStarting loader threads for: item\n");
    hThread[0] = CreateThread(NULL,
                                0,
(LPTHREAD_START_ROUTINE) LoadItem,
                                NULL,
                                0,
&dwThreadID[0]);
    if (hThread[0] == NULL)
    {
        printf("Error, failed in creating creating thread = 0.\n");
        exit(-1);
    }
}

if (aptr->tables_all || aptr->table_warehouse)
{
    fprintf(fLoader, "Starting loader threads for: warehouse\n");
    hThread[1] = CreateThread(NULL,
                                0,
(LPTHREAD_START_ROUTINE) LoadWarehouse,
                                NULL,
                                0,
&dwThreadID[1]);
    if (hThread[1] == NULL)
    {
        printf("Error, failed in creating creating thread = 1.\n");
        exit(-1);
    }
}

if (aptr->tables_all || aptr->table_customer)
{
    fprintf(fLoader, "Starting loader threads for: customer\n");
    hThread[2] = CreateThread(NULL,
                                0,
(LPTHREAD_START_ROUTINE) LoadCustomer,
                                NULL,
                                0,
&dwThreadID[2]);
```

```
    if (hThread[2] == NULL)
    {
        printf("Error, failed in creating creating main thread =
2.\n");
        exit(-1);
    }
}

if (aptr->tables_all || aptr->table_orders)
{
    fprintf(fLoader, "Starting loader threads for: orders\n");
    hThread[3] = CreateThread(NULL,
                                0,
(LPTHREAD_START_ROUTINE) LoadOrders,
                                NULL,
                                0,
&dwThreadID[3]);
    if (hThread[3] == NULL)
    {
        printf("Error, failed in creating creating main thread =
3.\n");
        exit(-1);
    }
}

// Wait for threads to finish...
for (i=0; i<MAX_MAIN_THREADS; i++)
{
    if (hThread[i] != NULL)
    {
        WaitForSingleObject( hThread[i], INFINITE );
        CloseHandle(hThread[i]);
        hThread[i] = NULL;
    }
}

main_time_end = (TimeNow() / MILLI);

sprintf(buffer,"\nTPC-C load completed successfully in %ld minutes.\n",
        (main_time_end - main_time_start)/60);

printf("%s",buffer);
fprintf(fLoader, "%s", buffer);

fclose(fLoader);

SQLFreeEnv(henv);

exit(0);

return 0;
}

//=====
//
// Function name: LoadItem
//
//=====
```

Appendix B - Database Design

```
void LoadItem()
{
    long          i_id;
    long          i_im_id;
    char          i_name[I_NAME_LEN+1];
    double        i_price;
    char          i_data[I_DATA_LEN+1];
    char          name[20];
    long          time_start;
    RETCODE       rc;
    DBINT         rcint;
    char          bcphint[128];

    // Seed with unique number
    seed(1);

    printf("Loading item table...\n");

    // if build index before load
    if ((aptr->build_index == 1) && (aptr->index_order == 1))
        BuildIndex("idxitmcl");

    InitString(i_name, I_NAME_LEN+1);
    InitString(i_data, I_DATA_LEN+1);

    sprintf(name, "%s.%s", aptr->database, "item");

    rc = bcp_init(i_hdbc1, name, NULL, "logs\\item.err", DB_IN);
    if (rc != SUCCEEDED)
        HandleErrorDBC(i_hdbc1);

    if ((aptr->build_index == 1) && (aptr->index_order == 1))
    {
        sprintf(bcphint, "tablock, order (i_id), ROWS_PER_BATCH = 10000");
        rc = bcp_control(i_hdbc1, BCPHINTS, (void*) bcphint);
        if (rc != SUCCEEDED)
            HandleErrorDBC(i_hdbc1);
    }

1); rc = bcp_bind(i_hdbc1, (BYTE *) &i_id, 0, SQL_VARLEN_DATA, NULL, 0, SQLINT4,
    if (rc != SUCCEEDED)
        HandleErrorDBC(i_hdbc1);

2); rc = bcp_bind(i_hdbc1, (BYTE *) &i_im_id, 0, SQL_VARLEN_DATA, NULL, 0, SQLINT4,
    if (rc != SUCCEEDED)
        HandleErrorDBC(i_hdbc1);

    rc = bcp_bind(i_hdbc1, (BYTE *) i_name, 0, I_NAME_LEN, NULL, 0, 0, 3);
    if (rc != SUCCEEDED)
        HandleErrorDBC(i_hdbc1);

4); rc = bcp_bind(i_hdbc1, (BYTE *) &i_price, 0, SQL_VARLEN_DATA, NULL, 0, SQLFLT8,
    if (rc != SUCCEEDED)
        HandleErrorDBC(i_hdbc1);

    rc = bcp_bind(i_hdbc1, (BYTE *) i_data, 0, I_DATA_LEN, NULL, 0, 0, 5);
    if (rc != SUCCEEDED)
        HandleErrorDBC(i_hdbc1);
}
```

```
time_start = (TimeNow() / MILLI);

item_rows_loaded = 0;

for (i_id = 1; i_id <= max_items; i_id++)
{
    i_im_id = RandomNumber(1L, 10000L);

    MakeAlphaString(14, 24, I_NAME_LEN, i_name);

    i_price = ((float) RandomNumber(100L, 10000L))/100.0;

    MakeOriginalAlphaString(26, 50, I_DATA_LEN, i_data, 10);

    rc = bcp_sendrow(i_hdbc1);
    if (rc != SUCCEEDED)
        HandleErrorDBC(i_hdbc1);

    item_rows_loaded++;
    CheckForCommit(i_hdbc1, i_hstmt1, item_rows_loaded, "item",
&time_start);
}

rcint = bcp_done(i_hdbc1);
if (rcint < 0)
    HandleErrorDBC(i_hdbc1);

printf("Finished loading item table.\n");

SQLFreeStmt(i_hstmt1, SQL_DROP);
SQLDisconnect(i_hdbc1);
SQLFreeConnect(i_hdbc1);

// if build index after load
if ((aptr->build_index == 1) && (aptr->index_order == 0))
    BuildIndex("idxitmcl");
}

//=====
// Function : LoadWarehouse
//
// Loads WAREHOUSE table and loads Stock and District as Warehouses are created
//=====

void LoadWarehouse()
{
    short w_id;
    char w_name[W_NAME_LEN+1];
    char w_street_1[ADDRESS_LEN+1];
    char w_street_2[ADDRESS_LEN+1];
    char w_city[ADDRESS_LEN+1];
    char w_state[STATE_LEN+1];
    char w_zip[ZIP_LEN+1];
    double w_tax;
    double w_ytd;
    char name[20];
    long time_start;
    RETCODE rc;
    DBINT rcint;
}
```

Appendix B - Database Design

```
char    bcp hint[128];

// Seed with unique number
seed(2);

printf("Loading warehouse table...\n");

// if build index before load...
if ((aptr->build_index == 1) && (aptr->index_order == 1))
    BuildIndex("idxwarcl");

InitString(w_name, W_NAME_LEN+1);
InitAddress(w_street_1, w_street_2, w_city, w_state, w_zip);

sprintf(name, "%s.%s", aptr->database, "warehouse");

rc = bcp_init(w_hdbc1, name, NULL, "logs\\whouse.err", DB_IN);
if (rc != SUCCEEDED)
    HandleErrorDBC(w_hdbc1);

if ((aptr->build_index == 1) && (aptr->index_order == 1))
{
    sprintf(bcp hint, "tablock, order (w_id), ROWS_PER_BATCH = %d", aptr-
>num_warehouses);
    rc = bcp_control(w_hdbc1, BCPHINTS, (void*) bcp hint);
    if (rc != SUCCEEDED)
        HandleErrorDBC(w_hdbc1);
}

rc = bcp_bind(w_hdbc1, (BYTE *) &w_id, 0, SQL_VARLEN_DATA, NULL, 0, SQLINT2,
1);
if (rc != SUCCEEDED)
    HandleErrorDBC(w_hdbc1);

rc = bcp_bind(w_hdbc1, (BYTE *) w_name, 0, W_NAME_LEN, NULL, 0, 0, 2);
if (rc != SUCCEEDED)
    HandleErrorDBC(w_hdbc1);

rc = bcp_bind(w_hdbc1, (BYTE *) w_street_1, 0, ADDRESS_LEN, NULL, 0, 0, 3);
if (rc != SUCCEEDED)
    HandleErrorDBC(w_hdbc1);

rc = bcp_bind(w_hdbc1, (BYTE *) w_street_2, 0, ADDRESS_LEN, NULL, 0, 0, 4);
if (rc != SUCCEEDED)
    HandleErrorDBC(w_hdbc1);

rc = bcp_bind(w_hdbc1, (BYTE *) w_city, 0, ADDRESS_LEN, NULL, 0, 0, 5);
if (rc != SUCCEEDED)
    HandleErrorDBC(w_hdbc1);

rc = bcp_bind(w_hdbc1, (BYTE *) w_state, 0, STATE_LEN, NULL, 0, 0, 6);
if (rc != SUCCEEDED)
    HandleErrorDBC(w_hdbc1);

rc = bcp_bind(w_hdbc1, (BYTE *) w_zip, 0, ZIP_LEN, NULL, 0, 0, 7);
if (rc != SUCCEEDED)
    HandleErrorDBC(w_hdbc1);

8);
rc = bcp_bind(w_hdbc1, (BYTE *) &w_tax, 0, SQL_VARLEN_DATA, NULL, 0, SQLFLT8,
if (rc != SUCCEEDED)
    HandleErrorDBC(w_hdbc1);
```

```
9);
rc = bcp_bind(w_hdbc1, (BYTE *) &w_ytd, 0, SQL_VARLEN_DATA, NULL, 0, SQLFLT8,
if (rc != SUCCEEDED)
    HandleErrorDBC(w_hdbc1);

time_start = (TimeNow() / MILLI);

warehouse_rows_loaded = 0;

for (w_id = (short)aptr->starting_warehouse; w_id <= aptr->num_warehouses;
w_id++)
{
    MakeAlphaString(6,10, W_NAME_LEN, w_name);
    MakeAddress(w_street_1, w_street_2, w_city, w_state, w_zip);
    w_tax = ((float) RandomNumber(0L,2000L))/10000.00;
    w_ytd = 300000.00;
    rc = bcp_sendrow(w_hdbc1);
    if (rc != SUCCEEDED)
        HandleErrorDBC(w_hdbc1);

    warehouse_rows_loaded++;
    CheckForCommit(w_hdbc1, i_hstmt1, warehouse_rows_loaded, "warehouse",
&time_start);
}

rcint = bcp_done(w_hdbc1);
if (rcint < 0)
    HandleErrorDBC(w_hdbc1);

printf("Finished loading warehouse table.\n");

// if build index after load...
if ((aptr->build_index == 1) && (aptr->index_order == 0))
    BuildIndex("idxwarcl");

stock_rows_loaded = 0;
district_rows_loaded = 0;

District();
Stock();

}

//=====
//
// Function : District
//
//=====

void District()
{
    short d_id;
    short d_w_id;
    char d_name[D_NAME_LEN+1];
    char d_street_1[ADDRESS_LEN+1];
    char d_street_2[ADDRESS_LEN+1];
    char d_city[ADDRESS_LEN+1];
```

Appendix B - Database Design

```
char d_state[STATE_LEN+1];
char d_zip[ZIP_LEN+1];
double d_tax;
double d_ytd;
char name[20];
long d_next_o_id;
long time_start;
int w_id;
RETCODE rc;
DBINT rcint;
char bcpint[128];

// Seed with unique number
seed(4);

printf("Loading district table...\n");

// build index before load
if ((aptr->build_index == 1) && (aptr->index_order == 1))
    BuildIndex("idxdiscl");

InitString(d_name, D_NAME_LEN+1);
InitAddress(d_street_1, d_street_2, d_city, d_state, d_zip);
sprintf(name, "%s.%s", aptr->database, "district");

rc = bcp_init(w_hdbc1, name, NULL, "logs\\district.err", DB_IN);
if (rc != SUCCEEDED)
    HandleErrorDBC(w_hdbc1);

if ((aptr->build_index == 1) && (aptr->index_order == 1))
{
    sprintf(bcpint, "tablock, order (d_w_id, d_id), ROWS_PER_BATCH =
%u", (aptr->num_warehouses * 10));
    rc = bcp_control(w_hdbc1, BCPHINTS, (void*) bcpint);
    if (rc != SUCCEEDED)
        HandleErrorDBC(w_hdbc1);
}

1); rc = bcp_bind(w_hdbc1, (BYTE *) &d_id, 0, SQL_VARLEN_DATA, NULL, 0, SQLINT2,
if (rc != SUCCEEDED)
    HandleErrorDBC(w_hdbc1);

2); rc = bcp_bind(w_hdbc1, (BYTE *) &d_w_id, 0, SQL_VARLEN_DATA, NULL, 0, SQLINT2,
if (rc != SUCCEEDED)
    HandleErrorDBC(w_hdbc1);

rc = bcp_bind(w_hdbc1, (BYTE *) d_name, 0, D_NAME_LEN, NULL, 0, 0, 3);
if (rc != SUCCEEDED)
    HandleErrorDBC(w_hdbc1);

rc = bcp_bind(w_hdbc1, (BYTE *) d_street_1, 0, ADDRESS_LEN, NULL, 0, 0, 4);
if (rc != SUCCEEDED)
    HandleErrorDBC(w_hdbc1);

rc = bcp_bind(w_hdbc1, (BYTE *) d_street_2, 0, ADDRESS_LEN, NULL, 0, 0, 5);
if (rc != SUCCEEDED)
    HandleErrorDBC(w_hdbc1);

rc = bcp_bind(w_hdbc1, (BYTE *) d_city, 0, ADDRESS_LEN, NULL, 0, 0, 6);
if (rc != SUCCEEDED)
    HandleErrorDBC(w_hdbc1);
```

```
rc = bcp_bind(w_hdbc1, (BYTE *) d_state, 0, STATE_LEN, NULL, 0, 0, 7);
if (rc != SUCCEEDED)
    HandleErrorDBC(w_hdbc1);

rc = bcp_bind(w_hdbc1, (BYTE *) d_zip, 0, ZIP_LEN, NULL, 0, 0, 8);
if (rc != SUCCEEDED)
    HandleErrorDBC(w_hdbc1);

9); rc = bcp_bind(w_hdbc1, (BYTE *) &d_tax, 0, SQL_VARLEN_DATA, NULL, 0, SQLFLT8,
if (rc != SUCCEEDED)
    HandleErrorDBC(w_hdbc1);

10); rc = bcp_bind(w_hdbc1, (BYTE *) &d_ytd, 0, SQL_VARLEN_DATA, NULL, 0, SQLFLT8,
if (rc != SUCCEEDED)
    HandleErrorDBC(w_hdbc1);

SQLINT4, rc = bcp_bind(w_hdbc1, (BYTE *) &d_next_o_id, 0, SQL_VARLEN_DATA, NULL, 0,
11);
if (rc != SUCCEEDED)
    HandleErrorDBC(w_hdbc1);

d_ytd = 30000.0;
d_next_o_id = orders_per_district+1;
time_start = (TimeNow() / MILLI);

for (w_id = aptr->starting_warehouse; w_id <= aptr->num_warehouses; w_id++)
{
    d_w_id = w_id;
    for (d_id = 1; d_id <= DISTRICT_PER_WAREHOUSE; d_id++)
    {
        MakeAlphaString(6,10,D_NAME_LEN, d_name);
        MakeAddress(d_street_1, d_street_2, d_city, d_state,
d_zip);

        d_tax = ((float) RandomNumber(0L,2000L))/10000.00;
        rc = bcp_sendrow(w_hdbc1);
        if (rc != SUCCEEDED)
            HandleErrorDBC(w_hdbc1);

        district_rows_loaded++;
        CheckForCommit(w_hdbc1, w_hstmt1, district_rows_loaded,
"district", &time_start);
    }
}

rcint = bcp_done(w_hdbc1);
if (rcint < 0)
    HandleErrorDBC(w_hdbc1);

printf("Finished loading district table.\n");

// if build index after load...
if ((aptr->build_index == 1) && (aptr->index_order == 0))
    BuildIndex("idxdiscl");
```

Appendix B - Database Design

```
    return;
}

//=====
//
// Function   : Stock
//
//=====

void Stock()
{
    long s_i_id;
    short s_w_id;
    short s_quantity;
    char s_dist_01[S_DIST_LEN+1];
    char s_dist_02[S_DIST_LEN+1];
    char s_dist_03[S_DIST_LEN+1];
    char s_dist_04[S_DIST_LEN+1];
    char s_dist_05[S_DIST_LEN+1];
    char s_dist_06[S_DIST_LEN+1];
    char s_dist_07[S_DIST_LEN+1];
    char s_dist_08[S_DIST_LEN+1];
    char s_dist_09[S_DIST_LEN+1];
    char s_dist_10[S_DIST_LEN+1];
    long s_ytd;
    short s_order_cnt;
    short s_remote_cnt;
    char s_data[S_DATA_LEN+1];
    short len;
    char name[20];
    long time_start;
    RETCODE rc;
    DBINT rcint;
    char bcphint[128];

    // Seed with unique number
    seed(3);

    // if build index before load...
    if ((aptr->build_index == 1) && (aptr->index_order == 1))
        BuildIndex("idxstkcl");

    sprintf(name, "%s..%s", aptr->database, "stock");

    rc = bcp_init(w_hdbc1, name, NULL, "logs\\stock.err", DB_IN);
    if (rc != SUCCEEDED)
        HandleErrorDBC(w_hdbc1);

    if ((aptr->build_index == 1) && (aptr->index_order == 1))
    {
        sprintf(bcphint, "tablock, order (s_i_id, s_w_id), ROWS_PER_BATCH =
%u", (aptr->num_warehouses * 100000));
        rc = bcp_control(w_hdbc1, BCPHINTS, (void*) bcphint);
        if (rc != SUCCEEDED)
            HandleErrorDBC(w_hdbc1);
    }

    rc = bcp_bind(w_hdbc1, (BYTE *) &s_i_id, 0, SQL_VARLEN_DATA, NULL, 0, SQLINT4,
1);
    if (rc != SUCCEEDED)
        HandleErrorDBC(w_hdbc1);
```

```
        bcp_bind(w_hdbc1, (BYTE *) &s_w_id, 0, SQL_VARLEN_DATA, NULL, 0, SQLINT2, 2);
        if (rc != SUCCEEDED)
            HandleErrorDBC(w_hdbc1);

        rc = bcp_bind(w_hdbc1, (BYTE *) &s_quantity, 0, SQL_VARLEN_DATA, NULL, 0,
SQLINT2, 3);
        if (rc != SUCCEEDED)
            HandleErrorDBC(w_hdbc1);

        rc = bcp_bind(w_hdbc1, (BYTE *) s_dist_01, 0, S_DIST_LEN, NULL, 0, 0, 4);
        if (rc != SUCCEEDED)
            HandleErrorDBC(w_hdbc1);

        rc = bcp_bind(w_hdbc1, (BYTE *) s_dist_02, 0, S_DIST_LEN, NULL, 0, 0, 5);
        if (rc != SUCCEEDED)
            HandleErrorDBC(w_hdbc1);

        rc = bcp_bind(w_hdbc1, (BYTE *) s_dist_03, 0, S_DIST_LEN, NULL, 0, 0, 6);
        if (rc != SUCCEEDED)
            HandleErrorDBC(w_hdbc1);

        rc = bcp_bind(w_hdbc1, (BYTE *) s_dist_04, 0, S_DIST_LEN, NULL, 0, 0, 7);
        if (rc != SUCCEEDED)
            HandleErrorDBC(w_hdbc1);

        rc = bcp_bind(w_hdbc1, (BYTE *) s_dist_05, 0, S_DIST_LEN, NULL, 0, 0, 8);
        if (rc != SUCCEEDED)
            HandleErrorDBC(w_hdbc1);

        rc = bcp_bind(w_hdbc1, (BYTE *) s_dist_06, 0, S_DIST_LEN, NULL, 0, 0, 9);
        if (rc != SUCCEEDED)
            HandleErrorDBC(w_hdbc1);

        rc = bcp_bind(w_hdbc1, (BYTE *) s_dist_07, 0, S_DIST_LEN, NULL, 0, 0, 10);
        if (rc != SUCCEEDED)
            HandleErrorDBC(w_hdbc1);

        rc = bcp_bind(w_hdbc1, (BYTE *) s_dist_08, 0, S_DIST_LEN, NULL, 0, 0, 11);
        if (rc != SUCCEEDED)
            HandleErrorDBC(w_hdbc1);

        rc = bcp_bind(w_hdbc1, (BYTE *) s_dist_09, 0, S_DIST_LEN, NULL, 0, 0, 12);
        if (rc != SUCCEEDED)
            HandleErrorDBC(w_hdbc1);

        rc = bcp_bind(w_hdbc1, (BYTE *) s_dist_10, 0, S_DIST_LEN, NULL, 0, 0, 13);
        if (rc != SUCCEEDED)
            HandleErrorDBC(w_hdbc1);

        rc = bcp_bind(w_hdbc1, (BYTE *) &s_ytd, 0, SQL_VARLEN_DATA, NULL, 0, SQLINT4,
14);
        if (rc != SUCCEEDED)
            HandleErrorDBC(w_hdbc1);

        rc = bcp_bind(w_hdbc1, (BYTE *) &s_order_cnt, 0, SQL_VARLEN_DATA, NULL, 0,
SQLINT2, 15);
        if (rc != SUCCEEDED)
            HandleErrorDBC(w_hdbc1);

        rc = bcp_bind(w_hdbc1, (BYTE *) &s_remote_cnt, 0, SQL_VARLEN_DATA, NULL, 0,
SQLINT2, 16);
        if (rc != SUCCEEDED)
            HandleErrorDBC(w_hdbc1);
```

Appendix B - Database Design

```
rc = bcp_bind(w_hdbc1, (BYTE *) s_data, 0, S_DATA_LEN, NULL, 0, 0, 17);
if (rc != SUCCEEDED)
    HandleErrorDBC(w_hdbc1);

s_ytd = s_order_cnt = s_remote_cnt = 0;

time_start = (TimeNow() / MILLI);

printf("...Loading stock table\n");

for (s_i_id=1; s_i_id <= max_items; s_i_id++)
{
    for (s_w_id = (short)aptr->starting_warehouse; s_w_id <= aptr-
>num_warehouses; s_w_id++)
    {
        s_quantity = (short)RandomNumber(10L,100L);
        len = MakeAlphaString(24,24,S_DIST_LEN, s_dist_01);
        len = MakeAlphaString(24,24,S_DIST_LEN, s_dist_02);
        len = MakeAlphaString(24,24,S_DIST_LEN, s_dist_03);
        len = MakeAlphaString(24,24,S_DIST_LEN, s_dist_04);
        len = MakeAlphaString(24,24,S_DIST_LEN, s_dist_05);
        len = MakeAlphaString(24,24,S_DIST_LEN, s_dist_06);
        len = MakeAlphaString(24,24,S_DIST_LEN, s_dist_07);
        len = MakeAlphaString(24,24,S_DIST_LEN, s_dist_08);
        len = MakeAlphaString(24,24,S_DIST_LEN, s_dist_09);
        len = MakeAlphaString(24,24,S_DIST_LEN, s_dist_10);

        len = MakeOriginalAlphaString(26,50, S_DATA_LEN,
s_data,10);

        rc = bcp_sendrow(w_hdbc1);
        if (rc != SUCCEEDED)
            HandleErrorDBC(w_hdbc1);

        stock_rows_loaded++;
        CheckForCommit(w_hdbc1, w_hstmt1, stock_rows_loaded,
"stock", &time_start);
    }
}

rcint = bcp_done(w_hdbc1);
if (rcint < 0)
    HandleErrorDBC(w_hdbc1);

printf("Finished loading stock table.\n");

SQLFreeStmt(w_hstmt1, SQL_DROP);
SQLDisconnect(w_hdbc1);
SQLFreeConnect(w_hdbc1);

// if build index after load...
if ((aptr->build_index == 1) && (aptr->index_order == 0))
    BuildIndex("idxstk1");

return;
}

//=====
```

```
//
// Function : LoadCustomer
//
//=====

void LoadCustomer()
{
    LOADER_TIME_STRUCT customer_time_start;
    LOADER_TIME_STRUCT history_time_start;
    short w_id;

    short d_id;

    DWORD dwThreadID[MAX_CUSTOMER_THREADS];
    HANDLE hThread[MAX_CUSTOMER_THREADS];
    char name[20];

    RETCODE rc;
    DBINT rcint;
    char bcphint[128];
    char cmd[256];
    char rc_l;
    // SQLRETURN rcnum, MsgLen;
    // SQLSMALLINT SqlState[6],
    // SQLCHAR
    // SQLMAX_MESSAGE_LENGTH;
    // SQLINTEGER NativeError;

    // Seed with unique number
    seed(5);

    printf("Loading customer and history tables...\n");

    // if build index before load...
    if ((aptr->build_index == 1) && (aptr->index_order == 1))
        BuildIndex("idxcus1");

    // Initialize bulk copy
    sprintf(name, "%s.%s", aptr->database, "customer");

    rc = bcp_init(c_hdbc1, name, NULL, "logs\\customer.err", DB_IN);
    if (rc != SUCCEEDED)
        HandleErrorDBC(c_hdbc1);

    if ((aptr->build_index == 1) && (aptr->index_order == 1))
    {
        sprintf(bcphint, "tablock, order (c_w_id, c_d_id, c_id),
ROWS_PER_BATCH = %u", (aptr->num_warehouses * 30000));
        rc = bcp_control(c_hdbc1, BCPHINTS, (void*) bcphint);
        if (rc != SUCCEEDED)
            HandleErrorDBC(c_hdbc1);
    }

    sprintf(name, "%s.%s", aptr->database, "history");

    rc = bcp_init(c_hdbc2, name, NULL, "logs\\history.err", DB_IN);
    if (rc != SUCCEEDED)
        HandleErrorDBC(c_hdbc2);

    sprintf(bcphint, "tablock");
    rc = bcp_control(c_hdbc2, BCPHINTS, (void*) bcphint);
    if (rc != SUCCEEDED)
        HandleErrorDBC(c_hdbc2);

    customer_rows_loaded = 0;
    history_rows_loaded = 0;
}
```

Appendix B - Database Design

```
CustomerBufInit();

customer_time_start.time_start = (TimeNow() / MILLI);
history_time_start.time_start = (TimeNow() / MILLI);

w_id++)
for (w_id = (short)aptr->starting_warehouse; w_id <= aptr->num_warehouses;
    {
    for (d_id = 1; d_id <= DISTRICT_PER_WAREHOUSE; d_id++)
    {
        CustomerBufLoad(d_id, w_id);
        // Start parallel loading threads here...
        // Start customer table thread
        printf("...Loading customer table for: d_id = %d, w_id =
%d\n", d_id, w_id);

        hThread[0] = CreateThread(NULL,
0,
(LPTHREAD_START_ROUTINE) LoadCustomerTable,
&customer_time_start,
0,
&dwThreadID[0]);

        if (hThread[0] == NULL)
        {
            printf("Error, failed in creating creating thread
= 0.\n");
            exit(-1);
        }
        // Start History table thread
        printf("...Loading history table for: d_id = %d, w_id =
%d\n", d_id, w_id);

        hThread[1] = CreateThread(NULL,
0,
(LPTHREAD_START_ROUTINE) LoadHistoryTable,
&history_time_start,
0,
&dwThreadID[1]);

        if (hThread[1] == NULL)
        {
            printf("Error, failed in creating creating thread
= 1.\n");
            exit(-1);
        }
    }
    }
```

```
WaitForSingleObject( hThread[0], INFINITE );
WaitForSingleObject( hThread[1], INFINITE );

if (CloseHandle(hThread[0]) == FALSE)
{
    printf("Error, failed in closing customer thread
handle with errno: %d\n", GetLastError());
}

if (CloseHandle(hThread[1]) == FALSE)
{
    printf("Error, failed in closing history thread
handle with errno: %d\n", GetLastError());
}

}

// flush the bulk connection
rcint = bcp_done(c_hdbc1);
if (rcint < 0)
    HandleErrorDBC(c_hdbc1);

rcint = bcp_done(c_hdbc2);
if (rcint < 0)
    HandleErrorDBC(c_hdbc2);

printf("Finished loading customer table.\n");

// if build index after load..
if ((aptr->build_index == 1) && (aptr->index_order == 0))
    BuildIndex("idxcuscl");

// build non-clustered index
if (aptr->build_index == 1)
    BuildIndex("idxcusnc");

// Output the NURAND used for the loader into C_FIRST for C_ID = 1,
// C_W_ID = 1, and C_D_ID = 1
sprintf(cmd, "isql -S%s -U%s -P%s -d%s -e -Q\"update customer set c_first =
'C_LOAD = %d' where c_id = 1 and c_w_id = 1 and c_d_id = 1\" > logs\\nurand_load.log",
aptr->server,
aptr->user,
aptr->password,
aptr->database,
LOADER_NURAND_C);

system(cmd);

SQLFreeStmt(c_hstmt1, SQL_DROP);
SQLDisconnect(c_hdbc1);
SQLFreeConnect(c_hdbc1);

SQLFreeStmt(c_hstmt2, SQL_DROP);
SQLDisconnect(c_hdbc2);
SQLFreeConnect(c_hdbc2);

return;
}
```

Appendix B - Database Design

```
//=====
//
// Function   : CustomerBufInit
//
//=====

void CustomerBufInit()
{
    int    i;

    for (i=0;i<customers_per_district;i++)
    {
        customer_buf[i].c_id = 0;
        customer_buf[i].c_d_id = 0;
        customer_buf[i].c_w_id = 0;

        strcpy(customer_buf[i].c_first,"");
        strcpy(customer_buf[i].c_middle,"");
        strcpy(customer_buf[i].c_last,"");
        strcpy(customer_buf[i].c_street_1,"");
        strcpy(customer_buf[i].c_street_2,"");
        strcpy(customer_buf[i].c_city,"");
        strcpy(customer_buf[i].c_state,"");
        strcpy(customer_buf[i].c_zip,"");
        strcpy(customer_buf[i].c_phone,"");
        strcpy(customer_buf[i].c_credit,"");

        customer_buf[i].c_credit_lim = 0;
        customer_buf[i].c_discount = (float) 0;

        // fix to avoid ODBC float to numeric conversion problem.
        // customer_buf[i].c_balance = 0;
        strcpy(customer_buf[i].c_balance,"");

        customer_buf[i].c_ytd_payment = 0;
        customer_buf[i].c_payment_cnt = 0;
        customer_buf[i].c_delivery_cnt = 0;

        strcpy(customer_buf[i].c_data,"");

        customer_buf[i].h_amount = 0;

        strcpy(customer_buf[i].h_data,"");

    }
}

//=====
//
// Function   : CustomerBufLoad
//
// Fills shared buffer for HISTORY and CUSTOMER
//=====

void CustomerBufLoad(int d_id, int w_id)
{
    long          i;
    CUSTOMER_SORT_STRUCT  c[CUSTOMERS_PER_DISTRICT];
```

```
for (i=0;i<customers_per_district;i++)
{
    if (i < 1000)
        LastName(i, c[i].c_last);
    else
        LastName(NURand(255,0,999,LOADER_NURAND_C), c[i].c_last);

    MakeAlphaString(8,16,FIRST_NAME_LEN, c[i].c_first);

    c[i].c_id = i+1;
}

printf("...Loading customer buffer for: d_id = %d, w_id = %d\n",
        d_id, w_id);

for (i=0;i<customers_per_district;i++)
{
    customer_buf[i].c_d_id = d_id;
    customer_buf[i].c_w_id = w_id;
    customer_buf[i].h_amount = 10.0;

    customer_buf[i].c_ytd_payment = 10.0;
    customer_buf[i].c_payment_cnt = 1;
    customer_buf[i].c_delivery_cnt = 0;

    // Generate CUSTOMER and HISTORY data

    customer_buf[i].c_id = c[i].c_id;
    strcpy(customer_buf[i].c_first, c[i].c_first);
    strcpy(customer_buf[i].c_last, c[i].c_last);

    customer_buf[i].c_middle[0] = 'O';
    customer_buf[i].c_middle[1] = 'E';

    MakeAddress(customer_buf[i].c_street_1,
                customer_buf[i].c_street_2,
                customer_buf[i].c_city,
                customer_buf[i].c_state,
                customer_buf[i].c_zip);

    MakeNumberString(16, 16, PHONE_LEN, customer_buf[i].c_phone);

    if (RandomNumber(1L, 100L) > 10)
        customer_buf[i].c_credit[0] = 'G';
    else
        customer_buf[i].c_credit[0] = 'B';
    customer_buf[i].c_credit[1] = 'C';

    customer_buf[i].c_credit_lim = 50000.0;
    customer_buf[i].c_discount = ((float) RandomNumber(0L, 5000L)) /
10000.0;

    // fix to avoid ODBC float to numeric conversion problem.
    // customer_buf[i].c_balance = -10.0;
    strcpy(customer_buf[i].c_balance,"-10.0");
```

Appendix B - Database Design

```
        MakeAlphaString(500, 500, C_DATA_LEN, customer_buf[i].c_data);

        // Generate HISTORY data
        MakeAlphaString(12, 24, H_DATA_LEN, customer_buf[i].h_data);
    }
}
//=====
//
// Function   : LoadCustomerTable
//
//=====

void LoadCustomerTable(LOADER_TIME_STRUCT *customer_time_start)
{
    int         i;
    long        c_id;
    short       c_d_id;
    short       c_w_id;
    char        c_first[FIRST_NAME_LEN+1];
    char        c_middle[MIDDLE_NAME_LEN+1];
    char        c_last[LAST_NAME_LEN+1];
    char        c_street_1[ADDRESS_LEN+1];
    char        c_street_2[ADDRESS_LEN+1];
    char        c_city[ADDRESS_LEN+1];
    char        c_state[STATE_LEN+1];
    char        c_zip[ZIP_LEN+1];
    char        c_phone[PHONE_LEN+1];
    char        c_credit[CREDIT_LEN+1];
    double      c_credit_lim;
    double      c_discount;

    // fix to avoid ODBC float to numeric conversion problem.
    // double      c_balance;
    char        c_balance[6];

    double      c_ytd_payment;
    short       c_payment_cnt;
    short       c_delivery_cnt;
    char        c_data[C_DATA_LEN+1];
    char        c_since[C_SINCE_LEN+1];
    RETCODE     rc;

    rc = bcp_bind(c_hdbc1, (BYTE *) &c_id, 0, SQL_VARLEN_DATA, NULL, 0, SQLINT4, 1);
    if (rc != SUCCEEDED)
        HandleErrorDBC(c_hdbc1);

    rc = bcp_bind(c_hdbc1, (BYTE *) &c_d_id, 0, SQL_VARLEN_DATA, NULL, 0, SQLINT2, 2);
    if (rc != SUCCEEDED)
        HandleErrorDBC(c_hdbc1);

    rc = bcp_bind(c_hdbc1, (BYTE *) &c_w_id, 0, SQL_VARLEN_DATA, NULL, 0, SQLINT2,
3);
    if (rc != SUCCEEDED)
        HandleErrorDBC(c_hdbc1);

    rc = bcp_bind(c_hdbc1, (BYTE *) c_first, 0, FIRST_NAME_LEN, NULL, 0, 0, 4);
    if (rc != SUCCEEDED)
        HandleErrorDBC(c_hdbc1);

    rc = bcp_bind(c_hdbc1, (BYTE *) c_middle, 0, MIDDLE_NAME_LEN, NULL, 0, 0, 5);
```

```
        if (rc != SUCCEEDED)
            HandleErrorDBC(c_hdbc1);

    rc = bcp_bind(c_hdbc1, (BYTE *) c_last, 0, LAST_NAME_LEN, NULL, 0, 0, 6);
    if (rc != SUCCEEDED)
        HandleErrorDBC(c_hdbc1);

    rc = bcp_bind(c_hdbc1, (BYTE *) c_street_1, 0, ADDRESS_LEN, NULL, 0, 0, 7);
    if (rc != SUCCEEDED)
        HandleErrorDBC(c_hdbc1);

    rc = bcp_bind(c_hdbc1, (BYTE *) c_street_2, 0, ADDRESS_LEN, NULL, 0, 0, 8);
    if (rc != SUCCEEDED)
        HandleErrorDBC(c_hdbc1);

    rc = bcp_bind(c_hdbc1, (BYTE *) c_city, 0, ADDRESS_LEN, NULL, 0, 0, 9);
    if (rc != SUCCEEDED)
        HandleErrorDBC(c_hdbc1);

    rc = bcp_bind(c_hdbc1, (BYTE *) c_state, 0, STATE_LEN, NULL, 0, 0, 10);
    if (rc != SUCCEEDED)
        HandleErrorDBC(c_hdbc1);

    rc = bcp_bind(c_hdbc1, (BYTE *) c_zip, 0, ZIP_LEN, NULL, 0, 0, 11);
    if (rc != SUCCEEDED)
        HandleErrorDBC(c_hdbc1);

    rc = bcp_bind(c_hdbc1, (BYTE *) c_phone, 0, PHONE_LEN, NULL, 0, 0, 12);
    if (rc != SUCCEEDED)
        HandleErrorDBC(c_hdbc1);

    rc = bcp_bind(c_hdbc1, (BYTE *) &c_since, 0, C_SINCE_LEN, NULL, 0,
SQLCHARACTER, 13);
    if (rc != SUCCEEDED)
        HandleErrorDBC(c_hdbc1);

    rc = bcp_bind(c_hdbc1, (BYTE *) c_credit, 0, CREDIT_LEN, NULL, 0, 0, 14);
    if (rc != SUCCEEDED)
        HandleErrorDBC(c_hdbc1);

    rc = bcp_bind(c_hdbc1, (BYTE *) &c_credit_lim, 0, SQL_VARLEN_DATA, NULL, 0, SQLFLT8,
15);
    if (rc != SUCCEEDED)
        HandleErrorDBC(c_hdbc1);

    rc = bcp_bind(c_hdbc1, (BYTE *) &c_discount, 0, SQL_VARLEN_DATA, NULL, 0, SQLFLT8,
16);
    if (rc != SUCCEEDED)
        HandleErrorDBC(c_hdbc1);

    // fix to avoid ODBC float to numeric conversion problem.
    // rc = bcp_bind(c_hdbc1, (BYTE *) &c_balance, 0, SQL_VARLEN_DATA, NULL, 0, SQLFLT8,
17);
    // if (rc != SUCCEEDED)
    //     HandleErrorDBC(c_hdbc1);
    rc = bcp_bind(c_hdbc1, (BYTE *) c_balance, 0, 5, NULL, 0, SQLCHARACTER, 17);
    if (rc != SUCCEEDED)
        HandleErrorDBC(c_hdbc1);

    rc = bcp_bind(c_hdbc1, (BYTE *) &c_ytd_payment, 0, SQL_VARLEN_DATA, NULL, 0, SQLFLT8,
18);
```

Appendix B - Database Design

```
        if (rc != SUCCEEDED)
            HandleErrorDBC(c_hdbc1);

    rc = bcp_bind(c_hdbc1, (BYTE *) &c_payment_cnt, 0, SQL_VARLEN_DATA, NULL, 0, SQLINT2,
19);
    if (rc != SUCCEEDED)
        HandleErrorDBC(c_hdbc1);

    rc = bcp_bind(c_hdbc1, (BYTE *) &c_delivery_cnt, 0, SQL_VARLEN_DATA, NULL, 0, SQLINT2,
20);
    if (rc != SUCCEEDED)
        HandleErrorDBC(c_hdbc1);

    rc = bcp_bind(c_hdbc1, (BYTE *) c_data, 0, 500, NULL, 0, 0, 21);
    if (rc != SUCCEEDED)
        HandleErrorDBC(c_hdbc1);

    for (i = 0; i < customers_per_district; i++)
    {
        c_id = customer_buf[i].c_id;
        c_d_id = customer_buf[i].c_d_id;
        c_w_id = customer_buf[i].c_w_id;

        strcpy(c_first, customer_buf[i].c_first);
        strcpy(c_middle, customer_buf[i].c_middle);
        strcpy(c_last, customer_buf[i].c_last);
        strcpy(c_street_1, customer_buf[i].c_street_1);
        strcpy(c_street_2, customer_buf[i].c_street_2);
        strcpy(c_city, customer_buf[i].c_city);
        strcpy(c_state, customer_buf[i].c_state);
        strcpy(c_zip, customer_buf[i].c_zip);
        strcpy(c_phone, customer_buf[i].c_phone);
        strcpy(c_credit, customer_buf[i].c_credit);

        FormatDate(&c_since);

        c_credit_lim = customer_buf[i].c_credit_lim;
        c_discount = customer_buf[i].c_discount;

        // fix to avoid ODBC float to numeric conversion problem.

        // c_balance = customer_buf[i].c_balance;
        strcpy(c_balance, customer_buf[i].c_balance);

        c_ytd_payment = customer_buf[i].c_ytd_payment;
        c_payment_cnt = customer_buf[i].c_payment_cnt;
        c_delivery_cnt = customer_buf[i].c_delivery_cnt;

        strcpy(c_data, customer_buf[i].c_data);

        // Send data to server
        rc = bcp_sendrow(c_hdbc1);
        if (rc != SUCCEEDED)
            HandleErrorDBC(c_hdbc1);

        customer_rows_loaded++;
        CheckForCommit(c_hdbc1, c_hstmt1, customer_rows_loaded, "customer",
&customer_time_start->time_start);
    }
}
```

```
=====
//
// Function : LoadHistoryTable
//
=====

void LoadHistoryTable(LOADER_TIME_STRUCT *history_time_start)
{
    int i;
    long c_id;
    short c_d_id;
    short c_w_id;
    double h_amount;
    char h_data[H_DATA_LEN+1];
    char h_date[H_DATE_LEN+1];
    RETCODE rc;

    rc = bcp_bind(c_hdbc2, (BYTE *) &c_id, 0, SQL_VARLEN_DATA, NULL, 0, SQLINT4, 1);
    if (rc != SUCCEEDED)
        HandleErrorDBC(c_hdbc2);

    rc = bcp_bind(c_hdbc2, (BYTE *) &c_d_id, 0, SQL_VARLEN_DATA, NULL, 0, SQLINT2, 2);
    if (rc != SUCCEEDED)
        HandleErrorDBC(c_hdbc2);

    rc = bcp_bind(c_hdbc2, (BYTE *) &c_w_id, 0, SQL_VARLEN_DATA, NULL, 0, SQLINT2, 3);
    if (rc != SUCCEEDED)
        HandleErrorDBC(c_hdbc2);

    rc = bcp_bind(c_hdbc2, (BYTE *) &c_d_id, 0, SQL_VARLEN_DATA, NULL, 0, SQLINT2, 4);
    if (rc != SUCCEEDED)
        HandleErrorDBC(c_hdbc2);

    rc = bcp_bind(c_hdbc2, (BYTE *) &c_w_id, 0, SQL_VARLEN_DATA, NULL, 0, SQLINT2, 5);
    if (rc != SUCCEEDED)
        HandleErrorDBC(c_hdbc2);

    rc = bcp_bind(c_hdbc2, (BYTE *) &h_date, 0, H_DATE_LEN, NULL, 0, SQLCHARACTER,
6);
    if (rc != SUCCEEDED)
        HandleErrorDBC(c_hdbc2);

    rc = bcp_bind(c_hdbc2, (BYTE *) &h_amount, 0, SQL_VARLEN_DATA, NULL, 0, SQLFLT8, 7);
    if (rc != SUCCEEDED)
        HandleErrorDBC(c_hdbc2);

    rc = bcp_bind(c_hdbc2, (BYTE *) h_data, 0, H_DATA_LEN, NULL, 0, 0, 8);
    if (rc != SUCCEEDED)
        HandleErrorDBC(c_hdbc2);

    for (i = 0; i < customers_per_district; i++)
    {
        c_id = customer_buf[i].c_id;
        c_d_id = customer_buf[i].c_d_id;
        c_w_id = customer_buf[i].c_w_id;
        h_amount = customer_buf[i].h_amount;
        strcpy(h_data, customer_buf[i].h_data);

        FormatDate(&h_date);

        // send to server
        rc = bcp_sendrow(c_hdbc2);
        if (rc != SUCCEEDED)

```

Appendix B - Database Design

```
        HandleErrorDBC(o_hdbc2);

        history_rows_loaded++;
        CheckForCommit(c_hdbc2, c_hstmt2, history_rows_loaded, "history",
&history_time_start->time_start);
    }
}

//=====
//
// Function   : LoadOrders
//
//=====

void LoadOrders()
{
    LOADER_TIME_STRUCT    orders_time_start;
    LOADER_TIME_STRUCT    new_order_time_start;
    LOADER_TIME_STRUCT    order_line_time_start;
    short                 w_id;

    short                 d_id;
    DWORD                 dwThreadID[MAX_ORDER_THREADS];
    HANDLE                 hThread[MAX_ORDER_THREADS];
    char                  name[20];
    RETCODE                rc;
    char                  bcphint[128];

    // seed with unique number
    seed(6);

    printf("Loading orders...\n");

    // if build index before load...
    if ((aptr->build_index == 1) && (aptr->index_order == 1))
    {
        BuildIndex("idxordc1");
        BuildIndex("idxnodc1");
        BuildIndex("idxodlc1");
    }

    // initialize bulk copy
    sprintf(name, "%s..%s", aptr->database, "orders");

    rc = bcp_init(o_hdbc1, name, NULL, "logs\\orders.err", DB_IN);
    if (rc != SUCCEED)
        HandleErrorDBC(o_hdbc1);

    if ((aptr->build_index == 1) && (aptr->index_order == 1))
    {
        sprintf(bcphint, "tablock, order (o_w_id, o_d_id, o_id),
ROWS_PER_BATCH = %u", (aptr->num_warehouses * 30000));
        rc = bcp_control(o_hdbc1, BCPHINTS, (void*) bcphint);
        if (rc != SUCCEED)
            HandleErrorDBC(o_hdbc1);
    }

    sprintf(name, "%s..%s", aptr->database, "new_order");

    rc = bcp_init(o_hdbc2, name, NULL, "logs\\neword.err", DB_IN);
    if (rc != SUCCEED)
        HandleErrorDBC(o_hdbc2);
```

```
    if ((aptr->build_index == 1) && (aptr->index_order == 1))
    {
        sprintf(bcphint, "tablock, order (no_w_id, no_d_id, no_o_id),
ROWS_PER_BATCH = %u", (aptr->num_warehouses * 9000));
        rc = bcp_control(o_hdbc2, BCPHINTS, (void*) bcphint);
        if (rc != SUCCEED)
            HandleErrorDBC(o_hdbc2);
    }

    sprintf(name, "%s..%s", aptr->database, "order_line");

    rc = bcp_init(o_hdbc3, name, NULL, "logs\\ordline.err", DB_IN);
    if (rc != SUCCEED)
        HandleErrorDBC(o_hdbc3);

    if ((aptr->build_index == 1) && (aptr->index_order == 1))
    {
        sprintf(bcphint, "tablock, order (ol_w_id, ol_d_id, ol_o_id,
ol_number), ROWS_PER_BATCH = %u", (aptr->num_warehouses * 300000));
        rc = bcp_control(o_hdbc3, BCPHINTS, (void*) bcphint);
        if (rc != SUCCEED)
            HandleErrorDBC(o_hdbc3);
    }

    orders_rows_loaded      = 0;
    new_order_rows_loaded   = 0;
    order_line_rows_loaded  = 0;

    OrdersBufInit();

    orders_time_start.time_start = (TimeNow() / MILLI);
    new_order_time_start.time_start = (TimeNow() / MILLI);
    order_line_time_start.time_start = (TimeNow() / MILLI);

    for (w_id = (short)aptr->starting_warehouse; w_id <= aptr->num_warehouses;
w_id++)
    {
        for (d_id = 1; d_id <= DISTRICT_PER_WAREHOUSE; d_id++)
        {
            OrdersBufLoad(d_id, w_id);

            // start parallel loading threads here...

            // start Orders table thread
            printf("...Loading Order Table for: d_id = %d, w_id =
%d\n", d_id, w_id);

            hThread[0] = CreateThread(NULL,
0,
(LPTHREAD_START_ROUTINE) LoadOrdersTable,
&orders_time_start,
0,
&dwThreadID[0]);

            if (hThread[0] == NULL)
```

Appendix B - Database Design

```
    {
        printf("Error, failed in creating creating thread
= 0.\n");
        exit(-1);
    }
    // start NewOrder table thread
    printf("...Loading New-Order Table for: d_id = %d, w_id =
%d\n", d_id, w_id);
    hThread[1] = CreateThread(NULL,
0,
(LPTHREAD_START_ROUTINE) LoadNewOrderTable,
&new_order_time_start,
0,
&dwThreadID[1]);
    if (hThread[1] == NULL)
    {
        printf("Error, failed in creating creating thread
= 1.\n");
        exit(-1);
    }
    // start Order-Line table thread
    printf("...Loading Order-Line Table for: d_id = %d, w_id =
%d\n", d_id, w_id);
    hThread[2] = CreateThread(NULL,
0,
(LPTHREAD_START_ROUTINE) LoadOrderLineTable,
&order_line_time_start,
0,
&dwThreadID[2]);
    if (hThread[2] == NULL)
    {
        printf("Error, failed in creating creating thread
= 2.\n");
        exit(-1);
    }
    WaitForSingleObject( hThread[0], INFINITE );
    WaitForSingleObject( hThread[1], INFINITE );
    WaitForSingleObject( hThread[2], INFINITE );
    if (CloseHandle(hThread[0]) == FALSE)
    {
        printf("Error, failed in closing Orders thread
handle with errno: %d\n", GetLastError());
    }
}
```

```
        if (CloseHandle(hThread[1]) == FALSE)
        {
            printf("Error, failed in closing NewOrder thread
handle with errno: %d\n", GetLastError());
        }
        if (CloseHandle(hThread[2]) == FALSE)
        {
            printf("Error, failed in closing OrderLine thread
handle with errno: %d\n", GetLastError());
        }
    }
    printf("Finished loading orders.\n");

return;
}

//=====
//
// Function   : OrdersBufInit
// Clears shared buffer for ORDERS, NEWORDER, and ORDERLINE
//
//=====
void OrdersBufInit()
{
    int    i;
    int    j;

    for (i=0;i<orders_per_district;i++)
    {
        orders_buf[i].o_oid = 0;
        orders_buf[i].o_d_id = 0;
        orders_buf[i].o_w_id = 0;
        orders_buf[i].o_c_id = 0;
        orders_buf[i].o_carrier_id = 0;
        orders_buf[i].o_ol_cnt = 0;
        orders_buf[i].o_all_local = 0;

        for (j=0;j<=14;j++)
        {
            orders_buf[i].o_ol[j].ol = 0;
            orders_buf[i].o_ol[j].ol_i_id = 0;
            orders_buf[i].o_ol[j].ol_supply_w_id = 0;
            orders_buf[i].o_ol[j].ol_quantity = 0;
            orders_buf[i].o_ol[j].ol_amount = 0;
            strcpy(orders_buf[i].o_ol[j].ol_dist_info,"");
        }
    }
}

//=====
//
```

Appendix B - Database Design

```
// Function : OrdersBufLoad
//
// Fills shared buffer for ORDERS, NEWORDER, and ORDERLINE
//
//=====
void OrdersBufLoad(int d_id, int w_id)
{
    int    cust[ORDERS_PER_DIST+1];
    long   o_id;
    short  ol;

    printf("...Loading Order Buffer for: d_id = %d, w_id = %d\n",
           d_id, w_id);

    GetPermutation(cust, ORDERS_PER_DIST);

    for (o_id=0;o_id<orders_per_district;o_id++)
    {
        // Generate ORDER and NEW-ORDER data

        orders_buf[o_id].o_d_id = d_id;
        orders_buf[o_id].o_w_id = w_id;
        orders_buf[o_id].o_id = o_id+1;
        orders_buf[o_id].o_c_id = cust[o_id+1];
        orders_buf[o_id].o_ol_cnt = (short)RandomNumber(5L, 15L);

        if (o_id < first_new_order)
        {
            orders_buf[o_id].o_carrier_id = (short)RandomNumber(1L,
10L);
            orders_buf[o_id].o_all_local = 1;
        }
        else
        {
            orders_buf[o_id].o_carrier_id = 0;
            orders_buf[o_id].o_all_local = 1;
        }

        for (ol=0; ol<orders_buf[o_id].o_ol_cnt; ol++)
        {
            orders_buf[o_id].o_ol[ol].ol = ol+1;
            orders_buf[o_id].o_ol[ol].ol_i_id = RandomNumber(1L,
max_items);
            orders_buf[o_id].o_ol[ol].ol_supply_w_id = w_id;
            orders_buf[o_id].o_ol[ol].ol_quantity = 5;
            MakeAlphaString(24, 24, OL_DIST_INFO_LEN,
&orders_buf[o_id].o_ol[ol].ol_dist_info);

            // Generate ORDER-LINE data
            if (o_id < first_new_order)
            {
                orders_buf[o_id].o_ol[ol].ol_amount = 0;
                // Added to insure ol_delivery_d set properly

                during load

                FormatDate(&orders_buf[o_id].o_ol[ol].ol_delivery_d);
            }
        }
    }
}
```

```
        else
        {
            orders_buf[o_id].o_ol[ol].ol_amount =
RandomNumber(1,999999)/100.0;
            // Added to insure ol_delivery_d set properly
            during load

            // odbc datetime format

            strcpy(orders_buf[o_id].o_ol[ol].ol_delivery_d,"1899-12-31 12:00:00.000");
        }
    }
}

//=====
//
// Function : LoadOrdersTable
//
//=====
void LoadOrdersTable(LOADER_TIME_STRUCT *orders_time_start)
{
    int    i;
    long   o_id;
    short  o_d_id;
    short  o_w_id;
    long   o_c_id;
    short  o_carrier_id;
    short  o_ol_cnt;
    short  o_all_local;
    char   o_entry_d[O_ENTRY_D_LEN+1];
    RETCODE rc;
    DBINT   rcint;

    // bind ORDER data
    rc = bcp_bind(o_hdbc1, (BYTE *) &o_id, 0, SQL_VARLEN_DATA, NULL, 0, SQLINT4, 1);
    if (rc != SUCCEED)
        HandleErrorDBC(o_hdbc1);

    rc = bcp_bind(o_hdbc1, (BYTE *) &o_d_id, 0, SQL_VARLEN_DATA, NULL, 0, SQLINT2, 2);
    if (rc != SUCCEED)
        HandleErrorDBC(o_hdbc1);

    rc = bcp_bind(o_hdbc1, (BYTE *) &o_w_id, 0, SQL_VARLEN_DATA, NULL, 0, SQLINT2, 3);
    if (rc != SUCCEED)
        HandleErrorDBC(o_hdbc1);

    rc = bcp_bind(o_hdbc1, (BYTE *) &o_c_id, 0, SQL_VARLEN_DATA, NULL, 0, SQLINT4, 4);
    if (rc != SUCCEED)
        HandleErrorDBC(o_hdbc1);

    rc = bcp_bind(o_hdbc1, (BYTE *) &o_entry_d, 0, O_ENTRY_D_LEN, NULL, 0,
SQLCHARACTER, 5);
    if (rc != SUCCEED)
        HandleErrorDBC(o_hdbc1);

    rc = bcp_bind(o_hdbc1, (BYTE *) &o_carrier_id, 0, SQL_VARLEN_DATA, NULL, 0, SQLINT2,
6);
    if (rc != SUCCEED)
        HandleErrorDBC(o_hdbc1);
}
```

Appendix B - Database Design

```
rc = bcp_bind(o_hdbc1, (BYTE *) &o_ol_cnt, 0, SQL_VARLEN_DATA, NULL, 0, SQLINT2, 7);
if (rc != SUCCEEDED)
    HandleErrorDBC(o_hdbc1);

rc = bcp_bind(o_hdbc1, (BYTE *) &o_all_local, 0, SQL_VARLEN_DATA, NULL, 0, SQLINT2,
8);
if (rc != SUCCEEDED)
    HandleErrorDBC(o_hdbc1);

for (i = 0; i < orders_per_district; i++)
{
    o_id      = orders_buf[i].o_id;
    o_d_id    = orders_buf[i].o_d_id;
    o_w_id    = orders_buf[i].o_w_id;
    o_c_id    = orders_buf[i].o_c_id;
    o_carrier_id = orders_buf[i].o_carrier_id;
    o_ol_cnt  = orders_buf[i].o_ol_cnt;
    o_all_local = orders_buf[i].o_all_local;

    FormatDate(&o_entry_d);

    // send data to server
    rc = bcp_sendrow(o_hdbc1);
    if (rc != SUCCEEDED)
        HandleErrorDBC(o_hdbc1);

    orders_rows_loaded++;
    CheckForCommit(o_hdbc1, o_hstmt1, orders_rows_loaded, "orders",
&orders_time_start->time_start);
}

// rcint = bcp_batch(o_hdbc1);
// if (rcint < 0)
//     HandleErrorDBC(o_hdbc1);

if ((o_w_id == aptr->num_warehouses) && (o_d_id == 10))
{
    rcint = bcp_done(o_hdbc1);
    if (rcint < 0)
        HandleErrorDBC(o_hdbc1);

    SQLFreeStmt(o_hstmt1, SQL_DROP);
    SQLDisconnect(o_hdbc1);
    SQLFreeConnect(o_hdbc1);

    // if build index after load...
    if ((aptr->build_index == 1) && (aptr->index_order == 0))
        BuildIndex("idxordc1");

    // build non-clustered index
    if (aptr->build_index == 1)
        BuildIndex("idxordnc");
}

}

//=====
//
// Function    : LoadNewOrderTable
//
//=====
```

```
void LoadNewOrderTable(LOADER_TIME_STRUCT *new_order_time_start)
{
    int      i;
    long     o_id;
    short    o_d_id;
    short    o_w_id;

    RETCODE  rc;
    DBINT    rcint;

    // Bind NEW-ORDER data

    rc = bcp_bind(o_hdbc2, (BYTE *) &o_id, 0, SQL_VARLEN_DATA, NULL, 0, SQLINT4, 1);
    if (rc != SUCCEEDED)
        HandleErrorDBC(o_hdbc2);

    rc = bcp_bind(o_hdbc2, (BYTE *) &o_d_id, 0, SQL_VARLEN_DATA, NULL, 0, SQLINT2, 2);
    if (rc != SUCCEEDED)
        HandleErrorDBC(o_hdbc2);

    rc = bcp_bind(o_hdbc2, (BYTE *) &o_w_id, 0, SQL_VARLEN_DATA, NULL, 0, SQLINT2, 3);
    if (rc != SUCCEEDED)
        HandleErrorDBC(o_hdbc2);

    for (i = first_new_order; i < last_new_order; i++)
    {
        o_id  = orders_buf[i].o_id;
        o_d_id = orders_buf[i].o_d_id;
        o_w_id = orders_buf[i].o_w_id;

        rc = bcp_sendrow(o_hdbc2);
        if (rc != SUCCEEDED)
            HandleErrorDBC(o_hdbc2);

        new_order_rows_loaded++;
        CheckForCommit(o_hdbc2, o_hstmt2, new_order_rows_loaded, "new_order",
&new_order_time_start->time_start);
    }

    // rcint = bcp_batch(o_hdbc2);
    // if (rcint < 0)
    //     HandleErrorDBC(o_hdbc2);

    if ((o_w_id == aptr->num_warehouses) && (o_d_id == 10))
    {
        rcint = bcp_done(o_hdbc2);
        if (rcint < 0)
            HandleErrorDBC(o_hdbc2);

        SQLFreeStmt(o_hstmt2, SQL_DROP);
        SQLDisconnect(o_hdbc2);
        SQLFreeConnect(o_hdbc2);

        // if build index after load...
        if ((aptr->build_index == 1) && (aptr->index_order == 0))
            BuildIndex("idxnodc1");
    }

}

//=====
```

Appendix B - Database Design

```
//
// Function   : LoadOrderLineTable
//
//=====
void LoadOrderLineTable(LOADER_TIME_STRUCT *order_line_time_start)
{
    int         i,j;
    long        o_id;
    short       o_d_id;
    short       o_w_id;
    long        ol;
    long        ol_i_id;
    short       ol_supply_w_id;
    short       ol_quantity;
    double      ol_amount;
    char        ol_dist_info[DIST_INFO_LEN+1];
    char        ol_delivery_d[OL_DELIVERY_D_LEN+1];
    RETCODE     rc;
    DBINT       rcint;

    // bind ORDER-LINE data
    rc = bcp_bind(o_hdbc3, (BYTE *) &o_id, 0, SQL_VARLEN_DATA, NULL, 0, SQLINT4, 1);
    if (rc != SUCCEEDED)
        HandleErrorDBC(o_hdbc3);

    rc = bcp_bind(o_hdbc3, (BYTE *) &o_d_id, 0, SQL_VARLEN_DATA, NULL, 0, SQLINT2, 2);
    if (rc != SUCCEEDED)
        HandleErrorDBC(o_hdbc3);

    rc = bcp_bind(o_hdbc3, (BYTE *) &o_w_id, 0, SQL_VARLEN_DATA, NULL, 0, SQLINT2, 3);
    if (rc != SUCCEEDED)
        HandleErrorDBC(o_hdbc3);

    rc = bcp_bind(o_hdbc3, (BYTE *) &ol, 0, SQL_VARLEN_DATA, NULL, 0, SQLINT4, 4);
    if (rc != SUCCEEDED)
        HandleErrorDBC(o_hdbc3);

    rc = bcp_bind(o_hdbc3, (BYTE *) &ol_i_id, 0, SQL_VARLEN_DATA, NULL, 0, SQLINT4, 5);
    if (rc != SUCCEEDED)
        HandleErrorDBC(o_hdbc3);

    rc = bcp_bind(o_hdbc3, (BYTE *) &ol_supply_w_id, 0, SQL_VARLEN_DATA, NULL, 0,
SQLINT2, 6);
    if (rc != SUCCEEDED)
        HandleErrorDBC(o_hdbc3);

    rc = bcp_bind(o_hdbc3, (BYTE *) &ol_delivery_d, 0, OL_DELIVERY_D_LEN, NULL, 0,
SQLCHARACTER, 7);
    if (rc != SUCCEEDED)
        HandleErrorDBC(o_hdbc3);

    rc = bcp_bind(o_hdbc3, (BYTE *) &ol_quantity, 0, SQL_VARLEN_DATA, NULL, 0, SQLINT2,
8);
    if (rc != SUCCEEDED)
        HandleErrorDBC(o_hdbc3);

    rc = bcp_bind(o_hdbc3, (BYTE *) &ol_amount, 0, SQL_VARLEN_DATA, NULL, 0, SQLFLT8, 9);
    if (rc != SUCCEEDED)
        HandleErrorDBC(o_hdbc3);

    rc = bcp_bind(o_hdbc3, (BYTE *) ol_dist_info, 0, DIST_INFO_LEN, NULL, 0, 0, 10);
    if (rc != SUCCEEDED)
```

```
        HandleErrorDBC(o_hdbc3);

    for (i = 0; i < orders_per_district; i++)
    {
        o_id   = orders_buf[i].o_id;
        o_d_id = orders_buf[i].o_d_id;
        o_w_id = orders_buf[i].o_w_id;

        for (j=0; j < orders_buf[i].o_ol_cnt; j++)
        {
            ol         = orders_buf[i].o_ol[j].ol;
            ol_i_id    = orders_buf[i].o_ol[j].ol_i_id;
            ol_supply_w_id = orders_buf[i].o_ol[j].ol_supply_w_id;
            ol_quantity = orders_buf[i].o_ol[j].ol_quantity;
            ol_amount  = orders_buf[i].o_ol[j].ol_amount;

            strcpy(ol_delivery_d,orders_buf[i].o_ol[j].ol_delivery_d);

            strcpy(ol_dist_info,orders_buf[i].o_ol[j].ol_dist_info);

            rc = bcp_sendrow(o_hdbc3);
            if (rc != SUCCEEDED)
                HandleErrorDBC(o_hdbc3);

            order_line_rows_loaded++;
            CheckForCommit(o_hdbc3, o_hstmt3, order_line_rows_loaded,
"order_line", &order_line_time_start->time_start);
        }

        // rcint = bcp_batch(o_hdbc3);
        // if (rcint < 0)
        //     HandleErrorDBC(o_hdbc3);

        if ((o_w_id == aptr->num_warehouses) && (o_d_id == 10))
        {
            rcint = bcp_done(o_hdbc3);
            if (rcint < 0)
                HandleErrorDBC(o_hdbc3);

            SQLFreeStmt(o_hstmt3, SQL_DROP);
            SQLDisconnect(o_hdbc3);
            SQLFreeConnect(o_hdbc3);

            // if build index after load...
            if ((aptr->build_index == 1) && (aptr->index_order == 0))
                BuildIndex("idxodlcl");
        }
    }

    //=====
    //
    // Function   : GetPermutation
    //
    //=====
void GetPermutation(int perm[], int n)
{
    int i, r, t;
```

Appendix B - Database Design

```
for (i=1;i<=n;i++)
    perm[i] = i;

for (i=1;i<=n;i++)
{
    r = RandomNumber(i,n);
    t = perm[i];
    perm[i] = perm[r];
    perm[r] = t;
}

//=====
//
// Function   : CheckForCommit
//
//=====

void CheckForCommit(HDBC hdbc,
                   HSTMT hstmt,
                   int rows_loaded,
                   char *table_name,
                   long *time_start)
{
    long time_end, time_diff;
    // DBINT rcint;

    if ( !(rows_loaded % aptr->batch) )
    {
        // rcint = bcp_batch(hdbc);
        // if (rcint < 0)
        //     HandleErrorDBC(hdbc);

        time_end = (TimeNow() / MILLI);
        time_diff = time_end - *time_start;

        printf("-> Loaded %ld rows into %s in %ld sec - Total = %d (%.2f
rps)\n",
               aptr->batch,
               table_name,
               time_diff,
               rows_loaded,
               (float) aptr->batch / (time_diff ? time_diff :
1L));

        *time_start = time_end;
    }

    return;
}

//=====
//
// Function   : OpenConnections
//
//=====
```

```
void OpenConnections()
{
    RETCODE          rc;

    char              szDriverString[300];
    char              szDriverStringOut[1024];
    SQLSMALLINT       cbDriverStringOut;

    SQLAllocHandle(SQL_HANDLE_ENV, SQL_NULL_HANDLE, &henv );

    SQLSetEnvAttr(henv, SQL_ATTR_ODBC_VERSION, (void*)SQL_OV_ODBC3, 0 );

    SQLAllocHandle(SQL_HANDLE_DBC, henv , &i_hdbc1);
    SQLAllocHandle(SQL_HANDLE_DBC, henv , &w_hdbc1);
    SQLAllocHandle(SQL_HANDLE_DBC, henv , &c_hdbc1);
    SQLAllocHandle(SQL_HANDLE_DBC, henv , &c_hdbc2);
    SQLAllocHandle(SQL_HANDLE_DBC, henv , &o_hdbc1);
    SQLAllocHandle(SQL_HANDLE_DBC, henv , &o_hdbc2);
    SQLAllocHandle(SQL_HANDLE_DBC, henv , &o_hdbc3);

    SQLSetConnectAttr(i_hdbc1, SQL_COPT_SS_BCP, (void *)SQL_BCP_ON, SQL_IS_INTEGER
);
    SQLSetConnectAttr(w_hdbc1, SQL_COPT_SS_BCP, (void *)SQL_BCP_ON, SQL_IS_INTEGER
);
    SQLSetConnectAttr(c_hdbc1, SQL_COPT_SS_BCP, (void *)SQL_BCP_ON, SQL_IS_INTEGER
);
    SQLSetConnectAttr(c_hdbc2, SQL_COPT_SS_BCP, (void *)SQL_BCP_ON, SQL_IS_INTEGER
);
    SQLSetConnectAttr(o_hdbc1, SQL_COPT_SS_BCP, (void *)SQL_BCP_ON, SQL_IS_INTEGER
);
    SQLSetConnectAttr(o_hdbc2, SQL_COPT_SS_BCP, (void *)SQL_BCP_ON, SQL_IS_INTEGER
);
    SQLSetConnectAttr(o_hdbc3, SQL_COPT_SS_BCP, (void *)SQL_BCP_ON, SQL_IS_INTEGER
);

    // Open connections to SQL Server
    // Connection 1

    sprintf( szDriverString , "DRIVER={SQL
Server};SERVER=%s;UID=%s;PWD=%s;DATABASE=%s" ,
            aptr->server,
            aptr->user,
            aptr->password,
            aptr->database );

    rc = SQLSetConnectOption (i_hdbc1, SQL_PACKET_SIZE, aptr->pack_size);
    if (rc != SUCCEED)
        HandleErrorDBC(i_hdbc1);

    rc = SQLDriverConnect ( i_hdbc1,
                            NULL,
                            (SQLCHAR*)&szDriverString[0],
                            SQL_NTS,
                            (SQLCHAR*)&szDriverStringOut[0],
                            sizeof(szDriverStringOut),
                            &cbDriverStringOut,
                            SQL_DRIVER_NOPROMPT );

    if (rc != SUCCEED)
```

Appendix B - Database Design

```
        HandleErrorDBC(i_hdbc1);
// Connection 2
    sprintf( szDriverString , "DRIVER={SQL
Server};SERVER=%s;UID=%s;PWD=%s;DATABASE=%s" ,
        aptr->server,
        aptr->user,
        aptr->password,
        aptr->database );

    rc = SQLSetConnectOption (w_hdbc1, SQL_PACKET_SIZE, aptr->pack_size);
    if (rc != SUCCEEDED)
        HandleErrorDBC(w_hdbc1);

    rc = SQLDriverConnect ( w_hdbc1,
        NULL,
        (SQLCHAR*)&szDriverString[0] ,
        SQL_NTS,
        (SQLCHAR*)&szDriverStringOut[0],
        sizeof(szDriverStringOut),
        &cbDriverStringOut,
        SQL_DRIVER_NOPROMPT
    );
    if (rc != SUCCEEDED)
        HandleErrorDBC(w_hdbc1);
// Connection 3
    sprintf( szDriverString , "DRIVER={SQL
Server};SERVER=%s;UID=%s;PWD=%s;DATABASE=%s" ,
        aptr->server,
        aptr->user,
        aptr->password,
        aptr->database );

    rc = SQLSetConnectOption (c_hdbc1, SQL_PACKET_SIZE, aptr->pack_size);
    if (rc != SUCCEEDED)
        HandleErrorDBC(c_hdbc1);

    rc = SQLDriverConnect ( c_hdbc1,
        NULL,
        (SQLCHAR*)&szDriverString[0] ,
        SQL_NTS,
        (SQLCHAR*)&szDriverStringOut[0],
        sizeof(szDriverStringOut),
        &cbDriverStringOut,
        SQL_DRIVER_NOPROMPT
    );
    if (rc != SUCCEEDED)
        HandleErrorDBC(c_hdbc1);
// Connection 4
    sprintf( szDriverString , "DRIVER={SQL
Server};SERVER=%s;UID=%s;PWD=%s;DATABASE=%s" ,
        aptr->server,
        aptr->user,
        aptr->password,
        aptr->database );

    rc = SQLSetConnectOption (c_hdbc2, SQL_PACKET_SIZE, aptr->pack_size);
    if (rc != SUCCEEDED)
        HandleErrorDBC(c_hdbc2);

    rc = SQLDriverConnect ( c_hdbc2,
        NULL,
        (SQLCHAR*)&szDriverString[0] ,
        SQL_NTS,
        (SQLCHAR*)&szDriverStringOut[0],
        sizeof(szDriverStringOut),
        &cbDriverStringOut,
        SQL_DRIVER_NOPROMPT
    );
    if (rc != SUCCEEDED)
        HandleErrorDBC(c_hdbc2);
// Connection 5
    sprintf( szDriverString , "DRIVER={SQL
Server};SERVER=%s;UID=%s;PWD=%s;DATABASE=%s" ,
        aptr->server,
        aptr->user,
        aptr->password,
        aptr->database );

    rc = SQLSetConnectOption (o_hdbc1, SQL_PACKET_SIZE, aptr->pack_size);
    if (rc != SUCCEEDED)
        HandleErrorDBC(o_hdbc1);

    rc = SQLDriverConnect ( o_hdbc1,
        NULL,
        (SQLCHAR*)&szDriverString[0] ,
        SQL_NTS,
        (SQLCHAR*)&szDriverStringOut[0],
        sizeof(szDriverStringOut),
        &cbDriverStringOut,
        SQL_DRIVER_NOPROMPT
    );
    if (rc != SUCCEEDED)
        HandleErrorDBC(o_hdbc1);
// Connection 6
    sprintf( szDriverString , "DRIVER={SQL
Server};SERVER=%s;UID=%s;PWD=%s;DATABASE=%s" ,
        aptr->server,
        aptr->user,
        aptr->password,
        aptr->database );

    rc = SQLSetConnectOption (o_hdbc2, SQL_PACKET_SIZE, aptr->pack_size);
    if (rc != SUCCEEDED)
        HandleErrorDBC(o_hdbc2);
```

Appendix B - Database Design

```
rc = SQLDriverConnect ( o_hdbc2,
                        NULL,
                        (SQLCHAR*)&szDriverString[0] ,
                        SQL_NTS,
                        (SQLCHAR*)&szDriverStringOut[0],
                        sizeof(szDriverStringOut),
                        &cbDriverStringOut,
                        SQL_DRIVER_NOPROMPT
);
if (rc != SUCCEED)
    HandleErrorDBC(o_hdbc2);
// Connection 7
sprintf( szDriverString , "DRIVER={SQL
Server};SERVER=%s;UID=%s;PWD=%s;DATABASE=%s" ,
        aptr->server,
        aptr->user,
        aptr->password,
        aptr->database );
rc = SQLSetConnectOption (o_hdbc3, SQL_PACKET_SIZE, aptr->pack_size);
if (rc != SUCCEED)
    HandleErrorDBC(o_hdbc3);
rc = SQLDriverConnect ( o_hdbc3,
                        NULL,
                        (SQLCHAR*)&szDriverString[0] ,
                        SQL_NTS,
                        (SQLCHAR*)&szDriverStringOut[0],
                        sizeof(szDriverStringOut),
                        &cbDriverStringOut,
                        SQL_DRIVER_NOPROMPT
);
if (rc != SUCCEED)
    HandleErrorDBC(o_hdbc3);
}
//=====
//
// Function name: BuildIndex
//
//=====
void BuildIndex(char      *index_script)
{
    char    cmd[256];
    printf("Starting index creation: %s\n",index_script);
    sprintf(cmd, "isql -S%s -U%s -P%s -e -i%s\\%s.sql > logs\\%s.log",
            aptr->server,
            aptr->user,
            aptr->password,
            aptr->index_script_path,
```

```
        index_script,
        index_script);
    system(cmd);
    printf("Finished index creation: %s\n",index_script);
}
void HandleErrorDBC (SQLHDBC hdbc1)
{
    SQLCHAR      SqlState[6], Msg[SQL_MAX_MESSAGE_LENGTH];
    SQLINTEGER   NativeError;
    SQLSMALLINT i, MsgLen;
    SQLRETURN    rc2;
    char         timebuf[128];
    char         datebuf[128];
    FILE         *fp1;
    i = 1;
    while (( rc2 = SQLGetDiagRec(SQL_HANDLE_DBC , hdbc1, i, SqlState ,
    &NativeError,
                                Msg, sizeof(Msg) , &MsgLen )) != SQL_NO_DATA )
    {
        sprintf( szLastError , "%s" , Msg );
        _strtime(timebuf);
        _strdate(datebuf);
        printf( "[%s : %s] %s\n" , datebuf, timebuf, szLastError);
        fp1 = fopen("logs\\tpccldr.err","w");
        if (fp1 == NULL)
            printf("ERROR: Unable to open errorlog file.\n");
        else
        {
            fprintf(fp1, "[%s : %s] %s\n" , datebuf, timebuf,
            szLastError);
            fclose(fp1);
        }
        i++;
    }
}
void FormatDate ( char* szTimeCOutput )
{
    struct tm when;
    time_t now;
    time( &now );
    when = *localtime( &now );
    mktime( &when );
    // odbc datetime format
    strftime( szTimeCOutput , 30 , "%Y-%m-%d %H:%M:%S.000", &when );
```

Appendix B - Database Design

```
        return;
    }
}
```

getargs.c

```
//      File:          GETARGS.C
//
//      Microsoft TPC-C Kit Ver. 4.00
//      Copyright Microsoft, 1996, 1997, 1998
//      Purpose: Source file for command line processing

// Includes
#include "tpcc.h"

//=====
//
// Function name: GetArgsLoader
//
//=====

void GetArgsLoader(int argc, char **argv, TPCCLDR_ARGS *pargs)
{
    int     i;
    char *ptr;

#ifdef DEBUG
    printf("[%ld]DBG: Entering GetArgsLoader()\n", (int) GetCurrentThreadId());
#endif

    /* init args struct with some useful values */
    pargs->server      = SERVER;
    pargs->user         = USER;
    pargs->password     = PASSWORD;
    pargs->database     = DATABASE;
    pargs->batch        = BATCH;
    pargs->num_warehouses = UNDEF;
    pargs->tables_all   = TRUE;
    pargs->table_item    = FALSE;
    pargs->table_warehouse = FALSE;
    pargs->table_customer = FALSE;
}
```

```
pargs->table_orders      = FALSE;
pargs->loader_res_file   = LOADER_RES_FILE;
pargs->pack_size         = DEFLDPACKSIZE;
pargs->starting_warehouse = DEF_STARTING_WAREHOUSE;
pargs->build_index       = BUILD_INDEX;
pargs->index_order        = INDEX_ORDER;
pargs->index_script_path  = INDEX_SCRIPT_PATH;
pargs->scale_down        = SCALE_DOWN;

/* check for zero command line args */
if ( argc == 1 )
    GetArgsLoaderUsage();

for ( i = 1; i < argc; ++i)
{
    if (argv[i][0] != '-' && argv[i][0] != '/')
    {
        printf("\nUnrecognized command");
        GetArgsLoaderUsage();
        exit(1);
    }

    ptr = argv[i];

    switch (ptr[1])
    {
        case 'h': /* Fall through */
        case 'H':
            GetArgsLoaderUsage();
            break;

        case 'D':
            pargs->database = ptr+2;
            break;

        case 'P':
            pargs->password = ptr+2;
            break;

        case 'S':
            pargs->server = ptr+2;
            break;

        case 'U':
            pargs->user = ptr+2;
            break;

        case 'b':
            pargs->batch = atol(ptr+2);
            break;

        case 'W':
            pargs->num_warehouses = atol(ptr+2);
            break;

        case 's':
            pargs->starting_warehouse = atol(ptr+2);
            break;

        case 't':
            {
                pargs->tables_all = FALSE;
                if (strcmp(ptr+2,"item") == 0)
            }
    }
}
```

Appendix B - Database Design

```
0)
TRUE;

        pargs->table_item = TRUE;
    else if (strcmp(ptr+2,"warehouse") ==
        pargs->table_warehouse =
    else if (strcmp(ptr+2,"customer") == 0)
        pargs->table_customer = TRUE;
    else if (strcmp(ptr+2,"orders") == 0)
        pargs->table_orders = TRUE;
    else
    {
        printf("\nUnrecognized command");
        GetArgsLoaderUsage();
        exit(1);
    }
    break;

case 'f':
    pargs->loader_res_file = ptr+2;
    break;

case 'p':
    pargs->pack_size = atol(ptr+2);
    break;

case 'i':
    pargs->build_index = atol(ptr+2);
    break;

case 'o':
    pargs->index_order = atol(ptr+2);
    break;

case 'c':
    pargs->scale_down = atol(ptr+2);
    break;

case 'd':
    pargs->index_script_path = ptr+2;
    break;

default:
    GetArgsLoaderUsage();
    exit(-1);
    break;
}

}

/* check for required args */
if (pargs->num_warehouses == UNDEF )
{
    printf("Number of Warehouses is required\n");
    exit(-2);
}

return;
}

//=====
//
```

```
// Function name: GetArgsLoaderUsage
//
//=====

void GetArgsLoaderUsage()
{
#ifdef DEBUG
    printf("[%ld]DBG: Entering GetArgsLoaderUsage()\n", (int) GetCurrentThreadId());
#endif

    printf("TPCCLDR:\n\n");
    printf("Parameter                                     Default\n");
    printf("-----\n");
    printf("-W Number of Warehouses to Load                Required \n");
    printf("-S Server                                         %s\n", SERVER);
    printf("-U Username                                       %s\n", USER);
    printf("-P Password                                       %s\n", PASSWORD);
    printf("-D Database                                       %s\n", DATABASE);
    printf("-b Batch Size                                     %ld\n", (long)
BATCH);
    printf("-p TDS packet size                               %ld\n", (long)
DEFLDPACKSIZE);
    printf("-f Loader Results Output Filename              %s\n",
LOADER_RES_FILE);
    printf("-s Starting Warehouse                          %ld\n", (long)
DEF_STARTING_WAREHOUSE);
    printf("-i Build Option (data = 0, data and index = 1)  %ld\n", (long)
BUILD_INDEX);
    printf("-o Cluster Index Build Order (before = 1, after = 0) %ld\n", (long)
INDEX_ORDER);
    printf("-c Build Scaled Database (normal = 0, tiny = 1) %ld\n", (long)
SCALE_DOWN);
    printf("-d Index Script Path                             %s\n",
INDEX_SCRIPT_PATH);
    printf("-t Table to Load                                 all tables \n");
    printf("    [item|warehouse|customer|orders]\n");
    printf("    Notes: \n");
    printf("    - the '-t' parameter may be included multiple times to \n");
    printf("    specify multiple tables to be loaded \n");
    printf("    - 'item' loads ITEM table \n");
    printf("    - 'warehouse' loads WAREHOUSE, DISTRICT, and STOCK tables \n");
    printf("    - 'customer' loads CUSTOMER and HISTORY tables \n");
    printf("    - 'orders' load NEW-ORDER, ORDERS, ORDER-LINE tables \n");

    printf("\nNote: Command line switches are case sensitive.\n");

    exit(0);
}

}

random.c

//      File:                RANDOM.C
//
//      Microsoft TPC-C Kit Ver. 4.00
//      Copyright Microsoft, 1996, 1997, 1998
```

Appendix B - Database Design

```
// Purpose: Random number generation routines for database loader

// Includes
#include "tpcc.h"
#include "math.h"

// Defines
#define A 16807
#define M 2147483647
#define Q 127773 /* M div A */
#define R 2836 /* M mod A */
#define Thread __declspec(thread)

// Globals
long Thread Seed = 0; /* thread local seed */

/*****
 *
 * random -
 * Implements a GOOD pseudo random number generator. This generator
 * will/should? run the complete period before repeating.
 *
 * Copied from:
 * Random Numbers Generators: Good Ones Are Hard to Find.
 * Communications of the ACM - October 1988 Volume 31 Number 10
 *
 * Machine Dependencies:
 * long must be 2 ^ 31 - 1 or greater.
 *****/

/*****
 * seed - load the Seed value used in irand and drand. Should be used before
 * first call to irand or drand.
 *****/

void seed(long val)
{
#ifdef DEBUG
    printf("[%ld]DBG: Entering seed()...\n", (int) GetCurrentThreadId());
    printf("Old Seed %ld New Seed %ld\n",Seed, val);
#endif

    if ( val < 0 )
        val = abs(val);

    Seed = val;
}

/*****
 *
 * irand - returns a 32 bit integer pseudo random number with a period of
 * 1 to 2 ^ 32 - 1.
 *
 * parameters:
 * none.
 *
 * returns:
 * 32 bit integer - defined as long ( see above ).
 *****/
```

```
*
 * side effects:
 * seed get recomputed.
 *****/

long irand()
{
    register long s; /* copy of seed */
    register long test; /* test flag */
    register long hi; /* tmp value for speed */
    register long lo; /* tmp value for speed */

#ifdef DEBUG
    printf("[%ld]DBG: Entering irand()...\n", (int) GetCurrentThreadId());
#endif

    s = Seed;
    hi = s / Q;
    lo = s % Q;

    test = A * lo - R * hi;
    if ( test > 0 )
        Seed = test;
    else
        Seed = test + M;

    return( Seed );
}

/*****
 *
 * drand - returns a double pseudo random number between 0.0 and 1.0.
 * See irand.
 *****/

double drand()
{
#ifdef DEBUG
    printf("[%ld]DBG: Entering drand()...\n", (int) GetCurrentThreadId());
#endif

    return( (double)irand() / 2147483647.0);
}

//=====
// Function : RandomNumber
//
// Description:
//=====
long RandomNumber(long lower, long upper)
{
    long rand_num;

#ifdef DEBUG
    printf("[%ld]DBG: Entering RandomNumber()...\n", (int) GetCurrentThreadId());
#endif

    if ( upper == lower ) /* pgd 08-13-96 perf enhancement */
        return lower;

    upper++;
```

Appendix B - Database Design

```
    if ( upper <= lower )
        rand_num = upper;
    else
        rand_num = lower + irand() % (upper - lower); /* pgd 08-13-96 perf
enhancement */

#ifdef DEBUG
    printf("[%ld]DBG: RandomNumber between %ld & %ld ==> %ld\n",
           (int) GetCurrentThreadId(), lower, upper,
           rand_num);
#endif

    return rand_num;
}

#if 0
//Original code pgd 08/13/96
long RandomNumber(long lower,
                  long upper)
{
    long rand_num;

#ifdef DEBUG
    printf("[%ld]DBG: Entering RandomNumber()...\n", (int) GetCurrentThreadId());
#endif

    upper++;

    if ((upper <= lower))
        rand_num = upper;
    else
        rand_num = lower + irand() % ((upper > lower) ? upper - lower :
upper);

#ifdef DEBUG
    printf("[%ld]DBG: RandomNumber between %ld & %ld ==> %ld\n",
           (int) GetCurrentThreadId(), lower, upper,
           rand_num);
#endif

    return rand_num;
}
#endif

//=====
// Function : NURand
//
// Description:
//=====
long NURand(int iConst,
            long x,
            long y,
            long C)
{
    long rand_num;
```

```
#ifdef DEBUG
    printf("[%ld]DBG: Entering NURand()...\n", (int) GetCurrentThreadId());
#endif

    rand_num = (((RandomNumber(0,iConst) | RandomNumber(x,y)) + C) % (y-x+1))+x;

#ifdef DEBUG
    printf("[%ld]DBG: NURand: num = %d\n", (int) GetCurrentThreadId(), rand_num);
#endif

    return rand_num;
}
```

strings.c

```
//      File:          STRINGS.C
//                               Microsoft TPC-C Kit Ver. 4.00
//                               Copyright Microsoft, 1996, 1997, 1998
//      Purpose: Source file for database loader string functions

// Includes
#include "tpcc.h"
#include <string.h>
#include <ctype.h>

//=====
//
// Function name: MakeAddress
//
//=====

void MakeAddress(char *street_1,
                char *street_2,
                char *city,
                char *state,
                char *zip)
{
#ifdef DEBUG
    printf("[%ld]DBG: Entering MakeAddress()\n", (int) GetCurrentThreadId());
#endif

    MakeAlphaString (10, 20, ADDRESS_LEN, street_1);
    MakeAlphaString (10, 20, ADDRESS_LEN, street_2);
    MakeAlphaString (10, 20, ADDRESS_LEN, city);
    MakeAlphaString ( 2,  2, STATE_LEN, state);
    MakeZipNumberString( 9,  9, ZIP_LEN, zip);

#ifdef DEBUG
    printf("[%ld]DBG: MakeAddress: street_1: %s, street_2: %s, city: %s, state: %s, zip:
%s\n",
           (int) GetCurrentThreadId(), street_1, street_2, city,
           state, zip);
#endif
}
```

Appendix B - Database Design

```
return;
}

//=====
//
// Function name: LastName
//
//=====

void LastName(int num,
              char *name)
{
    static char *n[] =
    {
        "BAR" , "OUGHT" , "ABLE" , "PRI" , "PRES" ,
        "ESE" , "ANTI" , "CALLY" , "ATION" , "EING"
    };

#ifdef DEBUG
    printf("[%ld]DBG: Entering LastName()\n", (int) GetCurrentThreadId());
#endif

    if ((num >= 0) && (num < 1000))
    {
        strcpy(name, n[(num/100)%10]);
        strcat(name, n[(num/10)%10]);
        strcat(name, n[(num/1)%10]);

        if (strlen(name) < LAST_NAME_LEN)
        {
            PaddString(LAST_NAME_LEN, name);
        }
    }
    else
    {
        printf("\nError in LastName()... num < %ld> out of range (0,999)\n",
num);
        exit(-1);
    }

#ifdef DEBUG
    printf("[%ld]DBG: LastName: num = [%d] ==> [%d][%d][%d]\n",
(int) GetCurrentThreadId(), num, num/100, (num/10)%10,
num%10);
    printf("[%ld]DBG: LastName: String = %s\n", (int) GetCurrentThreadId(), name);
#endif

    return;
}

//=====
//
// Function name: MakeAlphaString
//
//=====
```

```
//philipdu 08/13/96 Changed MakeAlphaString to use A-Z, a-z, and 0-9 in
//accordance with spec see below:
//The spec says:
//4.3.2.2 The notation random a-string [x .. y]
//(respectively, n-string [x .. y]) represents a string of random alphanumeric
//(respectively, numeric) characters of a random length of minimum x, maximum y,
//and mean (y+x)/2. Alphanumerics are A..Z, a..z, and 0..9. The only other
//requirement is that the character set used "must be able to represent a minimum
//of 128 different characters". We are using 8-bit chars, so this is a non issue.
//It is completely unreasonable to stuff non-printing chars into the text fields.
//-CLevine 08/13/96

int MakeAlphaString( int x, int y, int z, char *str)
{
    int len;
    int i;
    static char chArray[] =
"0123456789ABCDEFGHIJKLMNOPQRSTUVWXYZabcdefghijklmnopqrstuvwxyz";
    static int chArrayMax = 61;

#ifdef DEBUG
    printf("[%ld]DBG: Entering MakeAlphaString()\n", (int) GetCurrentThreadId());
#endif

    len= RandomNumber(x, y);

    for (i=0; i<len; i++)
        str[i] = chArray[RandomNumber(0, chArrayMax)];
    if ( len < z )
        memset(str+len, ' ', z - len);
    str[len] = 0;

    return len;
}

//=====
//
// Function name: MakeOriginalAlphaString
//
//=====

int MakeOriginalAlphaString(int x,
                            int y,
                            int z,
                            char *str,
                            int percent)
{
    int len;
    int val;
    int start;

#ifdef DEBUG
    printf("[%ld]DBG: Entering MakeOriginalAlphaString()\n", (int) GetCurrentThreadId());
#endif

    // verify percentage is valid
    if ((percent < 0) || (percent > 100))
    {
        printf("MakeOriginalAlphaString: Invalid percentage: %d\n", percent);
        exit(-1);
    }
}
```

Appendix B - Database Design

```
// verify string is at least 8 chars in length
if ((x + y) <= 8)
{
    printf("MakeOriginalAlphaString: string length must be >= 8\n");
    exit(-1);
}

// Make Alpha String
len = MakeAlphaString(x,y, z, str);

val = RandomNumber(1,100);
if (val <= percent)
{
    start = RandomNumber(0, len - 8);
    strncpy(str + start, "ORIGINAL", 8);
}

#ifdef DEBUG
printf("[%ld]DBG: MakeOriginalAlphaString: : %s\n",
      (int) GetCurrentThreadId(), str);
#endif

return strlen(str);
}

//=====
//
// Function name: MakeNumberString
//
//=====
int MakeNumberString(int x, int y, int z, char *str)
{
    char tmp[16];

    //MakeNumberString is always called MakeZipNumberString(16, 16, 16, string)

    memset(str, '0', 16);
    itoa(RandomNumber(0, 99999999), tmp, 10);
    memcpy(str, tmp, strlen(tmp));

    itoa(RandomNumber(0, 99999999), tmp, 10);
    memcpy(str+8, tmp, strlen(tmp));

    str[16] = 0;

    return 16;
}

//=====
//
// Function name: MakeZipNumberString
//
//=====
int MakeZipNumberString(int x, int y, int z, char *str)
{
    char tmp[16];

    //MakeZipNumberString is always called MakeZipNumberString(9, 9, 9, string)

    strcpy(str, "000011111");
}
```

```
    itoa(RandomNumber(0, 9999), tmp, 10);
    memcpy(str, tmp, strlen(tmp));

    return 9;
}

//=====
//
// Function name: InitString
//
//=====
void InitString(char *str, int len)
{
#ifdef DEBUG
    printf("[%ld]DBG: Entering InitString()\n", (int) GetCurrentThreadId());
#endif

    memset(str, ' ', len);
    str[len] = 0;
}

//=====
//
// Function name: InitAddress
//
// Description:
//
//=====
void InitAddress(char *street_1, char *street_2, char *city, char *state, char *zip)
{
    memset(street_1, ' ', ADDRESS_LEN+1);
    memset(street_2, ' ', ADDRESS_LEN+1);
    memset(city, ' ', ADDRESS_LEN+1);

    street_1[ADDRESS_LEN+1] = 0;
    street_2[ADDRESS_LEN+1] = 0;
    city[ADDRESS_LEN+1] = 0;

    memset(state, ' ', STATE_LEN+1);
    state[STATE_LEN+1] = 0;

    memset(zip, ' ', ZIP_LEN+1);
    zip[ZIP_LEN+1] = 0;
}

//=====
//
// Function name: PaddString
//
//=====
void PaddString(int max, char *name)
{
    int len;

    len = strlen(name);
    if ( len < max )
        memset(name+len, ' ', max - len);
    name[max] = 0;
}
```

Appendix B - Database Design

```
        return;  
    }
```

time.c

```
//      File:          TIME.C  
//      Microsoft TPC-C Kit Ver. 4.00  
//      Copyright Microsoft, 1996, 1997, 1998  
//      Purpose: Source file for time functions  
  
// Includes  
#include "tpcc.h"  
  
// Globals  
static long start_sec;  
  
//=====  
//  
// Function name: TimeNow  
//  
//=====  
  
long TimeNow()  
{  
    long      time_now;  
    struct _timeb el_time;  
  
#ifdef DEBUG  
    printf("[%ld]DBG: Entering TimeNow()\n", (int) GetCurrentThreadId());  
#endif  
  
    _ftime(&el_time);  
  
    time_now = ((el_time.time - start_sec) * 1000) + el_time.millitm;  
  
    return time_now;  
}
```

Appendix C – Tunable Parameters

Appendix C - Tunable Parameters

Server Configuration Parameters

Microsoft Windows 2000 Server Parameters

The following registry key was added to disable the kernel counters for Global and Per-Process I/Os:

```
[HKEY_LOCAL_MACHINE\SYSTEM\CurrentControlSet\Control\Session Manager\I/O System]
"CountOperations"=dword:00000000
```

Microsoft Windows 2000 Server Configuration

The following services were disabled on the server:

- Alerter
- Computer Browser
- DHCP Client
- Distributed File System
- Distributed Link Tracking Client
- DNS Client
- Global Array Manager Server
- IPSEC Policy Agent
- License Logging Service
- Messenger
- Microsoft Search
- Print Spooler
- Process Control Service
- Remote Registry Service
- Removable Storage
- Run as Service
- System Event Notification
- Task Scheduler

Microsoft SQL Server 2000 Startup Parameters

Microsoft SQL Server was started with the following command line options

sqlservr -c -x -T3502 -g100

where

- | | |
|--------|---|
| -c | Start SQL Server independently of the Microsoft Windows NT Service Control Manager. |
| -x | Disable the keeping of CPU time and cache-hit ratio statistics. |
| -T3502 | Prints a message to the log at the beginning and end of each checkpoint. |
| -g100 | Reserve 100 MB for non-buffer pool allocations |

Appendix C – Tunable Parameters

Microsoft SQL Server Stack Size

The default stack size of Microsoft SQL Server was changed using the EDITBIN utility. The EDITBIN utility ships with Microsoft Visual C++ V5.0. The command used was editbin /stack:131072 sqlservr.exe.

Mylex Device Drivers and Firmware

The following device drivers were added:

- Mylex BIOS: 6:01-00
- Mylex Firmware: 6.00-13
- Miniport driver : 6.00-03 (dac2w2k.sys)
- Accelerated Driver : 5.50-20 (macdw2k.sys)

Mylex Registry Key

```
[HKEY_LOCAL_MACHINE\SYSTEM\CurrentControlSet\Services\dac2w2k\Parameters\Device]
"DriverParameter"="ConfigureSIR=16"
```

Microsoft SQL Server 2000 Configuration Parameters

name	minimum	maximum	config_value	run_value
affinity mask	0	2147483647	1	1
allow updates	0	1	1	1
c2 audit mode	0	1	0	0
cost threshold for parallelism	0	32767	5	5
cursor threshold	-1	2147483647	-1	-1
default full-text language	0	2147483647	1033	1033
default language	0	9999	0	0
fill factor (%)	0	100	0	0
index create memory (KB)	704	1600000	0	0
language in cache	3	100	3	3
lightweight pooling	0	1	1	1
locks	5000	2147483647	0	0
max degree of parallelism	0	32	1	1
max server memory (MB)	4	2147483647	2000	2000
max text repl size (B)	0	2147483647	65536	65536
max worker threads	10	1024	168	168
media retention	0	365	0	0
min memory per query (KB)	512	2147483647	1024	1024
min server memory (MB)	0	2147483647	100	100
nested triggers	0	1	1	1
network packet size (B)	512	65535	4096	4096
open objects	0	2147483647	0	0
priority boost	0	1	1	1
query governor cost limit	0	2147483647	0	0
query wait (s)	-1	2147483647	-1	-1
recovery interval (min)	0	32767	32767	32767
remote access	0	1	0	0
remote login timeout (s)	0	2147483647	5	5
remote proc trans	0	1	0	0
remote query timeout (s)	0	2147483647	0	0
scan for startup procs	0	1	0	0
set working set size	0	1	0	0
show advanced options	0	1	1	1
two digit year cutoff	1753	9999	2049	2049
user connections	0	32767	0	0
user options	0	16383	0	0

Appendix C – Tunable Parameters

Windows 2000 Server System Information Report For PE2500

System Information report written at: 11/30/2001 03:03:42 PM
[System Information]

[Following are sub-categories of this main category]

[System Summary]

Item	Value
OS Name	Microsoft Windows 2000 Server
Version	5.0.2195 Build 2195
OS Manufacturer	Microsoft Corporation
System Name	PE2500
System Manufacturer	Dell Computer Corporation
System Model	PowerEdge 2500
System Type	X86-based PC
Processor	x86 Family 6 Model 11 Stepping 1 GenuineIntel ~1130 Mhz
BIOS Version	Phoenix ROM BIOS PLUS Version 1.10 A04
Windows Directory	C:\WINNT
System Directory	C:\WINNT\System32
Boot Device	\Device\Harddisk0\Partition1
Locale	United States
User Name	PE2500\Administrator
Time Zone	Central Standard Time
Total Physical Memory	2,358,772 KB
Available Physical Memory	961,048 KB
Total Virtual Memory	6,654,508 KB
Available Virtual Memory	3,981,688 KB
Page File Space	4,295,736 KB
Page File	C:\pagefile.sys

[Hardware Resources]

[Following are sub-categories of this main category]

[Conflicts/Sharing]

Resource	Device
IRQ 15	System board
IRQ 15	Secondary IDE Channel

[DMA]

Channel	Device	Status
4	Direct memory access controller	OK
2	Standard floppy disk controller	OK

[Forced Hardware]

Device PNP Device ID
~~No Forced Hardware~~

Appendix C – Tunable Parameters

[I/O]

Address Range	Device	Status
0x0000-0x03AF	PCI bus	OK
0x0000-0x03AF	Direct memory access controller	OK
0x03B0-0x03DF	PCI bus	OK
0x03B0-0x03DF	ATI Technologies Inc. RAGE XL PCI	OK
0x03E0-0x0FFF	PCI bus	OK
0xE000-0xEFFF	PCI bus	OK
0xECA0-0xECBF	Intel(R) PRO/100+ PCI Adapter	OK
0xE800-0xE8FF	ATI Technologies Inc. RAGE XL PCI	OK
0x03C0-0x03DF	ATI Technologies Inc. RAGE XL PCI	OK
0x0A79-0x0A79	ISAPNP Read Data Port	OK
0x0279-0x0279	ISAPNP Read Data Port	OK
0x02F4-0x02F7	ISAPNP Read Data Port	OK
0x0080-0x009F	Direct memory access controller	OK
0x00C0-0x00DF	Direct memory access controller	OK
0x00F0-0x00FF	Numeric data processor	OK
0x0020-0x003F	Programmable interrupt controller	OK
0x00A0-0x00BF	Programmable interrupt controller	OK
0x04D0-0x04D1	Programmable interrupt controller	OK
0x0061-0x0061	System speaker	OK
0x0040-0x005F	System timer	OK
0x03F0-0x03F5	Standard floppy disk controller	OK
0x03F7-0x03F7	Standard floppy disk controller	OK
0x0060-0x0060	Standard 101/102-Key or Microsoft Natural PS/2 Keyboard	OK
0x0064-0x0064	Standard 101/102-Key or Microsoft Natural PS/2 Keyboard	OK
0x03F8-0x03FF	Communications Port (COM1)	OK
0x02F8-0x02FF	Communications Port (COM2)	OK
0x0378-0x037F	ECP Printer Port (LPT1)	OK
0x0778-0x077F	ECP Printer Port (LPT1)	OK
0x0070-0x007F	System CMOS/real time clock	OK
0x0814-0x085B	System board	OK
0x08A0-0x08AF	System board	OK
0x0C00-0x0CD7	System board	OK
0x0F50-0x0F58	System board	OK
0x00E0-0x00EF	System board	OK
0x08B0-0x08BF	Standard Dual Channel PCI IDE Controller	OK
0x01F0-0x01F7	Primary IDE Channel	OK
0x03F6-0x03F6	Primary IDE Channel	OK
0x0170-0x0177	Secondary IDE Channel	OK
0x0376-0x0376	Secondary IDE Channel	OK
0xD000-0xDFFF	PCI bus	OK
0xD000-0xDFFF	PCI standard PCI-to-PCI bridge	OK
0xDC00-0xDCFF	Adaptec AIC-7899 Ultra160/m PCI SCSI Card	OK
0xD800-0xD8FF	Adaptec AIC-7899 Ultra160/m PCI SCSI Card	OK

[IRQs]

IRQ Number	Device
9	Microsoft ACPI-Compliant System
29	Intel(R) PRO/100+ PCI Adapter
13	Numeric data processor
6	Standard floppy disk controller

Appendix C – Tunable Parameters

1	Standard 101/102-Key or Microsoft Natural PS/2 Keyboard
12	PS/2 Compatible Mouse
4	Communications Port (COM1)
3	Communications Port (COM2)
8	System CMOS/real time clock
15	System board
15	Secondary IDE Channel
14	Primary IDE Channel
26	Adaptec AIC-7899 Ultra160/m PCI SCSI Card
28	Adaptec AIC-7899 Ultra160/m PCI SCSI Card
21	Mylex AcceleRAID 352 Disk Array Controller
25	Mylex AcceleRAID 352 Disk Array Controller
24	Mylex AcceleRAID 352 Disk Array Controller

[Memory]

Range Device Status

0xA0000-0xBFFFF	PCI bus	OK
0xA0000-0xBFFFF	ATI Technologies Inc. RAGE XL PCI	OK
0xFD000000-0xFE3FFFFF	PCI bus	OK
0xFD000000-0xFE3FFFFF	ATI Technologies Inc. RAGE XL PCI	OK
0xFEB00000-0xFEBFFFFF	PCI bus	OK
0xFEB00000-0xFEBFFFFF	Intel(R) PRO/100+ PCI Adapter	OK
0xFE000000-0xFE0FFFFF	Intel(R) PRO/100+ PCI Adapter	OK
0xFE300000-0xFE300FFF	ATI Technologies Inc. RAGE XL PCI	OK
0x0000-0x9FFFF	System board	OK
0x100000-0x8FFFFFFF	System board	OK
0xF0000-0xFFFFF	System board	OK
0xFEC00000-0xFEC0FFFF	System board	OK
0xFEE00000-0xFEE0FFFF	System board	OK
0xFFE00000-0xFFFFFFF	System board	OK
0xFB000000-0xFC0FFFFF	PCI bus	OK
0xFE800000-0xFEAFFFFF	PCI bus	OK
0xFE900000-0xFEAFFFFF	PCI standard PCI-to-PCI bridge	OK
0xFE9FF000-0xFE9FFFFF	Adaptec AIC-7899 Ultra160/m PCI SCSI Card	OK
0xFE9FE000-0xFE9FEFFF	Adaptec AIC-7899 Ultra160/m PCI SCSI Card	OK
0xFC004000-0xFC005FFF	Mylex AcceleRAID 352 Disk Array Controller	OK
0xFC002000-0xFC003FFF	Mylex AcceleRAID 352 Disk Array Controller	OK
0xFC000000-0xFC001FFF	Mylex AcceleRAID 352 Disk Array Controller	OK

[Components]

[Following are sub-categories of this main category]

[Multimedia]

[Following are sub-categories of this main category]

[Audio Codecs]

Codec	Manufacturer	Description	Status	File	Version	Size	Creation Date
c:\winnt\system32\iac25_32.ax	Intel Corporation	Indeo® audio software	OK				
	C:\WINNT\System32\IAC25_32.AX			2.05.53	195.00 KB (199,680 bytes)		12/7/1999 6:00:00 AM

Appendix C – Tunable Parameters

c:\winnt\system32\msg723.acm Microsoft Corporation OK
 C:\WINNT\System32\MSG723.ACM 4.4.3385 106.77 KB (109,328 bytes)
 11/14/2001 3:46:25 PM

c:\winnt\system32\lhacm.acm Microsoft Corporation OK
 C:\WINNT\System32\LHACM.ACM 4.4.3385 33.27 KB (34,064 bytes)
 11/14/2001 3:46:26 PM

c:\winnt\system32\tssoft32.acm DSP GROUP, INC. OK
 C:\WINNT\System32\TSSOFT32.ACM 1.01 9.27 KB (9,488 bytes) 12/7/1999
 6:00:00 AM

c:\winnt\system32\msgsm32.acm Microsoft Corporation OK
 C:\WINNT\System32\MSGSM32.ACM 5.00.2134.1 22.27 KB (22,800 bytes)
 12/7/1999 6:00:00 AM

c:\winnt\system32\msg711.acm Microsoft Corporation OK
 C:\WINNT\System32\MSG711.ACM 5.00.2134.1 10.27 KB (10,512 bytes)
 12/7/1999 6:00:00 AM

c:\winnt\system32\msadp32.acm Microsoft Corporation OK
 C:\WINNT\System32\MSADP32.ACM 5.00.2134.1 14.77 KB (15,120 bytes)
 12/7/1999 6:00:00 AM

c:\winnt\system32\imaadp32.acm Microsoft Corporation OK
 C:\WINNT\System32\IMAADP32.ACM 5.00.2134.1 16.27 KB (16,656 bytes)
 12/7/1999 6:00:00 AM

[Video Codecs]

Codec	Manufacturer	Description	Status	File	Version	Size	Creation Date
c:\winnt\system32\ir50_32.dll	Intel Corporation				Indeo® video 5.10		OK
				C:\WINNT\System32\IR50_32.DLL	R.5.10.15.2.55	737.50 KB (755,200 bytes)	
							12/7/1999 6:00:00 AM
c:\winnt\system32\msh261.drv	Microsoft Corporation						OK
				C:\WINNT\System32\MSH261.DRV	4.4.3385	163.77 KB (167,696 bytes)	
							11/14/2001 3:46:25 PM
c:\winnt\system32\msh263.drv	Microsoft Corporation						OK
				C:\WINNT\System32\MSH263.DRV	4.4.3385	252.27 KB (258,320 bytes)	
							11/14/2001 3:45:46 PM
c:\winnt\system32\msvidc32.dll	Microsoft Corporation						OK
				C:\WINNT\System32\MSVIDC32.DLL	5.00.2134.1	27.27 KB (27,920 bytes)	
							12/7/1999 6:00:00 AM
c:\winnt\system32\ir32_32.dll	Intel(R) Corporation						OK
				C:\WINNT\System32\IR32_32.DLL	Not Available	194.50 KB (199,168 bytes)	
							12/7/1999 6:00:00 AM
c:\winnt\system32\iccvid.dll	Radius Inc.						OK
				C:\WINNT\System32\ICCVID.DLL	1.10.0.6	108.00 KB (110,592 bytes)	
							12/7/1999 6:00:00 AM
c:\winnt\system32\msrle32.dll	Microsoft Corporation						OK
				C:\WINNT\System32\MSRLE32.DLL	5.00.2134.1	10.77 KB (11,024 bytes)	
							12/7/1999 6:00:00 AM

[CD-ROM]

Item Value
 Drive D:
 Description CD-ROM Drive
 Media Loaded True
 Media Type CD-ROM
 Name TEAC CD-224E

Appendix C – Tunable Parameters

Manufacturer (Standard CD-ROM drives)
Status OK
Transfer Rate Not Available
SCSI Target ID 0
PNP Device ID IDE\CDROMTEAC_CD-
224E_____3.7D____\5&F3420B7&0&0.0.0

[Sound Device]

Item Value
No sound devices

[Display]

Item Value
Name ATI Technologies Inc. RAGE XL PCI
PNP Device ID PCI\VEN_1002&DEV_4752&SUBSYS_00D91028&REV_27\3&13C0B0C5&0&70
Adapter Type ATI RAGE XL PCI, ATI Technologies Inc. compatible
Adapter Description ATI Technologies Inc. RAGE XL PCI
Adapter RAM 8.00 MB (8,388,608 bytes)
Installed Driversatidrab.dll
Driver Version 5.00.2179.1
INF File display.inf (atirage3 section)
Color Planes 1
Color Table Entries 256
Resolution 1024 x 768 x 60 hertz
Bits/Pixel 8

[Infrared]

Item Value
No infrared devices

[Input]

[Following are sub-categories of this main category]

[Keyboard]

Item Value
Description Standard 101/102-Key or Microsoft Natural PS/2 Keyboard
Name Enhanced (101- or 102-key)
Layout 00000409
PNP Device ID ACPI\PNP0303\4&14E2F907&0
NumberOfFunctionKeys 12

[Pointing Device]

Item Value
Hardware Type PS/2 Compatible Mouse
Number of Buttons 2
Status OK

Appendix C – Tunable Parameters

PNP Device ID ACPI\PNP0F13\4&14E2F907&0
Power Management Supported False
Double Click Threshold 6
Handedness Right Handed Operation

[Modem]

Item Value
No modems

[Network]

[Following are sub-categories of this main category]

[Adapter]

Item Value
Name [00000000] Intel 8255x-based PCI Ethernet Adapter (10/100)
Adapter Type Not Available
Product Name Intel 8255x-based PCI Ethernet Adapter (10/100)
Installed True
PNP Device ID PCI\VEN_8086&DEV_1229&SUBSYS_009B1028&REV_08\3&13C0B0C5&0&20
Last Reset 11/30/2001 7:44:40 AM
Index 0
Service Name E100B
IP Address Not Available
IP Subnet Not Available
Default IP Gateway Not Available
DHCP Enabled False
DHCP Server Not Available
DHCP Lease Expires Not Available
DHCP Lease Obtained Not Available
MAC Address Not Available
Service Name E100B
Driver c:\winnt\system32\drivers\e100bnt5.sys (80144, 4.01.67.0000)

Name [00000001] RAS Async Adapter
Adapter Type Not Available
Product Name RAS Async Adapter
Installed True
PNP Device ID Not Available
Last Reset 11/30/2001 7:44:40 AM
Index 1
Service Name AsyncMac
IP Address Not Available
IP Subnet Not Available
Default IP Gateway Not Available
DHCP Enabled False
DHCP Server Not Available
DHCP Lease Expires Not Available
DHCP Lease Obtained Not Available
MAC Address Not Available
Service Name Not Available

Appendix C – Tunable Parameters

Name [00000002] WAN Miniport (L2TP)
Adapter Type Not Available
Product Name WAN Miniport (L2TP)
Installed True
PNP Device ID ROOT\MS_L2TPMINIPOINT\0000
Last Reset 11/30/2001 7:44:40 AM
Index 2
Service Name Rasl2tp
IP Address Not Available
IP Subnet Not Available
Default IP Gateway Not Available
DHCP Enabled False
DHCP Server Not Available
DHCP Lease Expires Not Available
DHCP Lease Obtained Not Available
MAC Address Not Available
Service Name Rasl2tp
Driver c:\winnt\system32\drivers\rasl2tp.sys (50800, 5.00.2179.1)

Name [00000003] WAN Miniport (PPTP)
Adapter Type Wide Area Network (WAN)
Product Name WAN Miniport (PPTP)
Installed True
PNP Device ID ROOT\MS_PPTPMINIPOINT\0000
Last Reset 11/30/2001 7:44:40 AM
Index 3
Service Name PptpMiniport
IP Address Not Available
IP Subnet Not Available
Default IP Gateway Not Available
DHCP Enabled False
DHCP Server Not Available
DHCP Lease Expires Not Available
DHCP Lease Obtained Not Available
MAC Address 50:50:54:50:30:30
Service Name PptpMiniport
Driver c:\winnt\system32\drivers\raspptp.sys (47856, 5.00.2160.1)

Name [00000004] Direct Parallel
Adapter Type Not Available
Product Name Direct Parallel
Installed True
PNP Device ID ROOT\MS_PTMINIPOINT\0000
Last Reset 11/30/2001 7:44:40 AM
Index 4
Service Name Raspti
IP Address Not Available
IP Subnet Not Available
Default IP Gateway Not Available
DHCP Enabled False
DHCP Server Not Available
DHCP Lease Expires Not Available
DHCP Lease Obtained Not Available
MAC Address Not Available
Service Name Raspti

Appendix C – Tunable Parameters

Driver c:\winnt\system32\drivers\raspti.sys (16880, 5.00.2146.1)

Name [00000005] WAN Miniport (IP)
Adapter Type Not Available
Product Name WAN Miniport (IP)
Installed True
PNP Device ID ROOT\MS_NDISWANIP\0000
Last Reset 11/30/2001 7:44:40 AM
Index 5
Service Name NdisWan
IP Address Not Available
IP Subnet Not Available
Default IP Gateway Not Available
DHCP Enabled False
DHCP Server Not Available
DHCP Lease Expires Not Available
DHCP Lease Obtained Not Available
MAC Address Not Available
Service Name NdisWan

Driver c:\winnt\system32\drivers\ndiswan.sys (90768, 5.00.2184.1)

Name [00000006] Intel(R) PRO/100+ PCI Adapter
Adapter Type Ethernet 802.3
Product Name Intel(R) PRO/100+ PCI Adapter
Installed True
PNP Device ID PCI\VEN_8086&DEV_1229&SUBSYS_00098086&REV_05\3&13C0B0C5&0&40
Last Reset 11/30/2001 7:44:40 AM
Index 6
Service Name E100B
IP Address 192.1.1.105
IP Subnet 255.255.255.0
Default IP Gateway Not Available
DHCP Enabled False
DHCP Server Not Available
DHCP Lease Expires Not Available
DHCP Lease Obtained Not Available
MAC Address 00:90:27:5C:D1:CC
Service Name E100B

IRQ Number 29

I/O Port 0xECA0-0xECBF

Driver c:\winnt\system32\drivers\e100bnt5.sys (80144, 4.01.67.0000)

[Protocol]

Item	Value
Name	MSAFD Tcpip [TCP/IP]
ConnectionlessService	False
GuaranteesDelivery	True
GuaranteesSequencing	True
MaximumAddressSize	16 bytes
MaximumMessageSize	0 bytes
MessageOriented	False
MinimumAddressSize	16 bytes
PseudoStreamOriented	False

Appendix C – Tunable Parameters

SupportsBroadcasting False
SupportsConnectData False
SupportsDisconnectData False
SupportsEncryption False
SupportsExpeditedData True
SupportsGracefulClosing True
SupportsGuaranteedBandwidth False
SupportsMulticasting False

Name MSAFD Tcpip [UDP/IP]
ConnectionlessService True
GuaranteesDelivery False
GuaranteesSequencing False
MaximumAddressSize 16 bytes
MaximumMessageSize 65467 bytes
MessageOriented True
MinimumAddressSize 16 bytes
PseudoStreamOriented False
SupportsBroadcasting True
SupportsConnectData False
SupportsDisconnectData False
SupportsEncryption False
SupportsExpeditedData False
SupportsGracefulClosing False
SupportsGuaranteedBandwidth False
SupportsMulticasting True

Name RSVP UDP Service Provider
ConnectionlessService True
GuaranteesDelivery False
GuaranteesSequencing False
MaximumAddressSize 16 bytes
MaximumMessageSize 65467 bytes
MessageOriented True
MinimumAddressSize 16 bytes
PseudoStreamOriented False
SupportsBroadcasting True
SupportsConnectData False
SupportsDisconnectData False
SupportsEncryption True
SupportsExpeditedData False
SupportsGracefulClosing False
SupportsGuaranteedBandwidth False
SupportsMulticasting True

Name RSVP TCP Service Provider
ConnectionlessService False
GuaranteesDelivery True
GuaranteesSequencing True
MaximumAddressSize 16 bytes
MaximumMessageSize 0 bytes
MessageOriented False
MinimumAddressSize 16 bytes
PseudoStreamOriented False
SupportsBroadcasting False

Appendix C – Tunable Parameters

SupportsConnectData False
SupportsDisconnectData False
SupportsEncryption True
SupportsExpeditedData True
SupportsGracefulClosing True
SupportsGuaranteedBandwidth False
SupportsMulticasting False

Name MSAFD NetBIOS [\Device\NetBT_Tcpip_{EFCEDC4B-3FA8-4735-A1BD-CF4C3ACE14AA}] SEQPACKET 3

ConnectionlessService False
GuaranteesDelivery True
GuaranteesSequencing True
MaximumAddressSize 20 bytes
MaximumMessageSize 64000 bytes
MessageOriented True
MinimumAddressSize 20 bytes
PseudoStreamOriented False
SupportsBroadcasting False
SupportsConnectData False
SupportsDisconnectData False
SupportsEncryption False
SupportsExpeditedData False
SupportsGracefulClosing False
SupportsGuaranteedBandwidth False
SupportsMulticasting False

Name MSAFD NetBIOS [\Device\NetBT_Tcpip_{EFCEDC4B-3FA8-4735-A1BD-CF4C3ACE14AA}] DATAGRAM 3

ConnectionlessService True
GuaranteesDelivery False
GuaranteesSequencing False
MaximumAddressSize 20 bytes
MaximumMessageSize 64000 bytes
MessageOriented True
MinimumAddressSize 20 bytes
PseudoStreamOriented False
SupportsBroadcasting True
SupportsConnectData False
SupportsDisconnectData False
SupportsEncryption False
SupportsExpeditedData False
SupportsGracefulClosing False
SupportsGuaranteedBandwidth False
SupportsMulticasting False

Name MSAFD NetBIOS [\Device\NetBT_Tcpip_{14473AB8-83BE-4449-89EB-8773383B11E4}] SEQPACKET 0

ConnectionlessService False
GuaranteesDelivery True
GuaranteesSequencing True
MaximumAddressSize 20 bytes
MaximumMessageSize 64000 bytes
MessageOriented True
MinimumAddressSize 20 bytes

Appendix C – Tunable Parameters

PseudoStreamOriented False
SupportsBroadcasting False
SupportsConnectData False
SupportsDisconnectData False
SupportsEncryption False
SupportsExpeditedData False
SupportsGracefulClosing False
SupportsGuaranteedBandwidth False
SupportsMulticasting False

Name MSAFD NetBIOS [\Device\NetBT_Tcpip_{14473AB8-83BE-4449-89EB-8773383B11E4}]
DATAGRAM 0

ConnectionlessService True
GuaranteesDelivery False
GuaranteesSequencing False
MaximumAddressSize 20 bytes
MaximumMessageSize 64000 bytes
MessageOriented True
MinimumAddressSize 20 bytes
PseudoStreamOriented False
SupportsBroadcasting True
SupportsConnectData False
SupportsDisconnectData False
SupportsEncryption False
SupportsExpeditedData False
SupportsGracefulClosing False
SupportsGuaranteedBandwidth False
SupportsMulticasting False

Name MSAFD NetBIOS [\Device\NetBT_Tcpip_{C9F873E3-D445-45F0-AD43-876E738A4DDD}] SEQPACKET 1

ConnectionlessService False
GuaranteesDelivery True
GuaranteesSequencing True
MaximumAddressSize 20 bytes
MaximumMessageSize 64000 bytes
MessageOriented True
MinimumAddressSize 20 bytes
PseudoStreamOriented False
SupportsBroadcasting False
SupportsConnectData False
SupportsDisconnectData False
SupportsEncryption False
SupportsExpeditedData False
SupportsGracefulClosing False
SupportsGuaranteedBandwidth False
SupportsMulticasting False

Name MSAFD NetBIOS [\Device\NetBT_Tcpip_{C9F873E3-D445-45F0-AD43-876E738A4DDD}] DATAGRAM 1

ConnectionlessService True
GuaranteesDelivery False
GuaranteesSequencing False
MaximumAddressSize 20 bytes
MaximumMessageSize 64000 bytes

Appendix C – Tunable Parameters

MessageOriented True
MinimumAddressSize 20 bytes
PseudoStreamOriented False
SupportsBroadcasting True
SupportsConnectData False
SupportsDisconnectData False
SupportsEncryption False
SupportsExpeditedData False
SupportsGracefulClosing False
SupportsGuaranteedBandwidth False
SupportsMulticasting False

Name MSAFD NetBIOS [\Device\NetBT_Tcpip_{B1245530-04ED-4CF6-BA78-66421E1F13A4}]
SEQPACKET 2

ConnectionlessService False
GuaranteesDelivery True
GuaranteesSequencing True
MaximumAddressSize 20 bytes
MaximumMessageSize 64000 bytes
MessageOriented True
MinimumAddressSize 20 bytes
PseudoStreamOriented False
SupportsBroadcasting False
SupportsConnectData False
SupportsDisconnectData False
SupportsEncryption False
SupportsExpeditedData False
SupportsGracefulClosing False
SupportsGuaranteedBandwidth False
SupportsMulticasting False

Name MSAFD NetBIOS [\Device\NetBT_Tcpip_{B1245530-04ED-4CF6-BA78-66421E1F13A4}]
DATAGRAM 2

ConnectionlessService True
GuaranteesDelivery False
GuaranteesSequencing False
MaximumAddressSize 20 bytes
MaximumMessageSize 64000 bytes
MessageOriented True
MinimumAddressSize 20 bytes
PseudoStreamOriented False
SupportsBroadcasting True
SupportsConnectData False
SupportsDisconnectData False
SupportsEncryption False
SupportsExpeditedData False
SupportsGracefulClosing False
SupportsGuaranteedBandwidth False
SupportsMulticasting False

[WinSock]

Item Value
File c:\winnt\system32\winsock.dll

Appendix C – Tunable Parameters

Version 3.10

Size 2.80 KB (2,864 bytes)

File c:\winnt\system32\wsock32.dll

Version 5.00.2152.1

Size 21.27 KB (21,776 bytes)

[Ports]

[Following are sub-categories of this main category]

[Serial]

Item	Value
Name	COM1
Status	OK
PNP Device ID	ACPI\PNP0501\1
Maximum Input Buffer Size	Not Available
Maximum Output Buffer Size	Not Available
Settable Baud Rate	Not Available
Settable Data Bits	Not Available
Settable Flow Control	Not Available
Settable Parity	Not Available
Settable Parity Check	Not Available
Settable Stop Bits	Not Available
Settable RLSD	Not Available
Supports RLSD	Not Available
Supports 16 Bit Mode	Not Available
Supports Special Characters	Not Available
Baud Rate	9600
Bits/Byte	8
Stop Bits	1
Parity	None
Busy	-1
Abort Read/Write on Error	Not Available
Binary Mode Enabled	Not Available
Continue XMit on XOff	Not Available
CTS Outflow Control	Not Available
Discard NULL Bytes	Not Available
DSR Outflow Control	Not Available
DSR Sensitivity	Not Available
DTR Flow Control Type	Not Available
EOF Character	Not Available
Error Replace Character	Not Available
Error Replacement Enabled	Not Available
Event Character	Not Available
Parity Check Enabled	-1
RTS Flow Control Type	Not Available
XOff Character	19
XOffXMit Threshold	512
XOn Character	17
XOnXMit Threshold	2048
XOnXOff InFlow Control	Not Available
XOnXOff OutFlow Control	Not Available

Appendix C – Tunable Parameters

IRQ Number 4
I/O Port 0x03F8-0x03FF
Driver c:\winnt\system32\drivers\serial.sys (62448, 5.00.2134.1)

Name COM2
Status OK
PNP Device ID ACPI\PNP0501\2
Maximum Input Buffer Size 0
Maximum Output Buffer Size False
Settable Baud Rate True
Settable Data Bits True
Settable Flow Control True
Settable Parity True
Settable Parity Check True
Settable Stop Bits True
Settable RLSD True
Supports RLSD True
Supports 16 Bit Mode False
Supports Special Characters False
Baud Rate 9600
Bits/Byte 8
Stop Bits 1
Parity None
Busy 0
Abort Read/Write on Error 0
Binary Mode Enabled -1
Continue XMit on XOff 0
CTS Outflow Control 0
Discard NULL Bytes 0
DSR Outflow Control 0
DSR Sensitivity 0
DTR Flow Control Type Enable
EOF Character 0
Error Replace Character 0
Error Replacement Enabled 0
Event Character 0
Parity Check Enabled 0
RTS Flow Control Type Enable
XOff Character 19
XOffXMit Threshold 512
XOn Character 17
XOnXMit Threshold 2048
XOnXOff InFlow Control 0
XOnXOff OutFlow Control 0
IRQ Number 3
I/O Port 0x02F8-0x02FF
Driver c:\winnt\system32\drivers\serial.sys (62448, 5.00.2134.1)

[Parallel]

Item Value
Name LPT1
PNP Device ID ACPI\PNP0401\4&14E2F907&0

Appendix C – Tunable Parameters

[Storage]

[Following are sub-categories of this main category]

[Drives]

Item Value

Drive A:

Description 3 1/2 Inch Floppy Drive

Drive C:

Description Local Fixed Disk

Compressed False

File System NTFS

Size 16.95 GB (18,202,509,312 bytes)

Free Space 13.10 GB (14,064,664,576 bytes)

Volume Name

Volume Serial Number A8757429

Partition Disk #0, Partition #0

Partition Size 16.95 GB (18,202,512,384 bytes)

Starting Offset 32256 bytes

Drive Description Disk drive

Drive Manufacturer (Standard disk drives)

Drive Model QUANTUM ATLAS IV 18 SCA SCSI Disk Device

Drive BytesPerSector 512

Drive MediaLoaded True

Drive MediaType Fixed hard disk media

Drive Partitions 1

Drive SCSIbus 0

Drive SCSILogicalUnit 0

Drive SCSIPort 1

Drive SCSTargetId 0

Drive SectorsPerTrack 63

Drive Size 18202544640 bytes

Drive TotalCylinders 2213

Drive TotalSectors 35551845

Drive TotalTracks 564315

Drive TracksPerCylinder 255

Drive E:

Description Local Fixed Disk

Compressed Not Available

File System Not Available

Size Not Available

Free Space Not Available

Volume Name Not Available

Volume Serial Number Not Available

Drive F:

Description Local Fixed Disk

Compressed Not Available

File System Not Available

Size Not Available

Free Space Not Available

Appendix C – Tunable Parameters

Volume Name Not Available
Volume Serial Number Not Available

Drive G:
Description Local Fixed Disk
Compressed Not Available
File System Not Available
Size Not Available
Free Space Not Available
Volume Name Not Available
Volume Serial Number Not Available

Drive H:
Description Local Fixed Disk
Compressed Not Available
File System Not Available
Size Not Available
Free Space Not Available
Volume Name Not Available
Volume Serial Number Not Available

Drive S:
Description Local Fixed Disk
Compressed Not Available
File System Not Available
Size Not Available
Free Space Not Available
Volume Name Not Available
Volume Serial Number Not Available

Drive X:
Description Local Fixed Disk
Compressed False
File System NTFS
Size 303.00 GB (325,342,724,096 bytes)
Free Space 262.38 GB (281,723,666,432 bytes)
Volume Name
Volume Serial Number 209DB805
Partition Disk #1, Partition #2
Partition Size 303.00 GB (325,342,725,120 bytes)
Starting Offset Not Available
Drive Description \\.\PHYSICALDRIVE1
Drive Manufacturer Not Available
Drive Model Not Available
Drive BytesPerSector 512
Drive MediaLoaded True
Drive MediaType Fixed hard disk media
Drive Partitions 3
Drive SCSIbus 2
Drive SCSILogicalUnit 0
Drive SCSIPort 3
Drive SCSTargetId 0
Drive SectorsPerTrack 63
Drive Size 436474483200 bytes
Drive TotalCylinders 53065

Appendix C – Tunable Parameters

Drive TotalSectors 852489225
Drive TotalTracks 13531575
Drive TracksPerCylinder 255

Drive Y:
Description Local Fixed Disk
Compressed False
File System NTFS
Size 303.00 GB (325,342,724,096 bytes)
Free Space 262.38 GB (281,723,666,432 bytes)
Volume Name
Volume Serial Number OCD21FB6
Partition Disk #2, Partition #2
Partition Size 303.00 GB (325,342,725,120 bytes)
Starting Offset Not Available
Drive Description \\.\PHYSICALDRIVE2
Drive Manufacturer Not Available
Drive Model Not Available
Drive BytesPerSector 512
Drive MediaLoaded True
Drive MediaType Fixed hard disk media
Drive Partitions 3
Drive SCSI Bus 2
Drive SCSI LogicalUnit 0
Drive SCSI Port 4
Drive SCSI TargetId 0
Drive SectorsPerTrack 63
Drive Size 436474483200 bytes
Drive TotalCylinders 53065
Drive TotalSectors 852489225
Drive TotalTracks 13531575
Drive TracksPerCylinder 255

[SCSI]

Item Value
Name Adaptec AIC-7899 Ultra160/m PCI SCSI Card
Caption Adaptec AIC-7899 Ultra160/m PCI SCSI Card
Driver adpu160m
Status OK
PNP Device ID
PCI\VEN_9005&DEV_00CF&SUBSYS_00D91028&REV_01\4&C3C07A3&0&2010
Device ID
PCI\VEN_9005&DEV_00CF&SUBSYS_00D91028&REV_01\4&C3C07A3&0&2010
Device Map Not Available
Index Not Available
Max Number Controlled Not Available
IRQ Number 26
I/O Port 0xDC00-0xDCFF
Driver c:\winnt\system32\drivers\adpu160m.sys (64432, v3.10a)

Name Adaptec AIC-7899 Ultra160/m PCI SCSI Card
Caption Adaptec AIC-7899 Ultra160/m PCI SCSI Card
Driver adpu160m

Appendix C – Tunable Parameters

Status OK
PNP Device ID
 PCIIVEN_9005&DEV_00CF&SUBSYS_00D91028&REV_01\4&C3C07A3&0&2110
Device ID
 PCIIVEN_9005&DEV_00CF&SUBSYS_00D91028&REV_01\4&C3C07A3&0&2110
Device Map Not Available
Index Not Available
Max Number Controlled Not Available
IRQ Number 28
I/O Port 0xD800-0xD8FF
Driver c:\winnt\system32\drivers\adpu160m.sys (64432, v3.10a)

Name Mylex AcceleRAID 352 Disk Array Controller
Caption Mylex AcceleRAID 352 Disk Array Controller
Driver dac2w2k
Status OK
PNP Device ID PCIIVEN_1069&DEV_0050&SUBSYS_00501069&REV_02\3&1070020&0&51
Device ID PCIIVEN_1069&DEV_0050&SUBSYS_00501069&REV_02\3&1070020&0&51
Device Map Not Available
Index Not Available
Max Number Controlled Not Available
IRQ Number 21
Driver c:\winnt\system32\drivers\dac2w2k.sys (185488, 6.00-03)

Name Mylex AcceleRAID 352 Disk Array Controller
Caption Mylex AcceleRAID 352 Disk Array Controller
Driver dac2w2k
Status OK
PNP Device ID PCIIVEN_1069&DEV_0050&SUBSYS_00501069&REV_02\3&1070020&0&61
Device ID PCIIVEN_1069&DEV_0050&SUBSYS_00501069&REV_02\3&1070020&0&61
Device Map Not Available
Index Not Available
Max Number Controlled Not Available
IRQ Number 25
Driver c:\winnt\system32\drivers\dac2w2k.sys (185488, 6.00-03)

Name Mylex AcceleRAID 352 Disk Array Controller
Caption Mylex AcceleRAID 352 Disk Array Controller
Driver dac2w2k
Status OK
PNP Device ID PCIIVEN_1069&DEV_0050&SUBSYS_00501069&REV_02\3&1070020&0&71
Device ID PCIIVEN_1069&DEV_0050&SUBSYS_00501069&REV_02\3&1070020&0&71
Device Map Not Available
Index Not Available
Max Number Controlled Not Available
IRQ Number 24
Driver c:\winnt\system32\drivers\dac2w2k.sys (185488, 6.00-03)

[Printing]

Name Port Name Server Name
No printing information

[Problem Devices]

Appendix C – Tunable Parameters

Device PNP Device ID Error Code

Intel 8255x-based PCI Ethernet Adapter (10/100)

PCI\VEN_8086&DEV_1229&SUBSYS_009B1028&REV_08\3&13C0B0C5&0&2022

Secondary IDE ChannelPCI\IDE\IDECHANNEL\4&328CD2DD&0&1 12

Dell 12 BAY U2W CU SCSI Processor Device

SCSI\PROCESSOR&VEN_DELL&PROD_12_BAY_U2W_CU&REV_0209\4&DDC9335&0&0F0 28

Dell 12 BAY U2W CU SCSI Processor Device

SCSI\PROCESSOR&VEN_DELL&PROD_12_BAY_U2W_CU&REV_0209\4&DDC9335&0&1F0 28

Dell 12 BAY U2W CU SCSI Processor Device

SCSI\PROCESSOR&VEN_DELL&PROD_12_BAY_U2W_CU&REV_0209\4&1B21AEB&0&0F0 28

Dell 12 BAY U2W CU SCSI Processor Device

SCSI\PROCESSOR&VEN_DELL&PROD_12_BAY_U2W_CU&REV_0209\4&1B21AEB&0&1F0 28

DELL 2x3 U2W SCSI BP SCSI Processor Device

SCSI\PROCESSOR&VEN_DELL&PROD_2X3_U2W_SCISI_BP&REV_1.23\4&540ED9&0&060 28

DELL 2x3 U2W SCSI BP SCSI Processor Device

SCSI\PROCESSOR&VEN_DELL&PROD_2X3_U2W_SCISI_BP&REV_1.29\4&540ED9&0&160 28

[USB]

Device PNP Device ID

No USB Devices

[Software Environment]

[Following are sub-categories of this main category]

[Drivers]

Name	Description	File	Type	Started	Start Mode	State	Status	Error Control
	Accept Pause	Accept	Stop					
abiosdsk	Abiosdsk		Not Available	Stopped	Kernel Driver	False	Disabled	
	Stopped	OK	Ignore	False	False			
abp480n5	abp480n5		Not Available	Stopped	Kernel Driver	False	Disabled	
	Stopped	OK	Normal	False	False			
acpi	Microsoft ACPI Driver	c:\winnt\system32\drivers\acpi.sys		Running	Kernel Driver	True	True	
	Boot	Running	OK	Normal	False	True		
acpiec	ACPIEC	c:\winnt\system32\drivers\acpiec.sys		Stopped	Kernel Driver	False	False	
	Disabled	Stopped	OK	Normal	False	False		
adpu160m	adpu160m	c:\winnt\system32\drivers\adpu160m.sys		Running	Kernel Driver	True		
	True	Boot	Running	OK	Normal	False	True	
afd	AFD Networking Support Environment	c:\winnt\system32\drivers\afd.sys		Running	Kernel	True		
	Driver	True	Auto	Running	OK	Normal	False	True
aha154x	Aha154x		Not Available	Stopped	Kernel Driver	False	Disabled	
	Stopped	OK	Normal	False	False			
aic116xaic116x	Not Available		Kernel Driver	False	Disabled	Stopped	OK	
	Normal	False	False					
aic78u2aic78u2	Not Available		Kernel Driver	False	Disabled	Stopped	OK	
	Normal	False	False					

Appendix C – Tunable Parameters

aic78xx	aic78xx	Not Available	Kernel Driver	False	Disabled	Stopped	OK
	Normal	False	False				
ami0nt	ami0nt	Not Available	Kernel Driver	False	Disabled	Stopped	OK
	Normal	False	False				
amsint	amsint	Not Available	Kernel Driver	False	Disabled	Stopped	OK
	Normal	False	False				
asc	asc	Not Available	Kernel Driver	False	Disabled	Stopped	OK
	Normal	False	False				
asc3350p	asc3350p	Not Available	Kernel Driver	False	Disabled		
	Stopped	OK	Normal	False	False		
asc3550	asc3550	Not Available	Kernel Driver	False	Disabled		
	Stopped	OK	Normal	False	False		
asynmac	RAS Asynchronous Media Driver					c:\winnt\system32\drivers\asynmac.sys	
	Kernel Driver	False	Manual	Stopped	OK	Normal	False
atapi	Standard IDE/ESDI Hard Disk Controller					c:\winnt\system32\drivers\atapi.sys	Kernel
Driver	True	Boot	Running	OK	Normal	False	True
atdisk	Atdisk	Not Available	Kernel Driver	False	Disabled	Stopped	OK
	Ignore	False	False				
atirage3	atirage3					c:\winnt\system32\drivers\atimpab.sys	Kernel Driver
	Manual	Running	OK	Ignore	False	True	True
atmarpc	ATM ARP Client Protocol					c:\winnt\system32\drivers\atmarpc.sys	Kernel
Driver	False	Manual	Stopped	OK	Normal	False	False
audstub	Audio Stub Driver					c:\winnt\system32\drivers\audstub.sys	Kernel Driver
	Manual	Running	OK	Normal	False	True	True
beep	Beep					c:\winnt\system32\drivers\beep.sys	Kernel Driver
	Running	OK	Normal	False	True		True
buslogic	BusLogic	Not Available	Kernel Driver	False	Disabled		
	Stopped	OK	Normal	False	False		
cd20xrnt	cd20xrnt	Not Available	Kernel Driver	False	Disabled		
	Stopped	OK	Normal	False	False		
cdaudio	Cdaudio					c:\winnt\system32\drivers\cdaudio.sys	Kernel Driver
	Stopped	OK	Ignore	False	False		False
cdfs	Cdfs					c:\winnt\system32\drivers\cdfs.sys	File System Driver
	Disabled	Running	OK	Normal	False	True	True
cdrom	CD-ROM Driver					c:\winnt\system32\drivers\cdrom.sys	Kernel Driver
	Running	OK	Normal	False	True		True
changer	Changer	Not Available	Kernel Driver	False	System	Stopped	
	OK	Ignore	False	False			
cpqarray	Cpqarray	Not Available	Kernel Driver	False	Disabled		
	Stopped	OK	Normal	False	False		
cpqarry2	cpqarry2	Not Available	Kernel Driver	False	Disabled		
	Stopped	OK	Normal	False	False		
cpqfcalm	cpqfcalm	Not Available	Kernel Driver	False	Disabled		
	Stopped	OK	Normal	False	False		
cpqfws2e	cpqfws2e	Not Available	Kernel Driver	False	Disabled		
	Stopped	OK	Normal	False	False		
dac2w2k	dac2w2k					c:\winnt\system32\drivers\dac2w2k.sys	Kernel Driver
	Boot	Running	OK	Normal	False	True	True
dac960nt	dac960nt	Not Available	Kernel Driver	False	Disabled		
	Stopped	OK	Normal	False	False		
deckzpsx	deckzpsx	Not Available	Kernel Driver	False	Disabled		
	Stopped	OK	Normal	False	False		
dfsdriver	DfsDriver					c:\winnt\system32\drivers\dfs.sys	File System Driver
	True	Boot	Running	OK	Normal	False	True

Appendix C – Tunable Parameters

disk	Disk Driver	c:\winnt\system32\drivers\disk.sys	Kernel Driver	True	Boot		
	Running	OK	Normal	False	True		
diskperf	Diskperf	c:\winnt\system32\drivers\diskperf.sys	Kernel Driver	True	Boot		
	Running	OK	Normal	False	True		
dmboot	dmboot	c:\winnt\system32\drivers\dmboot.sys	Kernel Driver	False	Disabled		
	Stopped	OK	Normal	False	False		
dmio	Logical Disk Manager Driver	c:\winnt\system32\drivers\dmio.sys	Kernel Driver				
	True	Boot	Running	OK	Normal	False	True
dmload	dmload	c:\winnt\system32\drivers\dmload.sys	Kernel Driver	True	Boot		
	Running	OK	Normal	False	True		
e100b	Intel PRO Adapter Driver	c:\winnt\system32\drivers\e100bnt5.sys	Kernel Driver				
	True	Manual	Running	OK	Normal	False	True
efs	EFS	c:\winnt\system32\drivers\efs.sys	File System Driver		True		
	Disabled	Running	OK	Normal	False	True	
fastfat	Fastfat	c:\winnt\system32\drivers\fastfat.sys	File System Driver		True		
	Disabled	Running	OK	Normal	False	True	
fd16_700	Fd16_700	Not Available	Kernel Driver	False	Disabled		
	Stopped	OK	Normal	False	False		
fdc	Floppy Disk Controller Driver	c:\winnt\system32\drivers\fdc.sys	Kernel Driver				
	True	Manual	Running	OK	Normal	False	True
fireport	fireport	Not Available	Kernel Driver	False	Disabled	Stopped	OK
	Normal	False	False				
flashpnt	flashpnt	Not Available	Kernel Driver	False	Disabled	Stopped	OK
	Normal	False	False				
flpydisk	Floppy Disk Driver	c:\winnt\system32\drivers\flpydisk.sys	Kernel Driver	True			
	Manual	Running	OK	Normal	False	True	
ftdisk	Volume Manager Driver	c:\winnt\system32\drivers\ftdisk.sys	Kernel Driver	True			
	Boot	Running	OK	Normal	False	True	
gamdrv	gamdrv	c:\winnt\system32\drivers\gamdrv.sys	Kernel Driver	True	Boot		
	Running	OK	Normal	False	True		
gpc	Generic Packet Classifier	c:\winnt\system32\drivers\msgpc.sys	Kernel Driver				
	True	Manual	Running	OK	Normal	False	True
i8042prt	i8042 Keyboard and PS/2 Mouse Port Driver	c:\winnt\system32\drivers\i8042prt.sys	Kernel Driver	True	System	Running	
	OK	Normal	False	True			
ini910u	ini910u	Not Available	Kernel Driver	False	Disabled	Stopped	OK
	Normal	False	False				
intelide	IntelIde	Not Available	Kernel Driver	False	Disabled	Stopped	OK
	Normal	False	False				
ipfilterdriver	IP Traffic Filter Driver	c:\winnt\system32\drivers\ipfltdrv.sys	Kernel Driver				
	False	Manual	Stopped	OK	Normal	False	False
ipinip	IP in IP Tunnel Driver	c:\winnt\system32\drivers\ipinip.sys	Kernel Driver	False			
	Manual	Stopped	OK	Normal	False	False	
ipnat	IP Network Address Translator	c:\winnt\system32\drivers\ipnat.sys	Kernel Driver				
	False	Manual	Stopped	OK	Normal	False	False
ipsec	IPSEC driver	c:\winnt\system32\drivers\ipsec.sys	Kernel Driver	False	Manual		
	Stopped	OK	Normal	False	False		
ipsraidn	ipsraidn	Not Available	Kernel Driver	False	Disabled	Stopped	OK
	Normal	False	False				
isapnp	PnP ISA/EISA Bus Driver	c:\winnt\system32\drivers\isapnp.sys	Kernel Driver				
	True	Boot	Running	OK	Critical	False	True
kbdclass	Keyboard Class Driver	c:\winnt\system32\drivers\kbdclass.sys	Kernel Driver				
	True	System	Running	OK	Normal	False	True
ksecdd	KSecDD	c:\winnt\system32\drivers\ksecdd.sys	Kernel Driver	True	Boot		
	Running	OK	Normal	False	True		

Appendix C – Tunable Parameters

lbrtfdc	lbrtfdc	Not Available	Kernel Driver	False	System Stopped	OK	Ignore
	False	False					
lp6nds35	lp6nds35	Not Available	Kernel Driver	False	Disabled		
	Stopped	OK	Normal	False	False		
macdisk	macdisk	c:\winnt\system32\drivers\mac2w2k.sys	Kernel Driver	True			True
	Boot	Running	OK	Normal	False	True	
mnmdd	mnmdd	c:\winnt\system32\drivers\mnmdd.sys	Kernel Driver	True	System		
	Running	OK	Ignore	False	True		
modem	Modem	c:\winnt\system32\drivers\modem.sys	Kernel Driver	False	Manual		
	Stopped	OK	Ignore	False	False		
mouclass	Mouse Class Driver	c:\winnt\system32\drivers\mouclass.sys	Kernel Driver				
	True	System Running	OK	Normal	False	True	
mountmgr	MountMgr	c:\winnt\system32\drivers\mountmgr.sys	Kernel Driver	True			True
	Boot	Running	OK	Normal	False	True	
mraid2k	mraid2k	c:\winnt\system32\drivers\mraid2k.sys	Kernel Driver	True	Boot		
	Running	OK	Normal	False	True		
mraid35x	mraid35x	Not Available	Kernel Driver	False	Disabled		
	Stopped	OK	Normal	False	False		
mrx smb	MRXSMB	c:\winnt\system32\drivers\mrx smb.sys	File System Driver	True			True
	System Running	OK	Normal	False	True		
msfs	Msfs	c:\winnt\system32\drivers\msfs.sys	File System Driver	True	System		
	Running	OK	Normal	False	True		
mskssrv	Microsoft Streaming Service Proxy	c:\winnt\system32\drivers\mskssrv.sys	Kernel Driver	False	Manual Stopped	OK	Normal False False
	Kernel Driver	False	Manual Stopped	OK	Normal False False		
mspclock	Microsoft Streaming Clock Proxy	c:\winnt\system32\drivers\mspclock.sys	Kernel Driver	False	Manual Stopped	OK	Normal False False
	Kernel Driver	False	Manual Stopped	OK	Normal False False		
mspqm	Microsoft Streaming Quality Manager Proxy	c:\winnt\system32\drivers\mspqm.sys	Kernel Driver	False	Manual Stopped	OK	Normal False False
	Kernel Driver	False	Manual Stopped	OK	Normal False False		
mup	Mup	c:\winnt\system32\drivers\mup.sys	File System Driver	True	Boot		
	Running	OK	Normal	False	True		
ncrc710	Ncrc710	Not Available	Kernel Driver	False	Disabled	Stopped	
	OK	Normal	False	False			
ndis	NDIS System Driver	c:\winnt\system32\drivers\ndis.sys	Kernel Driver	True			True
	Boot	Running	OK	Normal	False	True	
ndistapi	Remote Access NDIS TAPI Driver	c:\winnt\system32\drivers\ndistapi.sys	Kernel Driver	True	Manual Running	OK	Normal False True
	Driver	True	Manual Running	OK	Normal False True		
ndiswan	Remote Access NDIS WAN Driver	c:\winnt\system32\drivers\ndiswan.sys	Kernel Driver	True	Manual Running	OK	Normal False True
	Kernel Driver	True	Manual Running	OK	Normal False True		
ndproxy	NDIS Proxy	c:\winnt\system32\drivers\ndproxy.sys	Kernel Driver	True	Manual		
	Running	OK	Normal	False	True		
netbios	NetBIOS Interface	c:\winnt\system32\drivers\netbios.sys	File System Driver				
	True	System Running	OK	Normal	False	True	
netbt	NetBios over Tcpip	c:\winnt\system32\drivers\netbt.sys	Kernel Driver	True			
	System Running	OK	Normal	False	True		
netdetect	NetDetect	c:\winnt\system32\drivers\netdtect.sys	Kernel Driver	False			
	Manual Stopped	OK	Normal	False	False		
npfs	Npfs	c:\winnt\system32\drivers\npfs.sys	File System Driver	True	System		
	Running	OK	Normal	False	True		
ntfs	Ntfs	c:\winnt\system32\drivers\ntfs.sys	File System Driver	True			
	Disabled	Running	OK	Normal	False	True	
null	Null	c:\winnt\system32\drivers\null.sys	Kernel Driver	True	System		
	Running	OK	Normal	False	True		
nwlnkflt	IPX Traffic Filter Driver	c:\winnt\system32\drivers\nwlnkflt.sys	Kernel Driver	False			
	Manual Stopped	OK	Normal	False	False		

Appendix C – Tunable Parameters

nwlkfw	IPX Traffic Forwarder Driver	c:\winnt\system32\drivers\nwlkfw.sys	Kernel Driver	False	Manual	Stopped	OK	Normal	False	False			
parallel	Parallel class driver	c:\winnt\system32\drivers\parallel.sys	Kernel Driver	True	Running	OK	Normal	False	True				
parport	Parallel port driver	c:\winnt\system32\drivers\parport.sys	Kernel Driver	True	System	Running	OK	Ignore	False	True			
partmgr	PartMgr	c:\winnt\system32\drivers\partmgr.sys	Kernel Driver	True	Running	OK	Normal	False	True		Boot		
parvdm	ParVdm	c:\winnt\system32\drivers\parvdm.sys	Kernel Driver	True	Running	OK	Ignore	False	True		Auto		
pci	PCI Bus Driver	c:\winnt\system32\drivers\pci.sys	Kernel Driver	True	Running	OK	Critical	False	True		Boot		
pcidump	PCIDump		Kernel Driver	False	OK	Ignore	False	False			System	Stopped	
pciide	PCIIde	c:\winnt\system32\drivers\pciide.sys	Kernel Driver	True	Running	OK	Normal	False	True		Boot		
pcmcia	Pcmcia	c:\winnt\system32\drivers\pcmcia.sys	Kernel Driver	False	Stopped	OK	Normal	False	False		Disabled		
pdcomp	PDCOMP		Kernel Driver	False	Ignore	False	False				Manual	Stopped	OK
pdframe	PDFRAME		Kernel Driver	False	OK	Ignore	False	False			Manual	Stopped	
pdreli	PDRELI		Kernel Driver	False	Ignore	False	False				Manual	Stopped	OK
pdframe	PDRFRAME		Kernel Driver	False	OK	Ignore	False	False			Manual	Stopped	
pptpminiport	WAN Miniport (PPTP)	c:\winnt\system32\drivers\raspptp.sys	Kernel Driver	True	Running	OK	Normal	False	True				
ptilink	Direct Parallel Link Driver	c:\winnt\system32\drivers\ptilink.sys	Kernel Driver	True	Running	OK	Normal	False	True				
ql1080	ql1080		Kernel Driver	False	Normal	False	False				Stopped	OK	
ql10wnt	QL10wnt		Kernel Driver	False	OK	Normal	False	False			Stopped		
ql1240	ql1240		Kernel Driver	False	Normal	False	False				Stopped	OK	
ql2100	ql2100		Kernel Driver	False	Normal	False	False				Stopped	OK	
rasacd	Remote Access Auto Connection Driver	c:\winnt\system32\drivers\rasacd.sys	Kernel Driver	True	Running	OK	Normal	False	True				
rasl2tp	WAN Miniport (L2TP)	c:\winnt\system32\drivers\rasl2tp.sys	Kernel Driver	True	Running	OK	Normal	False	True				
raspti	Direct Parallel	c:\winnt\system32\drivers\raspti.sys	Kernel Driver	True	Running	OK	Normal	False	True		Manual		
rca	Microsoft Streaming Network Raw Channel Access	c:\winnt\system32\drivers\rca.sys	Kernel Driver	False	OK	Normal	False	False			Manual	Stopped	
rdbss	Rdbss	c:\winnt\system32\drivers\rdbss.sys	File System Driver	True	Running	OK	Normal	False	True		System		
rdpwd	RDPWD	c:\winnt\system32\drivers\rdpwd.sys	Kernel Driver	False	Stopped	OK	Ignore	False	False		Manual		
redbook	Digital CD Audio Playback Filter Driver	c:\winnt\system32\drivers\redbook.sys	Kernel Driver	False	System	Stopped	OK	Normal	False	False			
serenum	Serenum Filter Driver	c:\winnt\system32\drivers\serenum.sys	Kernel Driver	True	Running	OK	Normal	False	True				

Appendix C – Tunable Parameters

serial	Serial port driver	c:\winnt\system32\drivers\serial.sys	Kernel Driver	True				
	System Running	OK	Ignore	False	True			
sfloppy	Sfloppy	c:\winnt\system32\drivers\sfloppy.sys	Kernel Driver	False	System			
	Stopped	OK	Ignore	False	False			
sglfb	sglfb	Not Available	Kernel Driver	False	System Stopped	OK	Normal	
	False	False						
simbad	Simbad	Not Available	Kernel Driver	False	Disabled	Stopped	OK	
	Normal	False	False					
sparrow	Sparrow	Not Available	Kernel Driver	False	Disabled	Stopped		
	OK	Normal	False	False				
srv	Srv	c:\winnt\system32\drivers\srv.sys	File System Driver	True	Manual			
	Running	OK	Normal	False	True			
swenum	Software Bus Driver	c:\winnt\system32\drivers\swenum.sys	Kernel Driver					
	True	Manual	Running	OK	Normal	False	True	
symc810	symc810	Not Available	Kernel Driver	False	Disabled			
	Stopped	OK	Normal	False	False			
symc8xx	symc8xx	Not Available	Kernel Driver	False	Disabled			
	Stopped	OK	Normal	False	False			
sym_hi	sym_hi	Not Available	Kernel Driver	False	Disabled	Stopped	OK	
	Normal	False	False					
tcpip	TCP/IP Protocol Driver	c:\winnt\system32\drivers\tcpip.sys	Kernel Driver	True				
	System Running	OK	Normal	False	True			
tdasync	TDASYNC	c:\winnt\system32\drivers\tdasync.sys	Kernel Driver	False	Manual			
	Stopped	OK	Ignore	False	False			
tdipx	TDIPX	c:\winnt\system32\drivers\tdipx.sys	Kernel Driver	False	Manual			
	Stopped	OK	Ignore	False	False			
tdnetb	TDNETB	c:\winnt\system32\drivers\tdnetb.sys	Kernel Driver	False	Manual			
	Stopped	OK	Ignore	False	False			
tdpipe	TDPIPE	c:\winnt\system32\drivers\tdpipe.sys	Kernel Driver	False	Manual			
	Stopped	OK	Ignore	False	False			
tdspix	TDSPX	c:\winnt\system32\drivers\tdspix.sys	Kernel Driver	False	Manual			
	Stopped	OK	Ignore	False	False			
tdtcp	TDTCP	c:\winnt\system32\drivers\tdtcp.sys	Kernel Driver	False	Manual			
	Stopped	OK	Ignore	False	False			
termdd	Terminal Device Driver	c:\winnt\system32\drivers\termdd.sys	Kernel Driver	False				
	Disabled	Stopped	OK	Normal	False	False		
tga	tga	Not Available	Kernel Driver	False	System Stopped	OK	Ignore	
	False	False						
udfs	Udfs	c:\winnt\system32\drivers\udfs.sys	File System Driver	False				
	Disabled	Stopped	OK	Normal	False	False		
ultra66	ultra66	Not Available	Kernel Driver	False	Disabled	Stopped	OK	
	Normal	False	False					
update	Microcode Update Driver	c:\winnt\system32\drivers\update.sys	Kernel Driver					
	True	Manual	Running	OK	Normal	False	True	
vgasave	VgaSave	c:\winnt\system32\drivers\vga.sys	Kernel Driver	True				
	System Running	OK	Ignore	False	True			
wanarp	Remote Access IP ARP Driver	c:\winnt\system32\drivers\wanarp.sys	Kernel Driver					
	True	Manual	Running	OK	Normal	False	True	
wdica	WDICA	Not Available	Kernel Driver	False	Manual Stopped	OK	Ignore	
	False	False						

[Environment Variables]

Variable	Value	User Name
ComSpec	%SystemRoot%\system32\cmd.exe	<SYSTEM>

Dell 197 DEC 14, 2001
 TPC-C Full Disclosure Report
 Copyright Dell

Appendix C – Tunable Parameters

```

NUMBER_OF_PROCESSORS 1 <SYSTEM>
OS Windows_NT <SYSTEM>
Os2LibPath %SystemRoot%\system32\os2\dll; <SYSTEM>
Path
    %SystemRoot%\system32;%SystemRoot%;%SystemRoot%\System32\Wbem;C:\Program
Files\Microsoft SQL Server\80\Tools\BINN;C:\Program Files\Microsoft SQL
Server\MSSQL\Binn;C:\MSTPCC.422\SETUP\scripts\utility;. <SYSTEM>
PATHEXT .COM;.EXE;.BAT;.CMD;.VBS;.VBE;.JS;.JSE;.WSF;.WSH <SYSTEM>
PROCESSOR_ARCHITECTURE x86 <SYSTEM>
PROCESSOR_IDENTIFIER x86 Family 6 Model 11 Stepping 1, GenuineIntel <SYSTEM>
PROCESSOR_LEVEL 6 <SYSTEM>
PROCESSOR_REVISION 0b01 <SYSTEM>
TEMP %SystemRoot%\TEMP <SYSTEM>
TMP %SystemRoot%\TEMP <SYSTEM>
windir %SystemRoot% <SYSTEM>
TEMP %USERPROFILE%\Local Settings\Temp PE2500\Administrator
TMP %USERPROFILE%\Local Settings\Temp PE2500\Administrator

```

[Jobs]

[Following are sub-categories of this main category]

[Print]

Document	Size	Owner	Notify	Status	Time Submitted	Start Time	Until Time
Elapsed Time	Pages	Printed	Job ID	Priority	Parameters	Driver Name	Print
Processor	Host	Print Queue	Data Type	Name			
Unknown	Unknown	Unknown	Unknown	Unknown	Unknown	Unknown	Unknown
Unknown	Unknown	Unknown	Unknown	Unknown	Unknown	Unknown	Unknown
Unknown	Unknown	Unknown	Unknown	Unknown	Unknown	Unknown	Unknown

[Network Connections]

Local Name	Remote Name	Type	Status	User Name
No network connections information				

[Running Tasks]

Name	Path	Process ID	Priority	Min Working Set	Max Working Set	Start
Time	Version	Size	File Date			
system idle process		Not Available	0	0	Not Available	Not Available
Available	Unknown	Unknown	Unknown	Unknown		Not
system	Not Available	8	8	0	1413120	Not Available
	Unknown	Unknown				Unknown
smss.exe	c:\winnt\system32\smss.exe		160	11	204800	1413120
	11/30/2001 1:45:04 PM	5.00.2170.1	44.27 KB (45,328 bytes)	12/7/1999 6:00:00 AM		
csrss.exe	Not Available	184	13	Not Available	Not Available	11/30/2001
1:45:07 PM	Unknown	Unknown	Unknown			
winlogon.exe	c:\winnt\system32\winlogon.exe		204	13	204800	1413120
	11/30/2001 1:45:09 PM	5.00.2182.1	173.27 KB (177,424 bytes)	12/7/1999		
6:00:00 AM						
services.exe	c:\winnt\system32\services.exe		232	9	204800	1413120
	11/30/2001 1:45:10 PM	5.00.2134.1	86.77 KB (88,848 bytes)	12/7/1999 6:00:00 AM		

Appendix C – Tunable Parameters

```

lsass.exe      c:\winnt\system32\lsass.exe  244  13  204800 1413120
               11/30/2001 1:45:10 PM5.00.2184.1 32.77 KB (33,552 bytes)12/7/1999 6:00:00 AM
svchost.exe   c:\winnt\system32\svchost.exe 400  8  204800 1413120
               11/30/2001 1:45:13 PM5.00.2134.1 7.77 KB (7,952 bytes) 12/7/1999 6:00:00 AM
msdtc.exe     c:\winnt\system32\msdtc.exe  428  8  204800 1413120
               11/30/2001 1:45:14 PM1999.9.3421.3 6.77 KB (6,928 bytes) 11/14/2001 9:43:33 AM
svchost.exe   c:\winnt\system32\svchost.exe 532  8  204800 1413120
               11/30/2001 1:45:16 PM5.00.2134.1 7.77 KB (7,952 bytes) 12/7/1999 6:00:00 AM
svchost.exe   c:\winnt\system32\svchost.exe 560  8  204800 1413120
               11/30/2001 1:45:16 PM5.00.2134.1 7.77 KB (7,952 bytes) 12/7/1999 6:00:00 AM
winmgmt.exe   c:\winnt\system32\wbem\winmgmt.exe 572  8  204800 1413120
               11/30/2001 1:45:16 PM1.50.1085.0001188.05 KB (192,567 bytes) 12/7/1999
6:00:00 AM
explorer.exe  c:\winnt\explorer.exe  680  8  204800 1413120 11/30/2001
1:45:24 PM 5.00.2920.0000232.77 KB (238,352 bytes) 12/7/1999 6:00:00 AM
gamscm.exe    c:\winnt\system32\gamscm.exe  628  8  204800
1413120 11/30/2001 1:45:53 PMNot Available 119.28 KB (122,144 bytes)
11/15/2001 11:01:30 AM
gamscm.exe    c:\winnt\system32\gamscm.exe  628  8  204800
1413120 11/30/2001 1:45:53 PMNot Available 119.28 KB (122,144 bytes)
11/15/2001 11:01:30 AM
gamscm.exe    c:\winnt\system32\gamscm.exe  628  8  204800
1413120 11/30/2001 1:45:53 PMNot Available 119.28 KB (122,144 bytes)
11/15/2001 11:01:30 AM
gamevent.exe  c:\winnt\system32\gamscm\gamevent.exe 604  13  204800
1413120 11/30/2001 1:45:53 PMNot Available 88.71 KB (90,834 bytes)
11/15/2001 11:01:30 AM
gamevlog.exe  c:\winnt\system32\gamscm\gamevlog.exe 840  13  204800
1413120 11/30/2001 1:45:53 PMNot Available 186.85 KB (191,330 bytes)
11/15/2001 11:01:30 AM
cmd.exe       c:\winnt\system32\cmd.exe  928  8  204800 1413120
               11/30/2001 1:51:15 PM5.00.2144.1 230.77 KB (236,304 bytes) 12/7/1999
6:00:00 AM
sqlservr.exe  c:\program files\microsoft sql server\mssql\binn\sqlservr.exe 868  13
204800 1413120 11/30/2001 1:51:15 PM2000.080.0384.00 7.05 MB
(7,397,457 bytes) 11/14/2001 4:15:18 PM
mmc.exe       c:\winnt\system32\mmc.exe  292  8  204800 1413120
               11/30/2001 2:57:26 PM5.00.2153.1 589.27 KB (603,408 bytes) 12/7/1999
6:00:00 AM
rsvp.exe      c:\winnt\system32\rsvp.exe  1020  8  204800 1413120
               11/30/2001 3:03:09 PM5.00.2167.1 172.77 KB (176,912 bytes) 12/7/1999
6:00:00 AM

```

[Loaded Modules]

Name	Version	Size	File Date	Manufacturer	Path
traffic.dll	5.00.2139.1	30.77 KB (31,504 bytes)	12/7/1999 6:00:00 AM	Microsoft Corporation	c:\winnt\system32\traffic.dll
rsvp.exe	5.00.2167.1	172.77 KB (176,912 bytes)	12/7/1999 6:00:00 AM	Microsoft Corporation	c:\winnt\system32\rsvp.exe
wbemprox.dll	1.50.1085.000140.05	140.05 KB (41,016 bytes)	12/7/1999 6:00:00 AM	Microsoft Corporation	c:\winnt\system32\wbem\wbemprox.dll
syssetup.dll	5.00.2189.1	494.77 KB (506,640 bytes)	12/7/1999 6:00:00 AM	Microsoft Corporation	c:\winnt\system32\syssetup.dll
storprop.dll	5.00.2161.1	34.77 KB (35,600 bytes)	11/14/2001 9:32:27 AM	Microsoft Corporation	c:\winnt\system32\storprop.dll
olepro32.dll	5.0.4512	160.27 KB (164,112 bytes)	12/7/1999 6:00:00 AM	Microsoft Corporation	c:\winnt\system32\olepro32.dll

Appendix C – Tunable Parameters

dmocx.dll	5.00.2134.1	23.27 KB (23,824 bytes)	12/7/1999 6:00:00 AM	Microsoft Corporation
	c:\winnt\system32\dmocx.dll			
mlang.dll	5.00.2920.0000	510.77 KB (523,024 bytes)	12/7/1999 6:00:00 AM	Microsoft Corporation
	c:\winnt\system32\mlang.dll			
rassapi.dll	5.00.2188.1	14.27 KB (14,608 bytes)	12/7/1999 6:00:00 AM	Microsoft Corporation
	c:\winnt\system32\rassapi.dll			
adsnt.dll	5.00.2191.1	194.27 KB (198,928 bytes)	12/7/1999 6:00:00 AM	Microsoft Corporation
	c:\winnt\system32\adsnt.dll			
dbghelp.dll	5.00.2195.1	159.27 KB (163,088 bytes)	12/7/1999 6:00:00 AM	Microsoft Corporation
	c:\winnt\system32\dbghelp.dll			
localesec.dll	5.00.2134.1	227.27 KB (232,720 bytes)	12/7/1999 6:00:00 AM	Microsoft Corporation
	c:\winnt\system32\localesec.dll			
devmgr.dll	5.00.2166.1	215.77 KB (220,944 bytes)	12/7/1999 6:00:00 AM	Microsoft Corporation
	c:\winnt\system32\devmgr.dll			
filemgmt.dll	5.00.2134.1	287.27 KB (294,160 bytes)	12/7/1999 6:00:00 AM	Microsoft Corporation
	c:\winnt\system32\filemgmt.dll			
pdh.dll	5.00.2174.1	143.27 KB (146,704 bytes)	12/7/1999 6:00:00 AM	Microsoft Corporation
	c:\winnt\system32\pdh.dll			
smlogcfg.dll	5.00.2163.1	273.27 KB (279,824 bytes)	12/7/1999 6:00:00 AM	Microsoft Corporation
	c:\winnt\system32\smlogcfg.dll			
cabinet.dll	5.00.2147.1	54.77 KB (56,080 bytes)	12/7/1999 6:00:00 AM	Microsoft Corporation
	c:\winnt\system32\cabinet.dll			
msinfo32.dll	5.00.2177.1	312.27 KB (319,760 bytes)	11/14/2001 3:46:19 PM	Microsoft Corporation
	c:\program files\common files\microsoft shared\msinfo\msinfo32.dll			
riched20.dll	5.30.23.1200	421.27 KB (431,376 bytes)	12/7/1999 6:00:00 AM	Microsoft Corporation
	c:\winnt\system32\riched20.dll			
riched32.dll	5.00.2134.1	3.77 KB (3,856 bytes)	12/7/1999 6:00:00 AM	Microsoft Corporation
	c:\winnt\system32\riched32.dll			
els.dll	5.00.2175.1	151.27 KB (154,896 bytes)	12/7/1999 6:00:00 AM	Microsoft Corporation
	c:\winnt\system32\els.dll			
ntsmmgr.dll	1,0,0,1	427.77 KB (438,032 bytes)	12/7/1999 6:00:00 AM	Microsoft Corporation and HighGround Systems, Inc.
	c:\winnt\system32\ntsmmgr.dll			
mmfutil.dll	1.50.1085.0000	32.06 KB (32,829 bytes)	12/7/1999 6:00:00 AM	Microsoft Corporation
	c:\winnt\system32\mmfutil.dll			
logdrive.dll	1.50.1085.0000	200.06 KB (204,863 bytes)	12/7/1999 6:00:00 AM	Microsoft Corporation
	c:\winnt\system32\logdrive.dll			
dfrgres.dll	5.00.2150.1	27.50 KB (28,160 bytes)	12/7/1999 6:00:00 AM	Executive Software International, Inc.
	c:\winnt\system32\dfrgres.dll			
dfrgsnap.dll	5.00.2150.1	41.77 KB (42,768 bytes)	12/7/1999 6:00:00 AM	Executive Software International, Inc.
	c:\winnt\system32\dfrgsnap.dll			
dmdskres.dll	2191.1.296.2	119.00 KB (121,856 bytes)	12/7/1999 6:00:00 AM	Microsoft Corp., VERITAS Software
	c:\winnt\system32\dmdskres.dll			
dmutil.dll	2191.1.296.2	41.77 KB (42,768 bytes)	12/7/1999 6:00:00 AM	VERITAS Software Corp.
	c:\winnt\system32\dmutil.dll			
ntmsapi.dll	5.00.1948.1	50.27 KB (51,472 bytes)	12/7/1999 6:00:00 AM	Microsoft Corporation
	c:\winnt\system32\ntmsapi.dll			
dmdskmgr.dll	2191.1.296.2	158.77 KB (162,576 bytes)	12/7/1999 6:00:00 AM	Microsoft Corp., VERITAS Software
	c:\winnt\system32\dmdskmgr.dll			
mycomput.dll	5.00.2134.1	107.77 KB (110,352 bytes)	12/7/1999 6:00:00 AM	Microsoft Corporation
	c:\winnt\system32\mycomput.dll			
comdlg32.dll	5.00.2920.0000	236.77 KB (242,448 bytes)	12/7/1999 6:00:00 AM	Microsoft Corporation
	c:\winnt\system32\comdlg32.dll			
mmcndmgr.dll	5.00.2178.1	815.27 KB (834,832 bytes)	12/7/1999 6:00:00 AM	Microsoft Corporation
	c:\winnt\system32\mmcndmgr.dll			

Appendix C – Tunable Parameters

mfc42u.dll	6.00.8665.0	972.05 KB (995,384 bytes)	12/7/1999 6:00:00 AM
	Microsoft Corporation	c:\winnt\system32\mfc42u.dll	
mmc.exe	5.00.2153.1	589.27 KB (603,408 bytes)	12/7/1999 6:00:00 AM
	Microsoft Corporation	c:\winnt\system32\mmc.exe	
ssmslpcn.dll	2000.080.0382.00	28.56 KB (29,244 bytes)	11/14/2001 4:15:18 PM
	Microsoft Corporation	c:\program files\microsoft sql server\mssql\binn\ssmslpcn.dll	
security.dll	5.00.2154.1	5.77 KB (5,904 bytes)	12/7/1999 6:00:00 AM
	Microsoft Corporation	c:\winnt\system32\security.dll	
ssnmpn70.dll	2000.080.0194.00	24.06 KB (24,638 bytes)	11/14/2001 4:15:18 PM
	Microsoft Corporation	c:\program files\microsoft sql server\mssql\binn\ssnmpn70.dll	
ssnetlib.dll	2000.080.0382.00	84.56 KB (86,588 bytes)	11/14/2001 4:15:18 PM
	Microsoft Corporation	c:\program files\microsoft sql server\mssql\binn\ssnetlib.dll	
sqllevn70.rll	2000.080.0194.00	28.00 KB (28,672 bytes)	11/14/2001 4:15:18 PM
	Microsoft Corporation	c:\program files\microsoft sql server\mssql\binn\resources\1033\sqllevn70.rll	
msvcirt.dll	6.10.8637.0	76.05 KB (77,878 bytes)	12/7/1999 6:00:00 AM
	Microsoft Corporation	c:\winnt\system32\msvcirt.dll	
sqlsort.dll	2000.080.0382.00	576.56 KB (590,396 bytes)	11/14/2001 4:15:18 PM
	Microsoft Corporation	c:\program files\microsoft sql server\mssql\binn\sqlsort.dll	
ums.dll	2000.080.0382.00	48.07 KB (49,228 bytes)	11/14/2001 4:15:18 PM
	Microsoft Corporation	c:\program files\microsoft sql server\mssql\binn\ums.dll	
opends60.dll	2000.080.0194.00	24.06 KB (24,639 bytes)	11/14/2001 4:15:18 PM
	Microsoft Corporation	c:\program files\microsoft sql server\mssql\binn\opends60.dll	
sqlservr.exe	2000.080.0384.00	7.05 MB (7,397,457 bytes)	11/14/2001 4:15:18 PM
	Microsoft Corporation	c:\program files\microsoft sql server\mssql\binn\sqlservr.exe	
cmd.exe	5.00.2144.1	230.77 KB (236,304 bytes)	12/7/1999 6:00:00 AM
	Microsoft Corporation	c:\winnt\system32\cmd.exe	
gamevlog.exe	Not Available	186.85 KB (191,330 bytes)	11/15/2001 11:01:30 AM
	Not Available	c:\winnt\system32\gamserv\gamevlog.exe	
gamevent.exe	Not Available	88.71 KB (90,834 bytes)	11/15/2001 11:01:30 AM
	Not Available	c:\winnt\system32\gamserv\gamevent.exe	
gamserv.exe	Not Available	127.20 KB (130,257 bytes)	11/15/2001 11:01:31 AM
	Not Available	c:\winnt\system32\gamserv\gamserv.exe	
gamscm.exe	Not Available	119.28 KB (122,144 bytes)	11/15/2001 11:01:30 AM
	Not Available	c:\winnt\system32\gamserv\gamscm.exe	
wininet.dll	5.00.2920.0000456.77	KB (467,728 bytes)	12/7/1999 6:00:00 AM
	Microsoft Corporation	c:\winnt\system32\wininet.dll	
urlmon.dll	5.00.2920.0000426.77	KB (437,008 bytes)	12/7/1999 6:00:00 AM
	Microsoft Corporation	c:\winnt\system32\urlmon.dll	
faxshell.dll	5.00.2134.1	8.27 KB (8,464 bytes)	12/7/1999 6:00:00 AM
	Microsoft Corporation	c:\winnt\system32\faxshell.dll	
msacm32.dll	5.00.2134.1	65.27 KB (66,832 bytes)	12/7/1999 6:00:00 AM
	Microsoft Corporation	c:\winnt\system32\msacm32.dll	
avifil32.dll	5.00.2134.1	76.27 KB (78,096 bytes)	12/7/1999 6:00:00 AM
	Microsoft Corporation	c:\winnt\system32\avifil32.dll	
msvfw32.dll	5.00.2134.1	113.77 KB (116,496 bytes)	12/7/1999 6:00:00 AM
	Microsoft Corporation	c:\winnt\system32\msvfw32.dll	
docprop2.dll	5.00.2178.1	297.77 KB (304,912 bytes)	12/7/1999 6:00:00 AM
	Microsoft Corporation	c:\winnt\system32\docprop2.dll	
linkinfo.dll	5.00.2134.1	15.77 KB (16,144 bytes)	12/7/1999 6:00:00 AM
	Microsoft Corporation	c:\winnt\system32\linkinfo.dll	
browselc.dll	5.00.2920.000034.50	KB (35,328 bytes)	12/7/1999 6:00:00 AM
	Microsoft Corporation	c:\winnt\system32\browselc.dll	
ntshruil.dll	5.00.2134.1	46.77 KB (47,888 bytes)	12/7/1999 6:00:00 AM
	Microsoft Corporation	c:\winnt\system32\ntshruil.dll	

Appendix C – Tunable Parameters

msi.dll	1.10.1029.0	1.71 MB (1,794,320 bytes)	12/7/1999 6:00:00 AM	Microsoft Corporation	c:\winnt\system32\msi.dll
powrprof.dll	5.00.2920.0000	13.27 KB (13,584 bytes)	12/7/1999 6:00:00 AM	Microsoft Corporation	c:\winnt\system32\powrprof.dll
batmeter.dll	5.00.2920.0000	20.27 KB (20,752 bytes)	12/7/1999 6:00:00 AM	Microsoft Corporation	c:\winnt\system32\batmeter.dll
stobject.dll	5.00.2144.1	81.77 KB (83,728 bytes)	12/7/1999 6:00:00 AM	Microsoft Corporation	c:\winnt\system32\stobject.dll
webcheck.dll	5.00.2920.0000	251.77 KB (257,808 bytes)	12/7/1999 6:00:00 AM	Microsoft Corporation	c:\winnt\system32\webcheck.dll
browseui.dll	5.00.2920.0000	793.27 KB (812,304 bytes)	12/7/1999 6:00:00 AM	Microsoft Corporation	c:\winnt\system32\browseui.dll
shdocvw.dll	5.00.2920.0000	1.05 MB (1,104,144 bytes)	12/7/1999 6:00:00 AM	Microsoft Corporation	c:\winnt\system32\shdocvw.dll
explorer.exe	5.00.2920.0000	232.77 KB (238,352 bytes)	12/7/1999 6:00:00 AM	Microsoft Corporation	c:\winnt\explorer.exe
netui1.dll	5.00.2134.1	210.27 KB (215,312 bytes)	12/7/1999 6:00:00 AM	Microsoft Corporation	c:\winnt\system32\netui1.dll
netui0.dll	5.00.2134.1	70.27 KB (71,952 bytes)	12/7/1999 6:00:00 AM	Microsoft Corporation	c:\winnt\system32\netui0.dll
ntlanman.dll	5.00.2157.1	35.27 KB (36,112 bytes)	12/7/1999 6:00:00 AM	Microsoft Corporation	c:\winnt\system32\ntlanman.dll
wshnetbs.dll	5.00.2134.1	7.77 KB (7,952 bytes)	12/7/1999 6:00:00 AM	Microsoft Corporation	c:\winnt\system32\wshnetbs.dll
rapilib.dll	5.00.2167.1	25.27 KB (25,872 bytes)	12/7/1999 6:00:00 AM	Microsoft Corporation	c:\winnt\system32\rapilib.dll
rsvsp.dll	5.00.2167.1	74.77 KB (76,560 bytes)	12/7/1999 6:00:00 AM	Microsoft Corporation	c:\winnt\system32\rsvsp.dll
provthrd.dll	1.50.1085.0000	68.07 KB (69,708 bytes)	11/14/2001 3:46:08 PM	Microsoft Corporation	c:\winnt\system32\wbem\provthrd.dll
ntevt.dll	1.50.1085.0000	192.06 KB (196,669 bytes)	12/7/1999 6:00:00 AM	Microsoft Corporation	c:\winnt\system32\wbem\ntevt.dll
perfos.dll	5.00.2155.1	21.27 KB (21,776 bytes)	12/7/1999 6:00:00 AM	Microsoft Corporation	c:\winnt\system32\perfos.dll
psapi.dll	5.00.2134.1	28.27 KB (28,944 bytes)	12/7/1999 6:00:00 AM	Microsoft Corporation	c:\winnt\system32\psapi.dll
framedyn.dll	1.50.1085.0000	164.05 KB (167,992 bytes)	12/7/1999 6:00:00 AM	Microsoft Corporation	c:\winnt\system32\wbem\framedyn.dll
cimwin32.dll	1.50.1085.0000	1.03 MB (1,077,306 bytes)	12/7/1999 6:00:00 AM	Microsoft Corporation	c:\winnt\system32\wbem\cimwin32.dll
wbemsvc.dll	1.50.1085.0000	140.07 KB (143,430 bytes)	12/7/1999 6:00:00 AM	Microsoft Corporation	c:\winnt\system32\wbem\wbemsvc.dll
wbemess.dll	1.50.1085.0001	135.05 KB (360,503 bytes)	12/7/1999 6:00:00 AM	Microsoft Corporation	c:\winnt\system32\wbem\wbemess.dll
fastprox.dll	1.50.1085.0001	144.08 KB (147,534 bytes)	12/7/1999 6:00:00 AM	Microsoft Corporation	c:\winnt\system32\wbem\fastprox.dll
wbemcore.dll	1.50.1085.0001	163.05 KB (647,224 bytes)	12/7/1999 6:00:00 AM	Microsoft Corporation	c:\winnt\system32\wbem\wbemcore.dll
wbemcomn.dll	1.50.1085.0001	168.05 KB (700,472 bytes)	12/7/1999 6:00:00 AM	Microsoft Corporation	c:\winnt\system32\wbem\wbemcomn.dll
winmgmt.exe	1.50.1085.0001	188.05 KB (192,567 bytes)	12/7/1999 6:00:00 AM	Microsoft Corporation	c:\winnt\system32\wbem\winmgmt.exe
ntmarta.dll	5.00.2158.1	98.77 KB (101,136 bytes)	12/7/1999 6:00:00 AM	Microsoft Corporation	c:\winnt\system32\ntmarta.dll

Appendix C – Tunable Parameters

tapisrv.dll	5.00.2186.1	168.77 KB (172,816 bytes)	12/7/1999 6:00:00 AM
Microsoft Corporation c:\winnt\system32\tapisrv.dll			
rasdlg.dll	5.00.2194.1	514.27 KB (526,608 bytes)	12/7/1999 6:00:00 AM
Microsoft Corporation c:\winnt\system32\rasdlg.dll			
netcfgx.dll	5.00.2175.1	533.77 KB (546,576 bytes)	12/7/1999 6:00:00 AM
Microsoft Corporation c:\winnt\system32\netcfgx.dll			
sens.dll	5.00.2163.1	36.77 KB (37,648 bytes)	12/7/1999 6:00:00 AM
Microsoft Corporation c:\winnt\system32\sens.dll			
rasmans.dll	5.00.2188.1	146.77 KB (150,288 bytes)	12/7/1999 6:00:00 AM
Microsoft Corporation c:\winnt\system32\rasmans.dll			
wmi.dll	5.00.2191.1	6.27 KB (6,416 bytes)	12/7/1999 6:00:00 AM
Microsoft Corporation c:\winnt\system32\wmi.dll			
netshell.dll	5.00.2176.1	456.77 KB (467,728 bytes)	12/7/1999 6:00:00 AM
Microsoft Corporation c:\winnt\system32\netshell.dll			
netman.dll	5.00.2175.1	88.77 KB (90,896 bytes)	12/7/1999 6:00:00 AM
Microsoft Corporation c:\winnt\system32\netman.dll			
es.dll	1999.9.3422.21231.77	KB (237,328 bytes)	12/7/1999 6:00:00 AM
Microsoft Corporation c:\winnt\system32\es.dll			
mtxoci.dll	1999.9.3421.3	109.27 KB (111,888 bytes)	11/14/2001 9:43:35 AM
Microsoft Corporation c:\winnt\system32\mtxoci.dll			
resutils.dll	5.00.2191.1	39.77 KB (40,720 bytes)	12/7/1999 6:00:00 AM
Microsoft Corporation c:\winnt\system32\resutils.dll			
clusapi.dll	5.00.2179.1	50.27 KB (51,472 bytes)	12/7/1999 6:00:00 AM
Microsoft Corporation c:\winnt\system32\clusapi.dll			
msvcp50.dll	5.00.7051	552.50 KB (565,760 bytes)	12/7/1999 6:00:00 AM
Microsoft Corporation c:\winnt\system32\msvcp50.dll			
xolehlp.dll	1999.9.3421.3	17.27 KB (17,680 bytes)	11/14/2001 9:43:34 AM
Microsoft Corporation c:\winnt\system32\xolehlp.dll			
msdtclog.dll	1999.9.3421.3	89.77 KB (91,920 bytes)	11/14/2001 9:43:33 AM
Microsoft Corporation c:\winnt\system32\msdtclog.dll			
mtxclu.dll	1999.9.3421.3	50.27 KB (51,472 bytes)	12/7/1999 6:00:00 AM
Microsoft Corporation c:\winnt\system32\mtxclu.dll			
msdtcprx.dll	1999.9.3422.10619.27	KB (634,128 bytes)	11/14/2001 9:43:35 AM
Microsoft Corporation c:\winnt\system32\msdtcprx.dll			
txfaux.dll	1999.9.3422.24341.27	KB (349,456 bytes)	11/14/2001 9:43:33 AM
Microsoft Corporation c:\winnt\system32\txfaux.dll			
msdtctm.dll	1999.9.3422.121.02	MB (1,070,864 bytes)	11/14/2001 9:43:34 AM
Microsoft Corporation c:\winnt\system32\msdtctm.dll			
msdtc.exe	1999.9.3421.3	6.77 KB (6,928 bytes)	11/14/2001 9:43:33 AM
Microsoft Corporation c:\winnt\system32\msdtc.exe			
rasadhlp.dll	5.00.2168.1	7.27 KB (7,440 bytes)	12/7/1999 6:00:00 AM
Microsoft Corporation c:\winnt\system32\rasadhlp.dll			
winnr.dll	5.00.2160.1	18.77 KB (19,216 bytes)	12/7/1999 6:00:00 AM
Microsoft Corporation c:\winnt\system32\winnr.dll			
wshtcpip.dll	5.00.2134.1	17.27 KB (17,680 bytes)	12/7/1999 6:00:00 AM
Microsoft Corporation c:\winnt\system32\wshtcpip.dll			
msafd.dll	5.00.2153.1	54.27 KB (55,568 bytes)	12/7/1999 6:00:00 AM
Microsoft Corporation c:\winnt\system32\msafd.dll			
rpcss.dll	5.00.2181.1	229.27 KB (234,768 bytes)	12/7/1999 6:00:00 AM
Microsoft Corporation c:\winnt\system32\rpcss.dll			
svchost.exe	5.00.2134.1	7.77 KB (7,952 bytes)	12/7/1999 6:00:00 AM
Microsoft Corporation c:\winnt\system32\svchost.exe			
scecli.dll	5.00.2191.1	105.27 KB (107,792 bytes)	12/7/1999 6:00:00 AM
Microsoft Corporation c:\winnt\system32\scecli.dll			

Appendix C – Tunable Parameters

atl.dll	3.00.8449	57.56 KB (58,938 bytes)	12/7/1999 6:00:00 AM	Microsoft Corporation
		c:\winnt\system32\atl.dll		
certcli.dll	5.00.2175.1	132.27 KB (135,440 bytes)	12/7/1999 6:00:00 AM	Microsoft Corporation
		c:\winnt\system32\certcli.dll		
esent.dll	6.0.3939.6	1.07 MB (1,120,016 bytes)	12/7/1999 6:00:00 AM	Microsoft Corporation
		c:\winnt\system32\esent.dll		
mswsock.dll	5.00.2152.1	62.27 KB (63,760 bytes)	12/7/1999 6:00:00 AM	Microsoft Corporation
		c:\winnt\system32\mswsock.dll		
ntdsatq.dll	5.00.2181.1	31.27 KB (32,016 bytes)	12/7/1999 6:00:00 AM	Microsoft Corporation
		c:\winnt\system32\ntdsatq.dll		
ntdsa.dll	5.00.2195.1	993.27 KB (1,017,104 bytes)	12/7/1999 6:00:00 AM	Microsoft Corporation
		c:\winnt\system32\ntdsa.dll		
kdcsvc.dll	5.00.2181.1	133.77 KB (136,976 bytes)	12/7/1999 6:00:00 AM	Microsoft Corporation
		c:\winnt\system32\kdcsvc.dll		
sfmapi.dll	5.00.2134.1	38.77 KB (39,696 bytes)	12/7/1999 6:00:00 AM	Microsoft Corporation
		c:\winnt\system32\sfmapi.dll		
rassfm.dll	5.00.2168.1	21.27 KB (21,776 bytes)	12/7/1999 6:00:00 AM	Microsoft Corporation
		c:\winnt\system32\rassfm.dll		
mpr.dll	5.00.2146.1	53.27 KB (54,544 bytes)	12/7/1999 6:00:00 AM	Microsoft Corporation
		c:\winnt\system32\mpr.dll		
schannel.dll	5.00.2170.1	139.77 KB (143,120 bytes)	12/7/1999 6:00:00 AM	Microsoft Corporation
		c:\winnt\system32\schannel.dll		
netlogon.dll	5.00.2182.1	347.77 KB (356,112 bytes)	12/7/1999 6:00:00 AM	Microsoft Corporation
		c:\winnt\system32\netlogon.dll		
msv1_0.dll	5.00.2164.1	94.77 KB (97,040 bytes)	12/7/1999 6:00:00 AM	Microsoft Corporation
		c:\winnt\system32\msv1_0.dll		
kerberos.dll	5.00.2181.1	196.77 KB (201,488 bytes)	12/7/1999 6:00:00 AM	Microsoft Corporation
		c:\winnt\system32\kerberos.dll		
msprivs.dll	5.00.2154.1	41.50 KB (42,496 bytes)	12/7/1999 6:00:00 AM	Microsoft Corporation
		c:\winnt\system32\msprivs.dll		
samsrv.dll	5.00.2192.1	357.77 KB (366,352 bytes)	12/7/1999 6:00:00 AM	Microsoft Corporation
		c:\winnt\system32\samsrv.dll		
lsasrv.dll	5.00.2184.1	487.77 KB (499,472 bytes)	12/7/1999 6:00:00 AM	Microsoft Corporation
		c:\winnt\system32\lsasrv.dll		
lsass.exe	5.00.2184.1	32.77 KB (33,552 bytes)	12/7/1999 6:00:00 AM	Microsoft Corporation
		c:\winnt\system32\lsass.exe		
dhcpcsvc.dll	5.00.2153.1	88.77 KB (90,896 bytes)	12/7/1999 6:00:00 AM	Microsoft Corporation
		c:\winnt\system32\dhcpcsvc.dll		
tapi32.dll	5.00.2182.1	123.27 KB (126,224 bytes)	12/7/1999 6:00:00 AM	Microsoft Corporation
		c:\winnt\system32\tapi32.dll		
rasman.dll	5.00.2188.1	54.77 KB (56,080 bytes)	12/7/1999 6:00:00 AM	Microsoft Corporation
		c:\winnt\system32\rasman.dll		
rasapi32.dll	5.00.2188.1	189.77 KB (194,320 bytes)	12/7/1999 6:00:00 AM	Microsoft Corporation
		c:\winnt\system32\rasapi32.dll		
rtutils.dll	5.00.2168.1	43.77 KB (44,816 bytes)	12/7/1999 6:00:00 AM	Microsoft Corporation
		c:\winnt\system32\rtutils.dll		
adslrpc.dll	5.00.2172.1	127.77 KB (130,832 bytes)	12/7/1999 6:00:00 AM	Microsoft Corporation
		c:\winnt\system32\adslrpc.dll		
activeds.dll	5.00.2172.1	172.77 KB (176,912 bytes)	12/7/1999 6:00:00 AM	Microsoft Corporation
		c:\winnt\system32\activeds.dll		
mprapi.dll	5.00.2181.1	79.27 KB (81,168 bytes)	12/7/1999 6:00:00 AM	Microsoft Corporation
		c:\winnt\system32\mprapi.dll		
iphlpapi.dll	5.00.2173.2	67.77 KB (69,392 bytes)	12/7/1999 6:00:00 AM	Microsoft Corporation
		c:\winnt\system32\iphlpapi.dll		

Appendix C – Tunable Parameters

rn20.dll	5.00.2152.1	35.77 KB (36,624 bytes)	12/7/1999 6:00:00 AM	Microsoft Corporation	c:\winnt\system32\rn20.dll
psbase.dll	5.00.2146.1	111.77 KB (114,448 bytes)	12/7/1999 6:00:00 AM	Microsoft Corporation	c:\winnt\system32\psbase.dll
wmicore.dll	5.00.2178.1	70.77 KB (72,464 bytes)	12/7/1999 6:00:00 AM	Microsoft Corporation	c:\winnt\system32\wmicore.dll
cryptsvc.dll	5.00.2181.1	61.77 KB (63,248 bytes)	12/7/1999 6:00:00 AM	Microsoft Corporation	c:\winnt\system32\cryptsvc.dll
cryptdll.dll	5.00.2135.1	41.27 KB (42,256 bytes)	12/7/1999 6:00:00 AM	Microsoft Corporation	c:\winnt\system32\cryptdll.dll
wkssvc.dll	5.00.2181.1	95.27 KB (97,552 bytes)	12/7/1999 6:00:00 AM	Microsoft Corporation	c:\winnt\system32\wkssvc.dll
srvsvc.dll	5.00.2178.1	79.27 KB (81,168 bytes)	12/7/1999 6:00:00 AM	Microsoft Corporation	c:\winnt\system32\srvsvc.dll
cfgmgr32.dll	5.00.2134.1	16.77 KB (17,168 bytes)	12/7/1999 6:00:00 AM	Microsoft Corporation	c:\winnt\system32\cfgmgr32.dll
dmserver.dll	2191.1.296.2	11.77 KB (12,048 bytes)	12/7/1999 6:00:00 AM	VERITAS Software Corp.	c:\winnt\system32\dmserver.dll
winsta.dll	5.00.2134.1	36.27 KB (37,136 bytes)	12/7/1999 6:00:00 AM	Microsoft Corporation	c:\winnt\system32\winsta.dll
icmp.dll	5.00.2134.1	7.27 KB (7,440 bytes)	12/7/1999 6:00:00 AM	Microsoft Corporation	c:\winnt\system32\icmp.dll
lmhsvc.dll	5.00.2134.1	9.27 KB (9,488 bytes)	12/7/1999 6:00:00 AM	Microsoft Corporation	c:\winnt\system32\lmhsvc.dll
eventlog.dll	5.00.2178.1	43.77 KB (44,816 bytes)	12/7/1999 6:00:00 AM	Microsoft Corporation	c:\winnt\system32\eventlog.dll
ntdsapi.dll	5.00.2160.1	56.27 KB (57,616 bytes)	12/7/1999 6:00:00 AM	Microsoft Corporation	c:\winnt\system32\ntdsapi.dll
scesrv.dll	5.00.2188.1	225.77 KB (231,184 bytes)	12/7/1999 6:00:00 AM	Microsoft Corporation	c:\winnt\system32\scesrv.dll
umpnpgm.dll	5.00.2182.1	86.27 KB (88,336 bytes)	12/7/1999 6:00:00 AM	Microsoft Corporation	c:\winnt\system32\umpnpgm.dll
services.exe	5.00.2134.1	86.77 KB (88,848 bytes)	12/7/1999 6:00:00 AM	Microsoft Corporation	c:\winnt\system32\services.exe
clbcatq.dll	1999.9.3422.1	14479.27 KB (490,768 bytes)	11/14/2001 9:43:24 AM	Microsoft Corporation	c:\winnt\system32\clbcatq.dll
oleaut32.dll	2.40.4512	600.27 KB (614,672 bytes)	12/7/1999 6:00:00 AM	Microsoft Corporation	c:\winnt\system32\oleaut32.dll
cscui.dll	5.00.2172.1	227.27 KB (232,720 bytes)	12/7/1999 6:00:00 AM	Microsoft Corporation	c:\winnt\system32\cscui.dll
winspool.drv	5.00.2167.1	109.77 KB (112,400 bytes)	12/7/1999 6:00:00 AM	Microsoft Corporation	c:\winnt\system32\winspool.drv
winscard.dll	5.00.2134.1	77.27 KB (79,120 bytes)	12/7/1999 6:00:00 AM	Microsoft Corporation	c:\winnt\system32\winscard.dll
wlnotify.dll	5.00.2164.1	53.27 KB (54,544 bytes)	12/7/1999 6:00:00 AM	Microsoft Corporation	c:\winnt\system32\wlnotify.dll
cscdll.dll	5.00.2189.1	98.27 KB (100,624 bytes)	12/7/1999 6:00:00 AM	Microsoft Corporation	c:\winnt\system32\cscdll.dll
lz32.dll	5.00.2134.1	9.77 KB (10,000 bytes)	12/7/1999 6:00:00 AM	Microsoft Corporation	c:\winnt\system32\lz32.dll
version.dll	5.00.2134.1	15.77 KB (16,144 bytes)	12/7/1999 6:00:00 AM	Microsoft Corporation	c:\winnt\system32\version.dll
rsabase.dll	5.00.2150.1	128.77 KB (131,856 bytes)	12/7/1999 6:00:00 AM	Microsoft Corporation	c:\winnt\system32\rsabase.dll

Appendix C – Tunable Parameters

mscat32.dll	5.131.2134.1	7.77 KB (7,952 bytes)	12/7/1999 6:00:00 AM	Microsoft Corporation	c:\winnt\system32\mscat32.dll
ole32.dll	5.00.2181.1	966.27 KB (989,456 bytes)	12/7/1999 6:00:00 AM	Microsoft Corporation	c:\winnt\system32\ole32.dll
imagehlp.dll	5.00.2195.1	125.27 KB (128,272 bytes)	12/7/1999 6:00:00 AM	Microsoft Corporation	c:\winnt\system32\imagehlp.dll
msasn1.dll	5.00.2134.1	51.27 KB (52,496 bytes)	12/7/1999 6:00:00 AM	Microsoft Corporation	c:\winnt\system32\msasn1.dll
crypt32.dll	5.131.2173.1	465.77 KB (476,944 bytes)	12/7/1999 6:00:00 AM	Microsoft Corporation	c:\winnt\system32\crypt32.dll
wintrust.dll	5.131.2143.1	162.27 KB (166,160 bytes)	12/7/1999 6:00:00 AM	Microsoft Corporation	c:\winnt\system32\wintrust.dll
setupapi.dll	5.00.2183.1	554.27 KB (567,568 bytes)	12/7/1999 6:00:00 AM	Microsoft Corporation	c:\winnt\system32\setupapi.dll
winmm.dll	5.00.2161.1	184.77 KB (189,200 bytes)	12/7/1999 6:00:00 AM	Microsoft Corporation	c:\winnt\system32\winmm.dll
comctl32.dll	5.81	540.27 KB (553,232 bytes)	12/7/1999 6:00:00 AM	Microsoft Corporation	c:\winnt\system32\comctl32.dll
shlwapi.dll	5.00.2920.0000	282.77 KB (289,552 bytes)	12/7/1999 6:00:00 AM	Microsoft Corporation	c:\winnt\system32\shlwapi.dll
shell32.dll	5.00.2920.0000	2.24 MB (2,352,400 bytes)	12/7/1999 6:00:00 AM	Microsoft Corporation	c:\winnt\system32\shell32.dll
msgina.dll	5.00.2191.1	309.77 KB (317,200 bytes)	12/7/1999 6:00:00 AM	Microsoft Corporation	c:\winnt\system32\msgina.dll
wsock32.dll	5.00.2152.1	21.27 KB (21,776 bytes)	12/7/1999 6:00:00 AM	Microsoft Corporation	c:\winnt\system32\wsock32.dll
dnsapi.dll	5.00.2181.1	129.77 KB (132,880 bytes)	12/7/1999 6:00:00 AM	Microsoft Corporation	c:\winnt\system32\dnsapi.dll
wldap32.dll	5.00.2168.1	155.77 KB (159,504 bytes)	12/7/1999 6:00:00 AM	Microsoft Corporation	c:\winnt\system32\wldap32.dll
ws2help.dll	5.00.2134.1	17.77 KB (18,192 bytes)	12/7/1999 6:00:00 AM	Microsoft Corporation	c:\winnt\system32\ws2help.dll
ws2_32.dll	5.00.2134.1	69.77 KB (71,440 bytes)	12/7/1999 6:00:00 AM	Microsoft Corporation	c:\winnt\system32\ws2_32.dll
samlib.dll	5.00.2160.1	46.27 KB (47,376 bytes)	12/7/1999 6:00:00 AM	Microsoft Corporation	c:\winnt\system32\samlib.dll
netrap.dll	5.00.2134.1	11.27 KB (11,536 bytes)	12/7/1999 6:00:00 AM	Microsoft Corporation	c:\winnt\system32\netrap.dll
netapi32.dll	5.00.2194.1	302.77 KB (310,032 bytes)	12/7/1999 6:00:00 AM	Microsoft Corporation	c:\winnt\system32\netapi32.dll
profmap.dll	5.00.2181.1	29.27 KB (29,968 bytes)	12/7/1999 6:00:00 AM	Microsoft Corporation	c:\winnt\system32\profmap.dll
secur32.dll	5.00.2154.1	46.77 KB (47,888 bytes)	12/7/1999 6:00:00 AM	Microsoft Corporation	c:\winnt\system32\secur32.dll
sfc.dll	5.00.2164.1	84.27 KB (86,288 bytes)	12/7/1999 6:00:00 AM	Microsoft Corporation	c:\winnt\system32\sfc.dll
nddeapi.dll	5.00.2137.1	15.27 KB (15,632 bytes)	12/7/1999 6:00:00 AM	Microsoft Corporation	c:\winnt\system32\nddeapi.dll
userenv.dll	5.00.2185.1	361.27 KB (369,936 bytes)	12/7/1999 6:00:00 AM	Microsoft Corporation	c:\winnt\system32\userenv.dll
user32.dll	5.00.2180.1	393.27 KB (402,704 bytes)	12/7/1999 6:00:00 AM	Microsoft Corporation	c:\winnt\system32\user32.dll
gdi32.dll	5.00.2180.1	228.77 KB (234,256 bytes)	12/7/1999 6:00:00 AM	Microsoft Corporation	c:\winnt\system32\gdi32.dll

Appendix C – Tunable Parameters

rpctr4.dll	5.00.2193.1	434.27 KB (444,688 bytes)	12/7/1999 6:00:00 AM
Microsoft Corporation c:\winnt\system32\rpctr4.dll			
advapi32.dll	5.00.2191.1	349.27 KB (357,648 bytes)	12/7/1999 6:00:00 AM
Microsoft Corporation c:\winnt\system32\advapi32.dll			
kernel32.dll	5.00.2191.1	715.27 KB (732,432 bytes)	12/7/1999 6:00:00 AM
Microsoft Corporation c:\winnt\system32\kernel32.dll			
msvcrt.dll	6.10.8637.0	288.09 KB (295,000 bytes)	12/7/1999 6:00:00 AM
Microsoft Corporation c:\winnt\system32\msvcrt.dll			
winlogon.exe	5.00.2182.1	173.27 KB (177,424 bytes)	12/7/1999 6:00:00 AM
Microsoft Corporation c:\winnt\system32\winlogon.exe			
sfcfiles.dll	5.00.2195.1	973.27 KB (996,624 bytes)	12/7/1999 6:00:00 AM
Microsoft Corporation c:\winnt\system32\sfcfiles.dll			
ntdll.dll	5.00.2163.1	469.77 KB (481,040 bytes)	12/7/1999 6:00:00 AM
Microsoft Corporation c:\winnt\system32\ntdll.dll			
smss.exe	5.00.2170.1	44.27 KB (45,328 bytes)	12/7/1999 6:00:00 AM
Microsoft Corporation c:\winnt\system32\smss.exe			

[Services]

Display Name	Name	State	Start Mode	Service Type	Path	Error Control	Start Name	Tag ID
Alerter	Alerter	Stopped	Manual	Share Process	c:\winnt\system32\services.exe	Normal	LocalSystem	0
Application Management			AppMgmt	Stopped	Manual Share Process			
	c:\winnt\system32\services.exe			Normal	LocalSystem	0		
Computer Browser	Browser	Stopped	Manual	Share Process				
	c:\winnt\system32\services.exe			Normal	LocalSystem	0		
Indexing Service	cisvc	Stopped	Manual	Share Process				
	c:\winnt\system32\cisvc.exe			Normal	LocalSystem	0		
ClipBook	ClipSrv	Stopped	Manual	Own Process	c:\winnt\system32\clipsrv.exe			
		Normal	LocalSystem	0				
Distributed File System	Dfs	Stopped	Manual	Own Process				
	c:\winnt\system32\dfssvc.exe			Normal	LocalSystem	0		
DHCP Client	Dhcp	Stopped	Manual	Share Process	c:\winnt\system32\services.exe			
		Normal	LocalSystem	0				
Logical Disk Manager	Administrative Service		dmdadmin	Stopped	Manual Share			
Process	c:\winnt\system32\dmdadmin.exe	/com	Normal	LocalSystem	0			
Logical Disk Manager	dmserver	Running	Auto	Share Process				
	c:\winnt\system32\services.exe			Normal	LocalSystem	0		
DNS Client	Dnscache	Stopped	Manual	Share Process				
	c:\winnt\system32\services.exe			Normal	LocalSystem	0		
Event Log	Eventlog	Running	Auto	Share Process				
	c:\winnt\system32\services.exe			Normal	LocalSystem	0		
COM+ Event System	EventSystem	Running	Auto	Share Process				
	c:\winnt\system32\svchost.exe	-k netsvcs	Normal	LocalSystem	0			
Fax Service	Fax	Stopped	Manual	Own Process	c:\winnt\system32\faxsvc.exe			
		Normal	LocalSystem	0				
Mylex Global Array Manager	Server		gamscom	Running	Manual Own Process			
	c:\winnt\system32\gamserver\gamscom.exe			Normal	LocalSystem	0		
Intersite Messaging	IsmServ	Stopped	Disabled	Own Process				
	c:\winnt\system32\ismserv.exe			Normal	LocalSystem	0		
Kerberos Key Distribution Center	kdc	Stopped	Disabled	Share Process				
	c:\winnt\system32\lsass.exe			Normal	LocalSystem	0		
Server	lanmanserver	Running	Auto	Share Process	c:\winnt\system32\services.exe			
		Normal	LocalSystem	0				

Appendix C – Tunable Parameters

Workstation	lanmanworkstation	Running	Auto	Share Process
	c:\winnt\system32\services.exe	Normal	LocalSystem	0
License Logging Service	LicenseService	Stopped		Manual Own Process
	c:\winnt\system32\llssrv.exe	Normal	LocalSystem	0
TCP/IP NetBIOS Helper Service	LmHosts	Running	Auto	Share Process
	c:\winnt\system32\services.exe	Normal	LocalSystem	0
Messenger	Messenger	Stopped	Manual	Share Process
	c:\winnt\system32\services.exe	Normal	LocalSystem	0
NetMeeting Remote Desktop Sharing	mnmsrvc	Stopped		Manual Own Process
	c:\winnt\system32\mnmsrvc.exe	Normal	LocalSystem	0
Distributed Transaction Coordinator	MSDTC	Running	Auto	Own Process
	c:\winnt\system32\msdtc.exe	Normal	LocalSystem	0
Windows Installer	MSIServer	Stopped	Manual	Share Process
	c:\winnt\system32\msiexec.exe /v	Normal	LocalSystem	0
MSSQLSERVER	MSSQLSERVER	Stopped		Manual Own Process
	c:\progra~1\micros~2\mssql\binn\sqlservr.exe	Normal	LocalSystem	0
MSSQLServerADHelper	MSSQLServerADHelper	Stopped		Manual Own Process
	c:\program files\microsoft sql server\80\tools\binn\sqladhlp.exe	Normal	LocalSystem	0
Network DDE	NetDDE	Stopped	Manual	Share Process
	c:\winnt\system32\netdde.exe	Normal	LocalSystem	0
Network DDE DSDM	NetDDEdsdm	Stopped		Manual Share Process
	c:\winnt\system32\netdde.exe	Normal	LocalSystem	0
Net Logon	Netlogon	Stopped	Manual	Share Process
	c:\winnt\system32\lsass.exe	Normal	LocalSystem	0
Network Connections	Netman	Running	Auto	Share Process
	c:\winnt\system32\svchost.exe -k netsvcs	Normal	LocalSystem	0
File Replication	NtFrs	Stopped	Manual	Own Process
	Ignore	LocalSystem	0	c:\winnt\system32\ntfrs.exe
NT LM Security Support Provider	NtLmSsp	Stopped		Manual Share Process
	c:\winnt\system32\lsass.exe	Normal	LocalSystem	0
Removable Storage	NtmsSvc	Stopped	Manual	Share Process
	c:\winnt\system32\svchost.exe -k netsvcs	Normal	LocalSystem	0
Plug and Play	PlugPlay	Running	Auto	Share Process
	c:\winnt\system32\services.exe	Normal	LocalSystem	0
IPSEC Policy Agent	PolicyAgent	Stopped	Manual	Share Process
	c:\winnt\system32\lsass.exe	Normal	LocalSystem	0
Protected Storage	ProtectedStorage	Running	Auto	Share Process
	c:\winnt\system32\services.exe	Normal	LocalSystem	0
Remote Access Auto Connection Manager	RasAuto	Stopped		Manual Share Process
	c:\winnt\system32\svchost.exe -k netsvcs	Normal	LocalSystem	0
Remote Access Connection Manager	RasMan	Stopped		Manual Share Process
	c:\winnt\system32\svchost.exe -k netsvcs	Normal	LocalSystem	0
Routing and Remote Access	RemoteAccess	Stopped	Disabled	Share Process
	c:\winnt\system32\svchost.exe -k netsvcs	Normal	LocalSystem	0
Remote Registry Service	RemoteRegistry	Stopped		Manual Own Process
	c:\winnt\system32\regsvc.exe	Normal	LocalSystem	0
Remote Procedure Call (RPC) Locator	RpcLocator	Stopped		Manual Own Process
	c:\winnt\system32\locator.exe	Normal	LocalSystem	0
Remote Procedure Call (RPC)	RpcSs	Running	Auto	Share Process
	c:\winnt\system32\svchost -k rpcss	Normal	LocalSystem	0
QoS RSVP	RSVP	Running	Manual	Own Process
	Normal	LocalSystem	0	c:\winnt\system32\rsvp.exe -s
Security Accounts Manager	SamSs	Running	Auto	Share Process
	c:\winnt\system32\lsass.exe	Normal	LocalSystem	0

Appendix C – Tunable Parameters

Smart Card Helper	SCardDrv	Stopped	Manual Share Process	
	c:\winnt\system32\scardsvr.exe	Ignore	LocalSystem	0
Smart Card	SCardSvr	Stopped	Manual Share Process	
	c:\winnt\system32\scardsvr.exe	Ignore	LocalSystem	0
Task Scheduler	Schedule	Stopped	Manual Share Process	
	c:\winnt\system32\mstask.exe	Normal	LocalSystem	0
RunAs Service	seclogon	Stopped	Manual Share Process	
	c:\winnt\system32\services.exe	Ignore	LocalSystem	0
System Event Notification	SENS	Stopped	Manual Share Process	
	c:\winnt\system32\svchost.exe -k netsvcs	Normal	LocalSystem	0
Internet Connection Sharing	SharedAccess	Stopped	Manual Share Process	
	c:\winnt\system32\svchost.exe -k netsvcs	Normal	LocalSystem	0
Print Spooler	Spooler	Stopped	Manual Own Process	c:\winnt\system32\spoolsv.exe
		Normal	LocalSystem	0
SQLSERVERAGENT	SQLSERVERAGENT	Stopped	Manual Own Process	
	c:\progra~1\microso~2\mssql\binn\sqlagent.exe	Normal	LocalSystem	0
Performance Logs and Alerts	SysmonLog	Stopped	Manual Own Process	
	c:\winnt\system32\smlogsvc.exe	Normal	LocalSystem	0
Telephony	TapiSrv	Running	Auto	Share Process
		Normal	LocalSystem	0
Terminal Services	TermService	Stopped	Manual Own Process	
	c:\winnt\system32\termsrv.exe	Normal	LocalSystem	0
Telnet	TlntSvr	Stopped	Manual Own Process	c:\winnt\system32\tlntsvr.exe
		Normal	LocalSystem	0
Distributed Link Tracking Server	TrkSvr	Stopped	Manual Share Process	
	c:\winnt\system32\services.exe	Normal	LocalSystem	0
Distributed Link Tracking Client	TrkWks	Stopped	Manual Share Process	
	c:\winnt\system32\services.exe	Normal	LocalSystem	0
Uninterruptible Power Supply	UPS	Stopped	Manual Own Process	
	c:\winnt\system32\ups.exe	Normal	LocalSystem	0
Utility Manager	UtilMan	Stopped	Manual Own Process	c:\winnt\system32\utilman.exe
		Normal	LocalSystem	0
Windows Time	W32Time	Stopped	Manual Share Process	
	c:\winnt\system32\services.exe	Normal	LocalSystem	0
Windows Management Instrumentation	WinMgmt	Running	Auto	Own Process
	c:\winnt\system32\wbem\winmgmt.exe	Ignore	LocalSystem	0
Windows Management Instrumentation Driver Extensions	Wmi	Running	Auto	
	Share Process	c:\winnt\system32\services.exe	Normal	LocalSystem
			0	

[Program Groups]

Group Name	Name	User Name
Accessories	Default User:Accessories	Default User
Accessories\Accessibility	Default User:Accessories\Accessibility	Default User
Accessories\Entertainment	Default User:Accessories\Entertainment	Default User
Accessories\System Tools	Default User:Accessories\System Tools	Default User
Startup	Default User:Startup	Default User
Accessories	All Users:Accessories	All Users
Accessories\Accessibility	All Users:Accessories\Accessibility	All Users
Accessories\Communications	All Users:Accessories\Communications	All Users
Accessories\Entertainment	All Users:Accessories\Entertainment	All Users
Accessories\Games	All Users:Accessories\Games	All Users
Accessories\System Tools	All Users:Accessories\System Tools	All Users
Administrative Tools	All Users:Administrative Tools	All Users
Microsoft SQL Server	All Users:Microsoft SQL Server	All Users

Appendix C – Tunable Parameters

Startup All Users:Startup All Users
Accessories PE2500\Administrator:Accessories PE2500\Administrator
Accessories\Accessibility PE2500\Administrator:Accessories\Accessibility
PE2500\Administrator
Accessories\Entertainment PE2500\Administrator:Accessories\Entertainment
PE2500\Administrator
Accessories\System Tools PE2500\Administrator:Accessories\System Tools
PE2500\Administrator
Administrative Tools PE2500\Administrator:Administrative Tools PE2500\Administrator
Startup PE2500\Administrator:Startup PE2500\Administrator

[Startup Programs]

Program	Command	User Name	Location
No startup program information			

[OLE Registration]

Object	Local Server
Sound (OLE2)	sndrec32.exe
Media Clip	mplay32.exe
Video Clip	mplay32.exe /avi
MIDI Sequence	mplay32.exe /mid
Sound	Not Available
Media Clip	Not Available
Image Document	"C:\Program Files\Windows NT\Accessories\ImageVue\KodakImg.exe"
WordPad Document	"%ProgramFiles%\Windows NT\Accessories\WORDPAD.EXE"
Windows Media Services DRM Storage object	Not Available
Bitmap Image	mspaint.exe

[Internet Explorer 5]

[Following are sub-categories of this main category]

[Summary]

Item	Value
Version	5.00.2920.0000
Build	52920
Product ID	51876-OEM-0001501-00000
Application Path	C:\Program Files\Internet Explorer
Language	English (United States)
Active Printer	Not Available

Cipher Strength 56-bit
Content Advisor Disabled
IEAK Install No

[File Versions]

File	Version	Size	Date	Path	Company
advapi32.dll	5.0.2191.1	349 KB	12/7/1999 6:00:00 AM	C:\WINNT\system32	Microsoft Corporation
advapi32.dll	5.0.2191.1	349 KB	12/7/1999 6:00:00 AM	.	Microsoft Corporation

Appendix C – Tunable Parameters

advpack.dll	5.0.2920.0	87 KB	12/7/1999 6:00:00 AM	C:\WINNT\system32				
	Microsoft Corporation							
advpack.dll	5.0.2920.0	87 KB	12/7/1999 6:00:00 AM	.	Microsoft Corporation			
browselc.dll	5.0.2920.0	35 KB	12/7/1999 6:00:00 AM	C:\WINNT\system32				
	Microsoft Corporation							
browselc.dll	5.0.2920.0	35 KB	12/7/1999 6:00:00 AM	.	Microsoft Corporation			
browseui.dll	5.0.2920.0	793 KB	12/7/1999 6:00:00 AM	C:\WINNT\system32				
	Microsoft Corporation							
browseui.dll	5.0.2920.0	793 KB	12/7/1999 6:00:00 AM	.	Microsoft Corporation			
ckcnv.exe	5.0.2189.1	9 KB	12/7/1999 6:00:00 AM	C:\WINNT\system32				
	Microsoft Corporation							
ckcnv.exe	5.0.2189.1	9 KB	12/7/1999 6:00:00 AM	.	Microsoft Corporation			
comctl32.dll	5.81.2920.0	540 KB	12/7/1999 6:00:00 AM	C:\WINNT\system32				
	Microsoft Corporation							
comctl32.dll	5.81.2920.0	540 KB	12/7/1999 6:00:00 AM	.	Microsoft Corporation			
crypt32.dll	5.131.2173.1	466 KB	12/7/1999 6:00:00 AM	C:\WINNT\system32				
	Microsoft Corporation							
crypt32.dll	5.131.2173.1	466 KB	12/7/1999 6:00:00 AM	.	Microsoft Corporation			
ehsig.dll	<File Missing>	Not Available	Not Available	Not Available	Not Available			
iemigrat.dll	<File Missing>	Not Available	Not Available	Not Available	Not Available			
iesetup.dll	5.0.2920.0	57 KB	12/7/1999 6:00:00 AM	C:\WINNT\system32				
	Microsoft Corporation							
iesetup.dll	5.0.2920.0	57 KB	12/7/1999 6:00:00 AM	.	Microsoft Corporation			
ieexplore.exe	5.0.2920.0	59 KB	12/7/1999 6:00:00 AM	C:\Program Files\Internet Explorer				
	Microsoft Corporation							
imagehlp.dll	5.0.2195.1	125 KB	12/7/1999 6:00:00 AM	C:\WINNT\system32				
	Microsoft Corporation							
imagehlp.dll	5.0.2195.1	125 KB	12/7/1999 6:00:00 AM	.	Microsoft Corporation			
imghelp.dll	<File Missing>	Not Available	Not Available	Not Available	Not Available			
inseng.dll	5.0.2920.0	72 KB	12/7/1999 6:00:00 AM	C:\WINNT\system32				
	Microsoft Corporation							
inseng.dll	5.0.2920.0	72 KB	12/7/1999 6:00:00 AM	.	Microsoft Corporation			
jobexec.dll	5.0.0.1 47 KB	12/7/1999 6:00:00 AM	C:\WINNT\system32	Microsoft Corporation				
	Microsoft Corporation							
jobexec.dll	5.0.0.1 47 KB	12/7/1999 6:00:00 AM	.	Microsoft Corporation				
jscript.dll	5.1.0.4615	476 KB	12/7/1999 6:00:00 AM	C:\WINNT\system32				
	Microsoft Corporation							
jscript.dll	5.1.0.4615	476 KB	12/7/1999 6:00:00 AM	.	Microsoft Corporation			
jsproxy.dll	5.0.2920.0	13 KB	12/7/1999 6:00:00 AM	C:\WINNT\system32				
	Microsoft Corporation							
jsproxy.dll	5.0.2920.0	13 KB	12/7/1999 6:00:00 AM	.	Microsoft Corporation			
msaahtml.dll	<File Missing>	Not Available	Not Available	Not Available	Not Available			
mshhtml.dll	5.0.2920.0	2302 KB	12/7/1999 6:00:00 AM	C:\WINNT\system32				
	Microsoft Corporation							
mshhtml.dll	5.0.2920.0	2302 KB	12/7/1999 6:00:00 AM	.	Microsoft Corporation			
msjava.dll	5.0.3234.0	918 KB	12/7/1999 6:00:00 AM	C:\WINNT\system32				
	Microsoft Corporation							
msjava.dll	5.0.3234.0	918 KB	12/7/1999 6:00:00 AM	.	Microsoft Corporation			
msoss.dll	<File Missing>	Not Available	Not Available	Not Available	Not Available			
msxml.dll	5.0.2920.0	521 KB	12/7/1999 6:00:00 AM	C:\WINNT\system32				
	Microsoft Corporation							
msxml.dll	5.0.2920.0	521 KB	12/7/1999 6:00:00 AM	.	Microsoft Corporation			
occache.dll	5.0.2920.0	86 KB	12/7/1999 6:00:00 AM	C:\WINNT\system32				
	Microsoft Corporation							

Appendix C – Tunable Parameters

occache.dll	5.0.2920.0	86 KB	12/7/1999 6:00:00 AM	.	Microsoft Corporation
ole32.dll	5.0.2181.1	966 KB	12/7/1999 6:00:00 AM	C:\WINNT\system32	Microsoft Corporation
ole32.dll	5.0.2181.1	966 KB	12/7/1999 6:00:00 AM	.	Microsoft Corporation
oleaut32.dll	2.40.4512.1	600 KB	12/7/1999 6:00:00 AM	C:\WINNT\system32	Microsoft Corporation
oleaut32.dll	2.40.4512.1	600 KB	12/7/1999 6:00:00 AM	.	Microsoft Corporation
olepro32.dll	5.0.4512.1	160 KB	12/7/1999 6:00:00 AM	C:\WINNT\system32	Microsoft Corporation
olepro32.dll	5.0.4512.1	160 KB	12/7/1999 6:00:00 AM	.	Microsoft Corporation
rsabase.dll	5.0.2150.1	129 KB	12/7/1999 6:00:00 AM	C:\WINNT\system32	Microsoft Corporation
rsabase.dll	5.0.2150.1	129 KB	12/7/1999 6:00:00 AM	.	Microsoft Corporation
rsaenh.dll	<File Missing>	Not Available	Not Available	Not Available	Not Available
rsapi32.dll	<File Missing>	Not Available	Not Available	Not Available	Not Available
rsasig.dll	<File Missing>	Not Available	Not Available	Not Available	Not Available
schannel.dll	5.0.2170.0	140 KB	12/7/1999 6:00:00 AM	C:\WINNT\system32	Microsoft Corporation
schannel.dll	5.0.2170.0	140 KB	12/7/1999 6:00:00 AM	.	Microsoft Corporation
shdoc401.dll	<File Missing>	Not Available	Not Available	Not Available	Not Available
shdocvw.dll	5.0.2920.0	1078 KB	12/7/1999 6:00:00 AM	C:\WINNT\system32	Microsoft Corporation
shdocvw.dll	5.0.2920.0	1078 KB	12/7/1999 6:00:00 AM	.	Microsoft Corporation
shell32.dll	5.0.2920.0	2297 KB	12/7/1999 6:00:00 AM	C:\WINNT\system32	Microsoft Corporation
shell32.dll	5.0.2920.0	2297 KB	12/7/1999 6:00:00 AM	.	Microsoft Corporation
shlwapi.dll	5.0.2920.0	283 KB	12/7/1999 6:00:00 AM	C:\WINNT\system32	Microsoft Corporation
shlwapi.dll	5.0.2920.0	283 KB	12/7/1999 6:00:00 AM	.	Microsoft Corporation
url.dll	5.0.2920.0	82 KB	12/7/1999 6:00:00 AM	C:\WINNT\system32	Microsoft Corporation
url.dll	5.0.2920.0	82 KB	12/7/1999 6:00:00 AM	.	Microsoft Corporation
urlmon.dll	5.0.2920.0	427 KB	12/7/1999 6:00:00 AM	C:\WINNT\system32	Microsoft Corporation
urlmon.dll	5.0.2920.0	427 KB	12/7/1999 6:00:00 AM	.	Microsoft Corporation
vbscript.dll	5.1.0.4615	428 KB	12/7/1999 6:00:00 AM	C:\WINNT\system32	Microsoft Corporation
vbscript.dll	5.1.0.4615	428 KB	12/7/1999 6:00:00 AM	.	Microsoft Corporation
webcheck.dll	5.0.2920.0	252 KB	12/7/1999 6:00:00 AM	C:\WINNT\system32	Microsoft Corporation
webcheck.dll	5.0.2920.0	252 KB	12/7/1999 6:00:00 AM	.	Microsoft Corporation
win.com	5.0.2134.1	24 KB	12/7/1999 6:00:00 AM	C:\WINNT\system32	Microsoft Corporation
win.com	5.0.2134.1	24 KB	12/7/1999 6:00:00 AM	.	Microsoft Corporation
wininet.dll	5.0.2920.0	457 KB	12/7/1999 6:00:00 AM	C:\WINNT\system32	Microsoft Corporation
wininet.dll	5.0.2920.0	457 KB	12/7/1999 6:00:00 AM	.	Microsoft Corporation
winsock.dll	3.10.0.103	3 KB	12/7/1999 6:00:00 AM	C:\WINNT\system32	Microsoft Corporation
winsock.dll	3.10.0.103	3 KB	12/7/1999 6:00:00 AM	.	Microsoft Corporation
wintrust.dll	5.131.2143.1	162 KB	12/7/1999 6:00:00 AM	C:\WINNT\system32	Microsoft Corporation
wintrust.dll	5.131.2143.1	162 KB	12/7/1999 6:00:00 AM	.	Microsoft Corporation

Appendix C – Tunable Parameters

wsock.vxd	<File Missing>	Not Available	Not Available	Not Available	Not Available
wsock32.dll	5.0.2152.1	21 KB	12/7/1999 6:00:00 AM	C:\WINNT\system32	Microsoft Corporation
wsock32.dll	5.0.2152.1	21 KB	12/7/1999 6:00:00 AM	.	Microsoft Corporation
wsock32n.dll	<File Missing>	Not Available	Not Available	Not Available	Not Available

[Connectivity]

Item	Value
Connection Preference	Never dial
EnableHttp1.1	1
ProxyHttp1.1	0

LAN Settings

AutoConfigProxy	wininet.dll
AutoProxyDetectMode	Enabled
AutoConfigURL	
Proxy	Disabled
ProxyServer	
ProxyOverride	

[Cache]

[Following are sub-categories of this main category]

[Summary]

Item	Value
Page Refresh Type	Automatic
Temporary Internet Files Folder	C:\Documents and Settings\Administrator\Local Settings\Temporary Internet Files
Total Disk Space	17359 MB
Available Disk Space	13413 MB
Maximum Cache Size	542 MB
Available Cache Size	542 MB

[List of Objects]

Program File	Status	CodeBase
No cached object information available		

[Content]

[Following are sub-categories of this main category]

[Summary]

Item	Value
Content Advisor	Disabled

[Personal Certificates]

Issued To	Issued By	Validity	Signature Algorithm
Administrator	Administrator	11/14/2001 to 10/21/2101	sha1RSA
<hr/>			
Dell		213	DEC 14, 2001
TPC-C Full Disclosure Report			
Copyright Dell			

Appendix C – Tunable Parameters

[Other People Certificates]

Issued To Issued By Validity Signature Algorithm
No other people certificate information available

[Publishers]

Name
No publisher information available

[Security]

Zone	Security Level
Local intranet	Medium-low
Trusted sites	Low
Internet	Medium
Restricted sites	High

Appendix C – Tunable Parameters

Client Configuration Parameters

COM+ Settings

```
TPCC.AllTxns:
  Activation:
    Enable Object Pooling selected
    Minimum Pool Size: 160
    Maximum Pool Size: 160
    Creation Timeout: 60,000
    Enable Object Construction
    Enable Just in Time Activation
  Concurrency:
    Concurrency Required
```

TPCC Application Registry Parameters

Windows Registry Editor Version 5.00

```
[HKEY_LOCAL_MACHINE\SOFTWARE\Microsoft\TPCC]
"Path"="c:\\inetpub\\wwwroot\\"
"NumberOfDeliveryThreads"=dword:00000012
"MaxConnections"=dword:00002ee0
"MaxPendingDeliveries"=dword:000003e8
"DB_Protocol"="DBLIB"
"TxnMonitor"="COM"
"DbServer"="pe2500"
"DbName"="tpcc"
"DbUser"="sa"
"DbPassword"=""
"COM_SinglePool"="YES"
```

Microsoft Internet Information Server Registry Parameters

Windows Registry Editor Version 5.00

```
[HKEY_LOCAL_MACHINE\SYSTEM\CurrentControlSet\Services\InetInfo]

[HKEY_LOCAL_MACHINE\SYSTEM\CurrentControlSet\Services\InetInfo\Parameters]
"ListenBackLog"=dword:00000019
"DispatchEntries"=hex(7):4c,00,44,00,41,00,50,00,53,00,56,00,43,00,00,00,00,00
"PoolThreadLimit"=dword:000000be
"ThreadTimeout"=dword:00015180

[HKEY_LOCAL_MACHINE\SYSTEM\CurrentControlSet\Services\InetInfo\Performance]
"Library"="infectrs.dll"
"Open"="OpenINFOPerformanceData"
"Close"="CloseINFOPerformanceData"
"Collect"="CollectINFOPerformanceData"
"Last Counter"=dword:00000842
"Last Help"=dword:00000843
"First Counter"=dword:00000802
"First Help"=dword:00000803
"Library Validation Code"=hex:de,fc,ed,18,0a,98,c0,01,10,25,00,00,00,00,00,00
"WbemAdapFileTime"=hex:00,60,4e,96,aa,40,bf,01
"WbemAdapFileSize"=dword:00002510
"WbemAdapStatus"=dword:00000000
```

Appendix C – Tunable Parameters

Windows Registry Editor Version 5.00

```
[HKEY_LOCAL_MACHINE\SYSTEM\CurrentControlSet\Services\W3SVC]
"Type"=dword:00000020
"Start"=dword:00000002
"ErrorControl"=dword:00000001
"ImagePath"=hex(2):43,00,3a,00,5c,00,57,00,49,00,4e,00,4e,00,54,00,5c,00,53,00,\
  79,00,73,00,74,00,65,00,6d,00,33,00,32,00,5c,00,69,00,6e,00,65,00,74,00,73,\
  00,72,00,76,00,5c,00,69,00,6e,00,65,00,74,00,69,00,6e,00,66,00,6f,00,2e,00,\
  65,00,78,00,65,00,00,00
"DisplayName"="World Wide Web Publishing Service"
"DependOnService"=hex(7):49,00,49,00,53,00,41,00,44,00,4d,00,49,00,4e,00,00,00,\
  00,00
"DependOnGroup"=hex(7):00,00
"ObjectName"="LocalSystem"
"Description"="Provides Web connectivity and administration through the Internet
Information Services snap-in."

[HKEY_LOCAL_MACHINE\SYSTEM\CurrentControlSet\Services\W3SVC\ASP]
"NOTE"="This is for backward compatibility only."

[HKEY_LOCAL_MACHINE\SYSTEM\CurrentControlSet\Services\W3SVC\ASP\Parameters]

[HKEY_LOCAL_MACHINE\SYSTEM\CurrentControlSet\Services\W3SVC\Parameters]
"MajorVersion"=dword:00000005
"MinorVersion"=dword:00000000
"InstallPath"="C:\\WINNT\\System32\\inetsrv"
"CertMapList"="C:\\WINNT\\System32\\inetsrv\\iisrcmap.dll"
"AccessDeniedMessage"="Error: Access is Denied."
"Filter DLLs"=""
"LogFileDirectory"="C:\\WINNT\\System32\\LogFiles"
"AcceptExOutstanding"=dword:00000028

[HKEY_LOCAL_MACHINE\SYSTEM\CurrentControlSet\Services\W3SVC\Parameters\ADCLaunch]

[HKEY_LOCAL_MACHINE\SYSTEM\CurrentControlSet\Services\W3SVC\Parameters\ADCLaunch\Advanced
DataFactory]

[HKEY_LOCAL_MACHINE\SYSTEM\CurrentControlSet\Services\W3SVC\Parameters\ADCLaunch\RDSServe
r.DataFactory]

[HKEY_LOCAL_MACHINE\SYSTEM\CurrentControlSet\Services\W3SVC\Parameters\Script Map]

[HKEY_LOCAL_MACHINE\SYSTEM\CurrentControlSet\Services\W3SVC\Parameters\Virtual Roots]
"/"="c:\\inetpub\\wwwroot,,205"
"/Scripts"="c:\\inetpub\\scripts,,204"
"/IISHelp"="c:\\winnt\\help\\iishelp,,201"
"/IISAdmin"="C:\\WINNT\\System32\\inetsrv\\iisadmin,,201"
"/IISamples"="c:\\inetpub\\iissamples,,201"
"/MSADC"="c:\\program files\\common files\\system\\msadc,,205"
"/_vti_bin"="C:\\Program Files\\Common Files\\Microsoft Shared\\Web Server
Extensions\\40\\isapi,,205"
"/Rpc"="C:\\WINNT\\System32\\RpcProxy,,4"
"/Printers"="C:\\WINNT\\web\\printers,,201"

[HKEY_LOCAL_MACHINE\SYSTEM\CurrentControlSet\Services\W3SVC\Performance]
"Library"="w3ctrs.dll"
"Open"="OpenW3PerformanceData"
"Close"="CloseW3PerformanceData"
"Collect"="CollectW3PerformanceData"
"Last Counter"=dword:000008e6
"Last Help"=dword:000008e7
"First Counter"=dword:00000844
"First Help"=dword:00000845
"Library Validation Code"=hex:86,2b,a6,1b,0a,98,c0,01,10,3d,00,00,00,00,00,00
"WbemAdapFileTime"=hex:00,60,4e,96,aa,40,bf,01
"WbemAdapFileSize"=dword:00003d10
"WbemAdapStatus"=dword:00000000
```

Appendix C – Tunable Parameters

```
[HKEY_LOCAL_MACHINE\SYSTEM\CurrentControlSet\Services\W3SVC\Security]
"Security"=hex:01,00,14,80,a0,00,00,00,ac,00,00,00,14,00,00,00,30,00,00,00,02,\
00,1c,00,01,00,00,00,02,80,14,00,ff,01,0f,00,01,01,00,00,00,00,00,01,00,00,\
00,00,02,00,70,00,04,00,00,00,00,00,18,00,fd,01,02,00,01,01,00,00,00,00,00,\
05,12,00,00,00,74,00,6f,00,00,00,1c,00,ff,01,0f,00,01,02,00,00,00,00,00,05,\
20,00,00,00,20,02,00,00,72,00,73,00,00,00,18,00,8d,01,02,00,01,01,00,00,00,\
00,00,05,0b,00,00,00,20,02,00,00,00,00,1c,00,fd,01,02,00,01,02,00,00,00,\
00,05,20,00,00,00,23,02,00,00,72,00,73,00,01,01,00,00,00,00,00,05,12,00,00,\
00,01,01,00,00,00,00,00,05,12,00,00,00

[HKEY_LOCAL_MACHINE\SYSTEM\CurrentControlSet\Services\W3SVC\Enum]
"0"="Root\\LEGACY_W3SVC\\0000"
"Count"=dword:00000001
"NextInstance"=dword:00000001
```

Windows 2000 Server System Information Report For PE1400

System Information report written at: 10/16/2001 04:30:32 PM

[System Information]

[Following are sub-categories of this main category]

[System Summary]

Item	Value
OS Name	Microsoft Windows 2000 Server
Version	5.0.2195 Build 2195
OS Manufacturer	Microsoft Corporation
System Name	CLIENT3
System Manufacturer	Dell Computer Corporation
System Model	PowerEdge 1400
System Type	X86-based PC
Processor	x86 Family 6 Model 8 Stepping 6 GenuineIntel ~1000 Mhz
BIOS Version	Phoenix ROM BIOS PLUS Version 1.10 A03
Windows Directory	C:\WINNT
System Directory	C:\WINNT\System32
Boot Device	\Device\Harddisk0\Partition1
Locale	United States
User Name	CLIENT3\Administrator
Time Zone	Central Daylight Time
Total Physical Memory	523,816 KB
Available Physical Memory	332,560 KB
Total Virtual Memory	1,802,240 KB
Available Virtual Memory	1,440,316 KB
Page File Space	1,278,424 KB
Page File	C:\pagefile.sys

[Hardware Resources]

[Following are sub-categories of this main category]

[Conflicts/Sharing]

Resource	Device
No conflicted/shared resources	

Appendix C – Tunable Parameters

[DMA]

Channel	Device	Status
4	Direct memory access controller	OK
2	Standard floppy disk controller	OK

[Forced Hardware]

Device PNP Device ID
No Forced Hardware

[I/O]

Address Range	Device	Status
0x0000-0x03AF	PCI bus	OK
0x0000-0x03AF	Direct memory access controller	OK
0x03B0-0x03DF	PCI bus	OK
0x03B0-0x03DF	ATI Technologies Inc. RAGE XL PCI	OK
0x03E0-0x0FFF	PCI bus	OK
0xE000-0xEFFF	PCI bus	OK
0xECA0-0xECBF	Intel(R) PRO/100+ PCI Adapter	OK
0xEC80-0xEC9F	Intel(R) PRO/100+ PCI Adapter #2	OK
0xE800-0xE8FF	ATI Technologies Inc. RAGE XL PCI	OK
0x03C0-0x03DF	ATI Technologies Inc. RAGE XL PCI	OK
0x0A79-0x0A79	ISAPNP Read Data Port	OK
0x0279-0x0279	ISAPNP Read Data Port	OK
0x02F4-0x02F7	ISAPNP Read Data Port	OK
0x0080-0x009F	Direct memory access controller	OK
0x00C0-0x00DF	Direct memory access controller	OK
0x00F0-0x00FF	Numeric data processor	OK
0x0020-0x003F	Programmable interrupt controller	OK
0x00A0-0x00BF	Programmable interrupt controller	OK
0x04D0-0x04D1	Programmable interrupt controller	OK
0x0061-0x0061	System speaker	OK
0x0040-0x005F	System timer	OK
0x03F0-0x03F5	Standard floppy disk controller	OK
0x03F7-0x03F7	Standard floppy disk controller	OK
0x0060-0x0060	Standard 101/102-Key or Microsoft Natural PS/2 Keyboard	OK
0x0064-0x0064	Standard 101/102-Key or Microsoft Natural PS/2 Keyboard	OK
0x03F8-0x03FF	Communications Port (COM1)	OK
0x02F8-0x02FF	Communications Port (COM2)	OK
0x0378-0x037F	ECP Printer Port (LPT1)	OK
0x0778-0x077F	ECP Printer Port (LPT1)	OK
0x0070-0x007F	System CMOS/real time clock	OK
0x0814-0x085B	System board	OK
0x0580-0x058F	System board	OK
0x0C00-0x0CD7	System board	OK
0x0F50-0x0F58	System board	OK
0x00E0-0x00EF	System board	OK
0x08B0-0x08BF	Standard Dual Channel PCI IDE Controller	OK
0x01F0-0x01F7	Primary IDE Channel	OK
0x03F6-0x03F6	Primary IDE Channel	OK
0x0170-0x0177	Secondary IDE Channel	OK
0x0376-0x0376	Secondary IDE Channel	OK

Appendix C – Tunable Parameters

0xD000-0xDFFF	PCI busOK	
0xDC00-0xDCFF	Adaptec AIC-7899 Ultra160/m PCI SCSI Card	OK
0xD800-0xD8FF	Adaptec AIC-7899 Ultra160/m PCI SCSI Card	OK

[IRQs]

IRQ Number	Device
9	Microsoft ACPI-Compliant System
25	Intel(R) PRO/100+ PCI Adapter
28	Intel(R) PRO/100+ PCI Adapter #2
13	Numeric data processor
6	Standard floppy disk controller
1	Standard 101/102-Key or Microsoft Natural PS/2 Keyboard
12	PS/2 Compatible Mouse
4	Communications Port (COM1)
3	Communications Port (COM2)
8	System CMOS/real time clock
14	Primary IDE Channel
30	Adaptec AIC-7899 Ultra160/m PCI SCSI Card
31	Adaptec AIC-7899 Ultra160/m PCI SCSI Card

[Memory]

Range	Device	Status
0xA0000-0xBFFFF	PCI busOK	
0xA0000-0xBFFFF	ATI Technologies Inc. RAGE XL PCI	OK
0xD8000-0xEFFFF	PCI busOK	
0xF9000000-0xFE30FFFF	PCI busOK	
0xFB001000-0xFB001FFF	Intel(R) PRO/100+ PCI Adapter	OK
0xFE100000-0xFE1FFFFF	Intel(R) PRO/100+ PCI Adapter	OK
0xFB000000-0xFB000FFF	Intel(R) PRO/100+ PCI Adapter #2	OK
0xFE000000-0xFE0FFFFF	Intel(R) PRO/100+ PCI Adapter #2	OK
0xFC000000-0xFCFFFFFF	ATI Technologies Inc. RAGE XL PCI	OK
0xFE300000-0xFE300FFF	ATI Technologies Inc. RAGE XL PCI	OK
0xF4000000-0xF823FFFF	PCI busOK	
0xF8231000-0xF8231FFF	Adaptec AIC-7899 Ultra160/m PCI SCSI Card	OK
0xF8230000-0xF8230FFF	Adaptec AIC-7899 Ultra160/m PCI SCSI Card	OK
0x0000-0x9FFFF	System board	OK
0x100000-0xFFFFFFFF	System board	OK
0x1000000-0x1FFFFFFF	System board	OK
0xF0000-0xFFFFF	System board	OK
0xFEC00000-0xFEC0FFFF	System board	OK
0xFEE00000-0xFEE0FFFF	System board	OK
0xFFE00000-0xFFFFFFFF	System board	OK

[Components]

[Following are sub-categories of this main category]

[Multimedia]

[Following are sub-categories of this main category]

[Audio Codecs]

Appendix C – Tunable Parameters

Codec	Manufacturer	Description	Status	File	Version	Size	Creation Date
c:\winnt\system32\iac25_32.ax	Intel Corporation				Indeo® audio software	OK	
		C:\WINNT\System32\IAC25_32.AX		2.05.53	195.00 KB (199,680 bytes)		12/7/1999 6:00:00 AM
c:\winnt\system32\msg723.acm	Microsoft Corporation					OK	
		C:\WINNT\System32\MSG723.ACM		4.4.3385	106.77 KB (109,328 bytes)		2/16/2001 11:23:07 AM
c:\winnt\system32\lhacm.acm	Microsoft Corporation					OK	
		C:\WINNT\System32\LHACM.ACM		4.4.3385	33.27 KB (34,064 bytes)		2/16/2001 11:23:08 AM
c:\winnt\system32\tssoft32.acm	DSP GROUP, INC.					OK	
		C:\WINNT\System32\TSSOFT32.ACM		1.01	9.27 KB (9,488 bytes)		12/7/1999 6:00:00 AM
c:\winnt\system32\msgsm32.acm	Microsoft Corporation					OK	
		C:\WINNT\System32\MSGSM32.ACM		5.00.2134.1	22.27 KB (22,800 bytes)		12/7/1999 6:00:00 AM
c:\winnt\system32\msg711.acm	Microsoft Corporation					OK	
		C:\WINNT\System32\MSG711.ACM		5.00.2134.1	10.27 KB (10,512 bytes)		12/7/1999 6:00:00 AM
c:\winnt\system32\msadp32.acm	Microsoft Corporation					OK	
		C:\WINNT\System32\MSADP32.ACM		5.00.2134.1	14.77 KB (15,120 bytes)		12/7/1999 6:00:00 AM
c:\winnt\system32\imaadp32.acm	Microsoft Corporation					OK	
		C:\WINNT\System32\IMAADP32.ACM		5.00.2134.1	16.27 KB (16,656 bytes)		12/7/1999 6:00:00 AM

[Video Codecs]

Codec	Manufacturer	Description	Status	File	Version	Size	Creation Date
c:\winnt\system32\ir50_32.dll	Intel Corporation				Indeo® video 5.10	OK	
		C:\WINNT\System32\IR50_32.DLL		R.5.10.15.2.55	737.50 KB (755,200 bytes)		12/7/1999 6:00:00 AM
c:\winnt\system32\msh261.drv	Microsoft Corporation					OK	
		C:\WINNT\System32\MSH261.DRV		4.4.3385	163.77 KB (167,696 bytes)		2/16/2001 11:23:08 AM
c:\winnt\system32\msh263.drv	Microsoft Corporation					OK	
		C:\WINNT\System32\MSH263.DRV		4.4.3385	252.27 KB (258,320 bytes)		2/16/2001 11:22:37 AM
c:\winnt\system32\msrle32.dll	Microsoft Corporation					OK	
		C:\WINNT\System32\MSRLE32.DLL		5.00.2134.1	10.77 KB (11,024 bytes)		12/7/1999 6:00:00 AM
c:\winnt\system32\ir32_32.dll	Intel(R) Corporation					OK	
		C:\WINNT\System32\IR32_32.DLL		Not Available	194.50 KB (199,168 bytes)		12/7/1999 6:00:00 AM
c:\winnt\system32\iccvid.dll	Radius Inc.					OK	
		C:\WINNT\System32\ICCVID.DLL		1.10.0.6	108.00 KB (110,592 bytes)		12/7/1999 6:00:00 AM
c:\winnt\system32\msvidc32.dll	Microsoft Corporation					OK	
		C:\WINNT\System32\MSVIDC32.DLL		5.00.2134.1	27.27 KB (27,920 bytes)		12/7/1999 6:00:00 AM

[CD-ROM]

Item Value
Drive D:

Dell 220 DEC 14, 2001
TPC-C Full Disclosure Report
Copyright Dell

Appendix C – Tunable Parameters

Description CD-ROM Drive
Media Loaded True
Media Type CD-ROM
Name SAMSUNG CD-ROM SC-148F
Manufacturer (Standard CD-ROM drives)
Status OK
Transfer Rate 296.30 kbytes/sec
SCSI Target ID 0
PNP Device ID IDE\CDROMSAMSUNG_CD-ROM_SC-148F_____F008____\5&F3420B7&0&0.0.0

[Sound Device]

Item Value
No sound devices

[Display]

Item Value
Name ATI Technologies Inc. RAGE XL PCI
PNP Device ID
PCI\VEN_1002&DEV_4752&SUBSYS_00CE1028&REV_27\3&13C0B0C5&0&70
Adapter Type ATI RAGE XL PCI, ATI Technologies Inc. compatible
Adapter Description ATI Technologies Inc. RAGE XL PCI
Adapter RAM 4.00 MB (4,194,304 bytes)
Installed Driversatidrab.dll
Driver Version 5.00.2179.1
INF File display.inf (atirage3 section)
Color Planes 1
Color Table Entries 256
Resolution 1024 x 768 x 60 hertz
Bits/Pixel 8

[Infrared]

Item Value
No infrared devices

[Input]

[Following are sub-categories of this main category]

[Keyboard]

Item Value
Description Standard 101/102-Key or Microsoft Natural PS/2 Keyboard
Name Enhanced (101- or 102-key)
Layout 00000409
PNP Device ID ACPI\PNP0303\4&14E2F907&0
NumberOfFunctionKeys 12

[Pointing Device]

Appendix C – Tunable Parameters

Item Value
Hardware Type PS/2 Compatible Mouse
Number of Buttons 2
Status OK
PNP Device ID ACPI\PNP0F13\4&14E2F907&0
Power Management Supported False
Double Click Threshold 6
Handedness Right Handed Operation

[Modem]

Item Value
No modems

[Network]

[Following are sub-categories of this main category]

[Adapter]

Item Value
Name [00000000] Intel(R) PRO/100+ PCI Adapter
Adapter Type Ethernet 802.3
Product Name Intel(R) PRO/100+ PCI Adapter
Installed True
PNP Device ID PCI\VEN_8086&DEV_1229&SUBSYS_00098086&REV_05\3&13C0B0C5&0&20
Last Reset 10/16/2001 10:46:57 AM
Index 0
Service Name E100B
IP Address 192.1.30.100
IP Subnet 255.255.255.0
Default IP Gateway Not Available
DHCP Enabled False
DHCP Server Not Available
DHCP Lease Expires Not Available
DHCP Lease Obtained Not Available
MAC Address 00:90:27:5C:D1:98
Service Name E100B
IRQ Number 25
I/O Port 0xECA0-0xECBF
Driver c:\winnt\system32\drivers\e100bnt5.sys (80144, 4.01.67.0000)

Name [00000001] Intel 8255x-based PCI Ethernet Adapter (10/100)
Adapter Type Not Available
Product Name Intel 8255x-based PCI Ethernet Adapter (10/100)
Installed True
PNP Device ID PCI\VEN_8086&DEV_1229&SUBSYS_009B1028&REV_08\3&13C0B0C5&0&10
Last Reset 10/16/2001 10:46:57 AM
Index 1
Service Name E100B
IP Address Not Available
IP Subnet Not Available
Default IP Gateway Not Available

Appendix C – Tunable Parameters

DHCP Enabled True
DHCP Server Not Available
DHCP Lease Expires Not Available
DHCP Lease Obtained Not Available
MAC Address Not Available
Service Name E100B
Driver c:\winnt\system32\drivers\e100bnt5.sys (80144, 4.01.67.0000)

Name [00000002] RAS Async Adapter
Adapter Type Not Available
Product Name RAS Async Adapter
Installed True
PNP Device ID Not Available
Last Reset 10/16/2001 10:46:57 AM
Index 2
Service Name AsyncMac
IP Address Not Available
IP Subnet Not Available
Default IP Gateway Not Available
DHCP Enabled False
DHCP Server Not Available
DHCP Lease Expires Not Available
DHCP Lease Obtained Not Available
MAC Address Not Available
Service Name Not Available

Name [00000003] WAN Miniport (L2TP)
Adapter Type Not Available
Product Name WAN Miniport (L2TP)
Installed True
PNP Device ID ROOT\MS_L2TPMINIPORT\0000
Last Reset 10/16/2001 10:46:57 AM
Index 3
Service Name Rasl2tp
IP Address Not Available
IP Subnet Not Available
Default IP Gateway Not Available
DHCP Enabled False
DHCP Server Not Available
DHCP Lease Expires Not Available
DHCP Lease Obtained Not Available
MAC Address Not Available
Service Name Rasl2tp
Driver c:\winnt\system32\drivers\rasl2tp.sys (50800, 5.00.2179.1)

Name [00000004] WAN Miniport (PPTP)
Adapter Type Wide Area Network (WAN)
Product Name WAN Miniport (PPTP)
Installed True
PNP Device ID ROOT\MS_PPTPMINIPORT\0000
Last Reset 10/16/2001 10:46:57 AM
Index 4
Service Name PptpMiniport
IP Address Not Available
IP Subnet Not Available

Appendix C – Tunable Parameters

Default IP Gateway Not Available
DHCP Enabled False
DHCP Server Not Available
DHCP Lease Expires Not Available
DHCP Lease Obtained Not Available
MAC Address 50:50:54:50:30:30
Service Name PptpMiniport
Driver c:\winnt\system32\drivers\rasppptp.sys (47856, 5.00.2160.1)

Name [00000005] Direct Parallel
Adapter Type Not Available
Product Name Direct Parallel
Installed True
PNP Device ID ROOT\MS_PTMINIPOINT\0000
Last Reset 10/16/2001 10:46:57 AM
Index 5
Service Name Raspti
IP Address Not Available
IP Subnet Not Available
Default IP Gateway Not Available
DHCP Enabled False
DHCP Server Not Available
DHCP Lease Expires Not Available
DHCP Lease Obtained Not Available
MAC Address Not Available
Service Name Raspti
Driver c:\winnt\system32\drivers\raspti.sys (16880, 5.00.2146.1)

Name [00000006] WAN Miniport (IP)
Adapter Type Not Available
Product Name WAN Miniport (IP)
Installed True
PNP Device ID ROOT\MS_NDISWANIP\0000
Last Reset 10/16/2001 10:46:57 AM
Index 6
Service Name NdisWan
IP Address Not Available
IP Subnet Not Available
Default IP Gateway Not Available
DHCP Enabled False
DHCP Server Not Available
DHCP Lease Expires Not Available
DHCP Lease Obtained Not Available
MAC Address Not Available
Service Name NdisWan
Driver c:\winnt\system32\drivers\ndiswan.sys (90768, 5.00.2184.1)

Name [00000007] cLAN Host Adapter
Adapter Type Not Available
Product Name cLAN Host Adapter
Installed True
PNP Device ID PCI\VEN_135B&DEV_0001&SUBSYS_00000000&REV_00\3&1070020&0&20
Last Reset 10/16/2001 10:46:57 AM
Index 7
Service Name GNINDIS

Appendix C – Tunable Parameters

IP Address Not Available
IP Subnet Not Available
Default IP Gateway Not Available
DHCP Enabled False
DHCP Server Not Available
DHCP Lease Expires Not Available
DHCP Lease Obtained Not Available
MAC Address Not Available
Service Name GNINDIS
Driver c:\winnt\system32\drivers\gnindis.sys (22598, 4.1.1)

Name [00000008] Intel(R) PRO/100+ PCI Adapter
Adapter Type Ethernet 802.3
Product Name Intel(R) PRO/100+ PCI Adapter
Installed True
PNP Device ID PCI\VEN_8086&DEV_1229&SUBSYS_00098086&REV_05\3&13C0B0C5&0&30
Last Reset 10/16/2001 10:46:57 AM
Index 8
Service Name E100B
IP Address 192.1.1.3
IP Subnet 255.255.255.0
Default IP Gateway Not Available
DHCP Enabled False
DHCP Server Not Available
DHCP Lease Expires Not Available
DHCP Lease Obtained Not Available
MAC Address 00:90:27:5C:D4:60
Service Name E100B
IRQ Number 28
I/O Port 0xEC80-0xEC9F
Driver c:\winnt\system32\drivers\e100bnt5.sys (80144, 4.01.67.0000)

[Protocol]

Item Value
Name MSAFD Tcpip [TCP/IP]
ConnectionlessService False
GuaranteesDelivery True
GuaranteesSequencing True
MaximumAddressSize 16 bytes
MaximumMessageSize 0 bytes
MessageOriented False
MinimumAddressSize 16 bytes
PseudoStreamOriented False
SupportsBroadcasting False
SupportsConnectData False
SupportsDisconnectData False
SupportsEncryption False
SupportsExpeditedData True
SupportsGracefulClosing True
SupportsGuaranteedBandwidth False
SupportsMulticasting False

Name MSAFD Tcpip [UDP/IP]

Appendix C – Tunable Parameters

ConnectionlessService True
GuaranteesDelivery False
GuaranteesSequencing False
MaximumAddressSize 16 bytes
MaximumMessageSize 65467 bytes
MessageOriented True
MinimumAddressSize 16 bytes
PseudoStreamOriented False
SupportsBroadcasting True
SupportsConnectData False
SupportsDisconnectData False
SupportsEncryption False
SupportsExpeditedData False
SupportsGracefulClosing False
SupportsGuaranteedBandwidth False
SupportsMulticasting True

Name RSVP UDP Service Provider

ConnectionlessService True
GuaranteesDelivery False
GuaranteesSequencing False
MaximumAddressSize 16 bytes
MaximumMessageSize 65467 bytes
MessageOriented True
MinimumAddressSize 16 bytes
PseudoStreamOriented False
SupportsBroadcasting True
SupportsConnectData False
SupportsDisconnectData False
SupportsEncryption True
SupportsExpeditedData False
SupportsGracefulClosing False
SupportsGuaranteedBandwidth False
SupportsMulticasting True

Name RSVP TCP Service Provider

ConnectionlessService False
GuaranteesDelivery True
GuaranteesSequencing True
MaximumAddressSize 16 bytes
MaximumMessageSize 0 bytes
MessageOriented False
MinimumAddressSize 16 bytes
PseudoStreamOriented False
SupportsBroadcasting False
SupportsConnectData False
SupportsDisconnectData False
SupportsEncryption True
SupportsExpeditedData True
SupportsGracefulClosing True
SupportsGuaranteedBandwidth False
SupportsMulticasting False

Name MSAFD NetBIOS [Device\NetBT_Tcpip_{7F28470E-1818-45F5-BA92-D2EAEFFA3A3D}] SECPACKET 5

Appendix C – Tunable Parameters

ConnectionlessService False
GuaranteesDelivery True
GuaranteesSequencing True
MaximumAddressSize 20 bytes
MaximumMessageSize 64000 bytes
MessageOriented True
MinimumAddressSize 20 bytes
PseudoStreamOriented False
SupportsBroadcasting False
SupportsConnectData False
SupportsDisconnectData False
SupportsEncryption False
SupportsExpeditedData False
SupportsGracefulClosing False
SupportsGuaranteedBandwidth False
SupportsMulticasting False

Name MSAFD NetBIOS [Device\NetBT_Tcpip_{7F28470E-1818-45F5-BA92-D2EAEEFA3A3D}] DATAGRAM 5

ConnectionlessService True
GuaranteesDelivery False
GuaranteesSequencing False
MaximumAddressSize 20 bytes
MaximumMessageSize 64000 bytes
MessageOriented True
MinimumAddressSize 20 bytes
PseudoStreamOriented False
SupportsBroadcasting True
SupportsConnectData False
SupportsDisconnectData False
SupportsEncryption False
SupportsExpeditedData False
SupportsGracefulClosing False
SupportsGuaranteedBandwidth False
SupportsMulticasting False

Name MSAFD NetBIOS [Device\NetBT_Tcpip_{4C4DAE74-4007-4939-B7C1-D352BD42F36B}] SEQPACKET 4

ConnectionlessService False
GuaranteesDelivery True
GuaranteesSequencing True
MaximumAddressSize 20 bytes
MaximumMessageSize 64000 bytes
MessageOriented True
MinimumAddressSize 20 bytes
PseudoStreamOriented False
SupportsBroadcasting False
SupportsConnectData False
SupportsDisconnectData False
SupportsEncryption False
SupportsExpeditedData False
SupportsGracefulClosing False
SupportsGuaranteedBandwidth False
SupportsMulticasting False

Appendix C – Tunable Parameters

Name MSAFD NetBIOS [Device\NetBT_Tcpip_{4C4DAE74-4007-4939-B7C1-D352BD42F36B}] DATAGRAM 4
ConnectionlessService True
GuaranteesDelivery False
GuaranteesSequencing False
MaximumAddressSize 20 bytes
MaximumMessageSize 64000 bytes
MessageOriented True
MinimumAddressSize 20 bytes
PseudoStreamOriented False
SupportsBroadcasting True
SupportsConnectData False
SupportsDisconnectData False
SupportsEncryption False
SupportsExpeditedData False
SupportsGracefulClosing False
SupportsGuaranteedBandwidth False
SupportsMulticasting False

Name MSAFD NetBIOS [Device\NetBT_Tcpip_{0F52C741-CF89-4A57-ADDF-6C498B2B5C5E}] SEQPACKET 0
ConnectionlessService False
GuaranteesDelivery True
GuaranteesSequencing True
MaximumAddressSize 20 bytes
MaximumMessageSize 64000 bytes
MessageOriented True
MinimumAddressSize 20 bytes
PseudoStreamOriented False
SupportsBroadcasting False
SupportsConnectData False
SupportsDisconnectData False
SupportsEncryption False
SupportsExpeditedData False
SupportsGracefulClosing False
SupportsGuaranteedBandwidth False
SupportsMulticasting False

Name MSAFD NetBIOS [Device\NetBT_Tcpip_{0F52C741-CF89-4A57-ADDF-6C498B2B5C5E}] DATAGRAM 0
ConnectionlessService True
GuaranteesDelivery False
GuaranteesSequencing False
MaximumAddressSize 20 bytes
MaximumMessageSize 64000 bytes
MessageOriented True
MinimumAddressSize 20 bytes
PseudoStreamOriented False
SupportsBroadcasting True
SupportsConnectData False
SupportsDisconnectData False
SupportsEncryption False
SupportsExpeditedData False
SupportsGracefulClosing False
SupportsGuaranteedBandwidth False

Appendix C – Tunable Parameters

SupportsMulticasting False

Name MSAFD NetBIOS [Device\NetBT_Tcpip_{53975049-680C-4C3D-A4CF-317CC4811AD4}] SEQUENCEPACKET 1

ConnectionlessService False
GuaranteesDelivery True
GuaranteesSequencing True
MaximumAddressSize 20 bytes
MaximumMessageSize 64000 bytes
MessageOriented True
MinimumAddressSize 20 bytes
PseudoStreamOriented False
SupportsBroadcasting False
SupportsConnectData False
SupportsDisconnectData False
SupportsEncryption False
SupportsExpeditedData False
SupportsGracefulClosing False
SupportsGuaranteedBandwidth False
SupportsMulticasting False

Name MSAFD NetBIOS [Device\NetBT_Tcpip_{53975049-680C-4C3D-A4CF-317CC4811AD4}] DATAGRAM 1

ConnectionlessService True
GuaranteesDelivery False
GuaranteesSequencing False
MaximumAddressSize 20 bytes
MaximumMessageSize 64000 bytes
MessageOriented True
MinimumAddressSize 20 bytes
PseudoStreamOriented False
SupportsBroadcasting True
SupportsConnectData False
SupportsDisconnectData False
SupportsEncryption False
SupportsExpeditedData False
SupportsGracefulClosing False
SupportsGuaranteedBandwidth False
SupportsMulticasting False

Name MSAFD NetBIOS [Device\NetBT_Tcpip_{F6854AC0-072C-450B-B073-FD3E0C7B3152}] SEQUENCEPACKET 2

ConnectionlessService False
GuaranteesDelivery True
GuaranteesSequencing True
MaximumAddressSize 20 bytes
MaximumMessageSize 64000 bytes
MessageOriented True
MinimumAddressSize 20 bytes
PseudoStreamOriented False
SupportsBroadcasting False
SupportsConnectData False
SupportsDisconnectData False
SupportsEncryption False
SupportsExpeditedData False

Appendix C – Tunable Parameters

SupportsGracefulClosing False
SupportsGuaranteedBandwidth False
SupportsMulticasting False

Name MSAFD NetBIOS [\Device\NetBT_Tcpip_{F6854AC0-072C-450B-B073-FD3E0C7B3152}] DATAGRAM 2

ConnectionlessService True
GuaranteesDelivery False
GuaranteesSequencing False
MaximumAddressSize 20 bytes
MaximumMessageSize 64000 bytes
MessageOriented True
MinimumAddressSize 20 bytes
PseudoStreamOriented False
SupportsBroadcasting True
SupportsConnectData False
SupportsDisconnectData False
SupportsEncryption False
SupportsExpeditedData False
SupportsGracefulClosing False
SupportsGuaranteedBandwidth False
SupportsMulticasting False

Name MSAFD NetBIOS [\Device\NetBT_Tcpip_{CC273023-EFA3-4001-978D-169135B56664}] SEQPACKET 3

ConnectionlessService False
GuaranteesDelivery True
GuaranteesSequencing True
MaximumAddressSize 20 bytes
MaximumMessageSize 64000 bytes
MessageOriented True
MinimumAddressSize 20 bytes
PseudoStreamOriented False
SupportsBroadcasting False
SupportsConnectData False
SupportsDisconnectData False
SupportsEncryption False
SupportsExpeditedData False
SupportsGracefulClosing False
SupportsGuaranteedBandwidth False
SupportsMulticasting False

Name MSAFD NetBIOS [\Device\NetBT_Tcpip_{CC273023-EFA3-4001-978D-169135B56664}] DATAGRAM 3

ConnectionlessService True
GuaranteesDelivery False
GuaranteesSequencing False
MaximumAddressSize 20 bytes
MaximumMessageSize 64000 bytes
MessageOriented True
MinimumAddressSize 20 bytes
PseudoStreamOriented False
SupportsBroadcasting True
SupportsConnectData False
SupportsDisconnectData False

Appendix C – Tunable Parameters

SupportsEncryption False
SupportsExpeditedData False
SupportsGracefulClosing False
SupportsGuaranteedBandwidth False
SupportsMulticasting False

[WinSock]

Item Value
File c:\winnt\system32\winsock.dll
Version 3.10
Size 2.80 KB (2,864 bytes)

File c:\winnt\system32\wsock32.dll
Version 5.00.2152.1
Size 21.27 KB (21,776 bytes)

[Ports]

[Following are sub-categories of this main category]

[Serial]

Item Value
Name COM1
Status OK
PNP Device ID ACPI\PNP0501\1
Maximum Input Buffer Size Not Available
Maximum Output Buffer Size Not Available
Settable Baud Rate Not Available
Settable Data Bits Not Available
Settable Flow Control Not Available
Settable Parity Not Available
Settable Parity Check Not Available
Settable Stop Bits Not Available
Settable RLSD Not Available
Supports RLSD Not Available
Supports 16 Bit Mode Not Available
Supports Special Characters Not Available
Baud Rate 9600
Bits/Byte 8
Stop Bits 1
Parity None
Busy -1
Abort Read/Write on Error Not Available
Binary Mode Enabled Not Available
Continue XMit on XOff Not Available
CTS Outflow Control Not Available
Discard NULL Bytes Not Available
DSR Outflow Control Not Available
DSR Sensitivity Not Available
DTR Flow Control Type Not Available
EOF Character Not Available

Appendix C – Tunable Parameters

Error Replace Character Not Available
Error Replacement Enabled Not Available
Event Character Not Available
Parity Check Enabled -1
RTS Flow Control Type Not Available
XOff Character 19
XOffXMit Threshold 512
XOn Character 17
XOnXMit Threshold 2048
XOnXOff InFlow Control Not Available
XOnXOff OutFlow Control Not Available
IRQ Number 4
I/O Port 0x03F8-0x03FF
Driver c:\winnt\system32\drivers\serial.sys (62448, 5.00.2134.1)

Name COM2
Status OK
PNP Device ID ACPI\PNP0501\2
Maximum Input Buffer Size 0
Maximum Output Buffer Size False
Settable Baud Rate True
Settable Data Bits True
Settable Flow Control True
Settable Parity True
Settable Parity Check True
Settable Stop Bits True
Settable RLSD True
Supports RLSD True
Supports 16 Bit Mode False
Supports Special Characters False
Baud Rate 9600
Bits/Byte 8
Stop Bits 1
Parity None
Busy 0
Abort Read/Write on Error 0
Binary Mode Enabled -1
Continue XMit on XOff 0
CTS Outflow Control 0
Discard NULL Bytes 0
DSR Outflow Control 0
DSR Sensitivity 0
DTR Flow Control Type Enable
EOF Character 0
Error Replace Character 0
Error Replacement Enabled 0
Event Character 0
Parity Check Enabled 0
RTS Flow Control Type Enable
XOff Character 19
XOffXMit Threshold 512
XOn Character 17
XOnXMit Threshold 2048
XOnXOff InFlow Control 0
XOnXOff OutFlow Control 0

Appendix C – Tunable Parameters

IRQ Number 3
I/O Port 0x02F8-0x02FF
Driver c:\winnt\system32\drivers\serial.sys (62448, 5.00.2134.1)

[Parallel]

Item Value
Name LPT1
PNP Device ID ACPI\PNP0401\4&14E2F907&0

[Storage]

[Following are sub-categories of this main category]

[Drives]

Item Value
Drive A:
Description 3 1/2 Inch Floppy Drive

Drive C:
Description Local Fixed Disk
Compressed False
File System NTFS
Size 4.24 GB (4,556,771,328 bytes)
Free Space 1008.77 MB (1,057,771,520 bytes)
Volume Name
Volume Serial Number 80E2C477
Partition Disk #0, Partition #0
Partition Size 4.24 GB (4,556,772,864 bytes)
Starting Offset 32256 bytes
Drive Description Disk drive
Drive Manufacturer (Standard disk drives)
Drive Model QUANTUM VIKING II 4.5WLS SCSI Disk Device
Drive BytesPerSector 512
Drive MediaLoaded True
Drive MediaType Fixed hard disk media
Drive Partitions 1
Drive SCSI Bus 0
Drive SCSI Logical Unit 0
Drive SCSI Port 2
Drive SCSI Target Id 2
Drive SectorsPerTrack 63
Drive Size 4556805120 bytes
Drive TotalCylinders 554
Drive TotalSectors 8900010
Drive TotalTracks 141270
Drive TracksPerCylinder 255

[SCSI]

Item Value

Appendix C – Tunable Parameters

Name Adaptec AIC-7899 Ultra160/m PCI SCSI Card
Caption Adaptec AIC-7899 Ultra160/m PCI SCSI Card
Driver adpu160m
Status OK
PNP Device ID PCI\VEN_9005&DEV_00CF&SUBSYS_00CE1028&REV_01\3&1070020&0&10
Device ID PCI\VEN_9005&DEV_00CF&SUBSYS_00CE1028&REV_01\3&1070020&0&10
Device Map Not Available
Index Not Available
Max Number Controlled Not Available
IRQ Number 30
I/O Port 0xDC00-0xDCFF
Driver c:\winnt\system32\drivers\adpu160m.sys (64432, v3.10a)

Name Adaptec AIC-7899 Ultra160/m PCI SCSI Card
Caption Adaptec AIC-7899 Ultra160/m PCI SCSI Card
Driver adpu160m
Status OK
PNP Device ID PCI\VEN_9005&DEV_00CF&SUBSYS_00CE1028&REV_01\3&1070020&0&11
Device ID PCI\VEN_9005&DEV_00CF&SUBSYS_00CE1028&REV_01\3&1070020&0&11
Device Map Not Available
Index Not Available
Max Number Controlled Not Available
IRQ Number 31
I/O Port 0xD800-0xD8FF
Driver c:\winnt\system32\drivers\adpu160m.sys (64432, v3.10a)

[Printing]

Name Port Name Server Name
No printing information

[Problem Devices]

Device PNP Device ID Error Code
Intel 8255x-based PCI Ethernet Adapter (10/100)
PCI\VEN_8086&DEV_1229&SUBSYS_009B1028&REV_08\3&13C0B0C5&0&1022
cLAN Host Adapter
PCI\VEN_135B&DEV_0001&SUBSYS_00000000&REV_00\3&1070020&0&20 22

[USB]

Device PNP Device ID
No USB Devices

[Software Environment]

[Following are sub-categories of this main category]

[Drivers]

Name	Description	File	Type	Started	Start Mode	State	Status	Error Control
abiosdsk	Accept Pause	Abiosdsk	Accept Stop	Not Available	Kernel Driver	False	Disabled	
	Stopped	OK	Ignore	False	False			

Dell 234 DEC 14, 2001
TPC-C Full Disclosure Report
Copyright Dell

Appendix C – Tunable Parameters

abp480n5	abp480n5	Not Available	Kernel Driver	False	Disabled		
	Stopped	OK	Normal	False	False		
acpi	Microsoft ACPI Driver	c:\winnt\system32\drivers\acpi.sys	Kernel Driver	True			
	Boot	Running	OK	Normal	False	True	
acpiec	ACPIEC	c:\winnt\system32\drivers\acpiec.sys	Kernel Driver	False			
	Disabled	Stopped	OK	Normal	False	False	
adpu160m	adpu160m	c:\winnt\system32\drivers\adpu160m.sys	Kernel Driver				
	True	Boot	Running	OK	Normal	False	True
afd	AFD Networking Support Environment	c:\winnt\system32\drivers\afd.sys	Kernel				
Driver	True	Auto	Running	OK	Normal	False	True
aha154x	Aha154x	Not Available	Kernel Driver	False	Disabled		
	Stopped	OK	Normal	False	False		
aic116xaic116x	Not Available	Kernel Driver	False	Disabled	Stopped	OK	
	Normal	False	False				
aic78u2aic78u2	Not Available	Kernel Driver	False	Disabled	Stopped	OK	
	Normal	False	False				
aic78xxaic78xx	Not Available	Kernel Driver	False	Disabled	Stopped	OK	
	Normal	False	False				
ami0nt	ami0nt	Not Available	Kernel Driver	False	Disabled	Stopped	OK
	Normal	False	False				
amsint	amsint	Not Available	Kernel Driver	False	Disabled	Stopped	OK
	Normal	False	False				
asc	asc	Not Available	Kernel Driver	False	Disabled	Stopped	OK
	Normal	False	False				
asc3350p	asc3350p	Not Available	Kernel Driver	False	Disabled		
	Stopped	OK	Normal	False	False		
asc3550	asc3550	Not Available	Kernel Driver	False	Disabled		
	Stopped	OK	Normal	False	False		
asynmac	RAS Asynchronous Media Driver	c:\winnt\system32\drivers\asynmac.sys	Kernel Driver	False	Manual	Stopped	OK
	Kernel Driver	False	Manual	Stopped	OK	Normal	False
atapi	Standard IDE/ESDI Hard Disk Controller	c:\winnt\system32\drivers\atapi.sys	Kernel				
Driver	True	Boot	Running	OK	Normal	False	True
atdisk	Atdisk	Not Available	Kernel Driver	False	Disabled	Stopped	OK
	Ignore	False	False				
atirage3	atirage3	c:\winnt\system32\drivers\atimpab.sys	Kernel Driver	True			
	Manual	Running	OK	Ignore	False	True	
atmarpc	ATM ARP Client Protocol	c:\winnt\system32\drivers\atmarpc.sys	Kernel				
Driver	False	Manual	Stopped	OK	Normal	False	False
audstub	Audio Stub Driver	c:\winnt\system32\drivers\audstub.sys	Kernel Driver	True			
	Manual	Running	OK	Normal	False	True	
beep	Beep	c:\winnt\system32\drivers\beep.sys	Kernel Driver	True	System		
	Running	OK	Normal	False	True		
buslogic	BusLogic	Not Available	Kernel Driver	False	Disabled		
	Stopped	OK	Normal	False	False		
cd20xrnt	cd20xrnt	Not Available	Kernel Driver	False	Disabled		
	Stopped	OK	Normal	False	False		
cdaudio	Cdaudio	c:\winnt\system32\drivers\cdaudio.sys	Kernel Driver	False	System		
	Stopped	OK	Ignore	False	False		
cdfs	Cdfs	c:\winnt\system32\drivers\cdfs.sys	File System Driver	True			
	Disabled	Running	OK	Normal	False	True	
cdrom	CD-ROM Driver	c:\winnt\system32\drivers\cdrom.sys	Kernel Driver	True	System		
	Running	OK	Normal	False	True		
changer	Changer	Not Available	Kernel Driver	False	System	Stopped	
	OK	Ignore	False	False			

Appendix C – Tunable Parameters

cpqarray	Cpqarray	Not Available	Kernel Driver	False	Disabled		
	Stopped	OK	Normal	False	False		
cpqarray2	cpqarray2	Not Available	Kernel Driver	False	Disabled		
	Stopped	OK	Normal	False	False		
cpqfcalm	cpqfcalm	Not Available	Kernel Driver	False	Disabled		
	Stopped	OK	Normal	False	False		
cpqfws2e	cpqfws2e	Not Available	Kernel Driver	False	Disabled		
	Stopped	OK	Normal	False	False		
dac960nt	dac960nt	Not Available	Kernel Driver	False	Disabled		
	Stopped	OK	Normal	False	False		
deckzpsx	deckzpsx	Not Available	Kernel Driver	False	Disabled		
	Stopped	OK	Normal	False	False		
dfsdriver	DfsDriver	c:\winnt\system32\drivers\dfs.sys			File System Driver		
	True	Boot	Running	OK	Normal	False	True
disk	Disk Driver	c:\winnt\system32\drivers\disk.sys			Kernel Driver	True	Boot
	Running	OK	Normal	False	True		
diskperf	Diskperf	c:\winnt\system32\drivers\diskperf.sys			Kernel Driver	True	Boot
	Running	OK	Normal	False	True		
dmboot	dmboot	c:\winnt\system32\drivers\dmboot.sys			Kernel Driver	False	Disabled
	Stopped	OK	Normal	False	False		
dmio	Logical Disk Manager Driver	c:\winnt\system32\drivers\dmio.sys			Kernel Driver		
	True	Boot	Running	OK	Normal	False	True
dmload	dmload	c:\winnt\system32\drivers\dmload.sys			Kernel Driver	True	Boot
	Running	OK	Normal	False	True		
e100b	Intel PRO Adapter Driver	c:\winnt\system32\drivers\e100bnt5.sys			Kernel Driver		
	True	Manual	Running	OK	Normal	False	True
efs	EFS	c:\winnt\system32\drivers\efs.sys			File System Driver	True	
	Disabled	Running	OK	Normal	False	True	
fastfat	Fastfat	c:\winnt\system32\drivers\fastfat.sys			File System Driver	True	
	Disabled	Running	OK	Normal	False	True	
fd16_700	Fd16_700	Not Available	Kernel Driver	False	Disabled		
	Stopped	OK	Normal	False	False		
fdc	Floppy Disk Controller Driver	c:\winnt\system32\drivers\fdc.sys			Kernel Driver		
	True	Manual	Running	OK	Normal	False	True
fireport	fireport	Not Available	Kernel Driver	False	Disabled	Stopped	OK
	Normal	False	False				
flashpnt	flashpnt	Not Available	Kernel Driver	False	Disabled	Stopped	OK
	Normal	False	False				
flpydisk	Floppy Disk Driver	c:\winnt\system32\drivers\flpydisk.sys			Kernel Driver	True	
	Manual	Running	OK	Normal	False	True	
ftdisk	Volume Manager Driver	c:\winnt\system32\drivers\ftdisk.sys			Kernel Driver	True	
	Boot	Running	OK	Normal	False	True	
gnindis	cLAN NDIS Driver	c:\winnt\system32\drivers\gnindis.sys			Kernel Driver	False	
	Auto	Stopped	OK	Normal	False	False	
gnivia	cLAN VIA Driver	c:\winnt\system32\drivers\gnivia.sys			Kernel Driver	True	
	Auto	Running	OK	Normal	False	True	
gpc	Generic Packet Classifier	c:\winnt\system32\drivers\msgpc.sys			Kernel Driver		
	True	Manual	Running	OK	Normal	False	True
i8042prt	i8042 Keyboard and PS/2 Mouse Port Driver	c:\winnt\system32\drivers\i8042prt.sys			Kernel Driver	True	System Running
	OK	Normal	False	True			
ini910u	ini910u	Not Available	Kernel Driver	False	Disabled	Stopped	OK
	Normal	False	False				
intelide	Intellde	Not Available	Kernel Driver	False	Disabled	Stopped	OK
	Normal	False	False				

Appendix C – Tunable Parameters

ipfilterdriver	IP Traffic Filter Driver	c:\winnt\system32\drivers\ipfltdrv.sys	Kernel Driver					
	False	Manual Stopped	OK	Normal	False	False		
ipinip	IP in IP Tunnel Driver	c:\winnt\system32\drivers\ipinip.sys	Kernel Driver	False				
	Manual Stopped	OK	Normal	False	False			
ipnat	IP Network Address Translator	c:\winnt\system32\drivers\ipnat.sys	Kernel Driver					
	False	Manual Stopped	OK	Normal	False	False		
ipsec	IPSEC driver	c:\winnt\system32\drivers\ipsec.sys	Kernel Driver	False	Manual			
	Stopped	OK	Normal	False	False			
ipsraidn	ipsraidn	Not Available	Kernel Driver	False	Disabled	Stopped	OK	
	Normal	False	False					
isapnp	PnP ISA/EISA Bus Driver	c:\winnt\system32\drivers\isapnp.sys	Kernel Driver					
	True	Boot Running	OK	Critical	False	True		
kbdclass	Keyboard Class Driver	c:\winnt\system32\drivers\kbdclass.sys	Kernel Driver					
	True	System Running	OK	Normal	False	True		
ksecdd	KSecDD	c:\winnt\system32\drivers\ksecdd.sys	Kernel Driver	True	Boot			
	Running	OK	Normal	False	True			
lbrtfdc	lbrtfdc	Not Available	Kernel Driver	False	System Stopped	OK	Ignore	
	False	False						
lp6nds35	lp6nds35	Not Available	Kernel Driver	False	Disabled			
	Stopped	OK	Normal	False	False			
mnmd	mnmd	c:\winnt\system32\drivers\mnmd.sys	Kernel Driver	True	System			
	Running	OK	Ignore	False	True			
modem	Modem	c:\winnt\system32\drivers\modem.sys	Kernel Driver	False	Manual			
	Stopped	OK	Ignore	False	False			
mouclass	Mouse Class Driver	c:\winnt\system32\drivers\mouclass.sys	Kernel Driver					
	True	System Running	OK	Normal	False	True		
mountmgr	MountMgr	c:\winnt\system32\drivers\mountmgr.sys	Kernel Driver	True				
	Boot	Running	OK	Normal	False	True		
mraid35x	mraid35x	Not Available	Kernel Driver	False	Disabled			
	Stopped	OK	Normal	False	False			
mrxsm	MRXSMB	c:\winnt\system32\drivers\mrxsm.sys	File System Driver	True				
	System Running	OK	Normal	False	True			
msfs	Msfs	c:\winnt\system32\drivers\msfs.sys	File System Driver	True	System			
	Running	OK	Normal	False	True			
mksrv	Microsoft Streaming Service Proxy	c:\winnt\system32\drivers\mksrv.sys	Kernel Driver	False	Manual Stopped	OK	Normal	False
	Kernel Driver	False	Manual Stopped	OK	Normal	False	False	
mspclock	Microsoft Streaming Clock Proxy	c:\winnt\system32\drivers\mspclock.sys	Kernel Driver	False	Manual Stopped	OK	Normal	False
	Kernel Driver	False	Manual Stopped	OK	Normal	False	False	
mspqm	Microsoft Streaming Quality Manager Proxy	c:\winnt\system32\drivers\mspqm.sys	Kernel Driver	False	Manual Stopped	OK	Normal	False
	Kernel Driver	False	Manual Stopped	OK	Normal	False	False	
mup	Mup	c:\winnt\system32\drivers\mup.sys	File System Driver	True	Boot			
	Running	OK	Normal	False	True			
ncrc710	Nrc710	Not Available	Kernel Driver	False	Disabled	Stopped		
	OK	Normal	False	False				
ndis	NDIS System Driver	c:\winnt\system32\drivers\ndis.sys	Kernel Driver	True				
	Boot	Running	OK	Normal	False	True		
ndistapi	Remote Access NDIS TAPI Driver	c:\winnt\system32\drivers\ndistapi.sys	Kernel Driver	True	Manual Running	OK	Normal	False
	Driver	True	Manual Running	OK	Normal	False	True	
ndiswan	Remote Access NDIS WAN Driver	c:\winnt\system32\drivers\ndiswan.sys	Kernel Driver	True	Manual Running	OK	Normal	False
	Kernel Driver	True	Manual Running	OK	Normal	False	True	
ndproxy	NDIS Proxy	c:\winnt\system32\drivers\ndproxy.sys	Kernel Driver	True	Manual			
	Running	OK	Normal	False	True			
netbios	NetBIOS Interface	c:\winnt\system32\drivers\netbios.sys	File System Driver					
	True	System Running	OK	Normal	False	True		

Appendix C – Tunable Parameters

netbt	NetBios over Tcpip	c:\winnt\system32\drivers\netbt.sys	Kernel Driver	True			
	System Running	OK	Normal	False	True		
netdetect	NetDetect	c:\winnt\system32\drivers\netdect.sys	Kernel Driver	False			
	Manual Stopped	OK	Normal	False	False		
npfs	Npfs	c:\winnt\system32\drivers\npfs.sys	File System Driver	True	System		
	Running	OK	Normal	False	True		
ntfs	Ntfs	c:\winnt\system32\drivers\ntfs.sys	File System Driver	True			
	Disabled	Running	OK	Normal	False	True	
null	Null	c:\winnt\system32\drivers\null.sys	Kernel Driver	True	System		
	Running	OK	Normal	False	True		
nwlnkflt	IPX Traffic Filter Driver	c:\winnt\system32\drivers\nwlnkflt.sys	Kernel Driver	False			
	Manual Stopped	OK	Normal	False	False		
nwlnkfld	IPX Traffic Forwarder Driver	c:\winnt\system32\drivers\nwlnkfld.sys	Kernel Driver	False			
	Manual Stopped	OK	Normal	False	False		
openhci	Microsoft USB Open Host Controller Driver	c:\winnt\system32\drivers\openhci.sys	Kernel Driver	False			
	Manual Stopped	OK	Normal	False	False		
parallel	Parallel class driver	c:\winnt\system32\drivers\parallel.sys	Kernel Driver	True			
	Manual Running	OK	Normal	False	True		
parport	Parallel port driver	c:\winnt\system32\drivers\parport.sys	Kernel Driver	True			
	System Running	OK	Ignore	False	True		
partmgr	PartMgr	c:\winnt\system32\drivers\partmgr.sys	Kernel Driver	True	Boot		
	Running	OK	Normal	False	True		
parvdm	ParVdm	c:\winnt\system32\drivers\parvdm.sys	Kernel Driver	True	Auto		
	Running	OK	Ignore	False	True		
pci	PCI Bus Driver	c:\winnt\system32\drivers\pci.sys	Kernel Driver	True	Boot		
	Running	OK	Critical	False	True		
pcidump	PCIDump	Not Available	Kernel Driver	False	System Stopped		
	OK	Ignore	False	False			
pciide	PCIIde	c:\winnt\system32\drivers\pciide.sys	Kernel Driver	True	Boot		
	Running	OK	Normal	False	True		
pcmcia	Pcmcia	c:\winnt\system32\drivers\pcmcia.sys	Kernel Driver	False	Disabled		
	Stopped	OK	Normal	False	False		
pdcomp	PDCOMP	Not Available	Kernel Driver	False	Manual Stopped	OK	
	Ignore	False	False				
pdframe	PDFRAME	Not Available	Kernel Driver	False	Manual Stopped		
	OK	Ignore	False	False			
pdreli	PDRELI	Not Available	Kernel Driver	False	Manual Stopped	OK	
	Ignore	False	False				
pdframe	PDRFRAME	Not Available	Kernel Driver	False	Manual Stopped		
	OK	Ignore	False	False			
pptpminiport	WAN Miniport (PPTP)	c:\winnt\system32\drivers\raspttp.sys	Kernel Driver	True			
	Manual Running	OK	Normal	False	True		
ptilink	Direct Parallel Link Driver	c:\winnt\system32\drivers\ptilink.sys	Kernel Driver	True			
	Manual Running	OK	Normal	False	True		
ql1080	ql1080	Not Available	Kernel Driver	False	Disabled	Stopped	OK
	Normal	False	False				
ql10wnt	QL10wnt	Not Available	Kernel Driver	False	Disabled	Stopped	
	OK	Normal	False	False			
ql1240	ql1240	Not Available	Kernel Driver	False	Disabled	Stopped	OK
	Normal	False	False				
ql2100	ql2100	Not Available	Kernel Driver	False	Disabled	Stopped	OK
	Normal	False	False				
rasacd	Remote Access Auto Connection Driver	c:\winnt\system32\drivers\rasacd.sys	Kernel Driver	True			
	System Running	OK	Normal	False	True		

Appendix C – Tunable Parameters

rasl2tp	WAN Miniport (L2TP)	c:\winnt\system32\drivers\rasl2tp.sys	Kernel Driver	True			
	Manual Running	OK	Normal	False	True		
raspti	Direct Parallel	c:\winnt\system32\drivers\raspti.sys	Kernel Driver	True	Manual		
	Running	OK	Normal	False	True		
rca	Microsoft Streaming Network Raw Channel Access	c:\winnt\system32\drivers\rca.sys	Kernel Driver	False	Manual	Stopped	
	OK	Normal	False	False			
rdbss	Rdbss	c:\winnt\system32\drivers\rdbss.sys	File System Driver	True	System		
	Running	OK	Normal	False	True		
rdpwd	RDPWD	c:\winnt\system32\drivers\rdpwd.sys	Kernel Driver	False	Manual		
	Stopped	OK	Ignore	False	False		
redbook	Digital CD Audio Playback Filter Driver	c:\winnt\system32\drivers\redbook.sys	Kernel Driver	False	System	Stopped	
	Kernel Driver	False	System	Stopped	OK	Normal	False
serenum	Serenum Filter Driver	c:\winnt\system32\drivers\serenum.sys	Kernel Driver	True	Manual	Running	
	True	Manual	Running	OK	Normal	False	True
serial	Serial port driver	c:\winnt\system32\drivers\serial.sys	Kernel Driver	True			
	System Running	OK	Ignore	False	True		
sfloppy	Sfloppy	c:\winnt\system32\drivers\sfloppy.sys	Kernel Driver	False	System		
	Stopped	OK	Ignore	False	False		
sglfb	sglfb	Not Available	Kernel Driver	False	System	Stopped	OK
	False	False					Normal
simbad	Simbad	Not Available	Kernel Driver	False	Disabled	Stopped	OK
	Normal	False	False				
sparrow	Sparrow	Not Available	Kernel Driver	False	Disabled	Stopped	
	OK	Normal	False	False			
spud	Special Purpose Utility Driver	c:\winnt\system32\drivers\spud.sys	Kernel Driver	True	Manual	Running	
	True	Manual	Running	OK	Normal	False	True
srv	Srv	c:\winnt\system32\drivers\srv.sys	File System Driver	True	Manual		
	Running	OK	Normal	False	True		
swenum	Software Bus Driver	c:\winnt\system32\drivers\swenum.sys	Kernel Driver	True	Manual	Running	
	True	Manual	Running	OK	Normal	False	True
symc810	symc810	Not Available	Kernel Driver	False	Disabled		
	Stopped	OK	Normal	False	False		
symc8xx	symc8xx	Not Available	Kernel Driver	False	Disabled		
	Stopped	OK	Normal	False	False		
sym_hi	sym_hi	Not Available	Kernel Driver	False	Disabled	Stopped	OK
	Normal	False	False				
tcpip	TCP/IP Protocol Driver	c:\winnt\system32\drivers\tcpip.sys	Kernel Driver	True			
	System Running	OK	Normal	False	True		
tdasync	TDASYNC	c:\winnt\system32\drivers\tdasync.sys	Kernel Driver	False	Manual		
	Stopped	OK	Ignore	False	False		
tdipx	TDIPX	c:\winnt\system32\drivers\tdipx.sys	Kernel Driver	False	Manual		
	Stopped	OK	Ignore	False	False		
tdnetb	TDNETB	c:\winnt\system32\drivers\tdnetb.sys	Kernel Driver	False	Manual		
	Stopped	OK	Ignore	False	False		
tdpipe	TDPIPE	c:\winnt\system32\drivers\tdpipe.sys	Kernel Driver	False	Manual		
	Stopped	OK	Ignore	False	False		
tdspix	TDSPX	c:\winnt\system32\drivers\tdspix.sys	Kernel Driver	False	Manual		
	Stopped	OK	Ignore	False	False		
tdtcp	TDTCP	c:\winnt\system32\drivers\tdtcp.sys	Kernel Driver	False	Manual		
	Stopped	OK	Ignore	False	False		
termdd	Terminal Device Driver	c:\winnt\system32\drivers\termdd.sys	Kernel Driver	False			
	Disabled	Stopped	OK	Normal	False	False	
tga	tga	Not Available	Kernel Driver	False	System	Stopped	OK
	False	False					Ignore

Appendix C – Tunable Parameters

udfs	Udfs	c:\winnt\system32\drivers\udfs.sys	File System Driver	False				
	Disabled	Stopped	OK	Normal	False	False		
ultra66	ultra66	Not Available	Kernel Driver	False	Disabled	Stopped	OK	
	Normal	False	False					
update	Microcode Update Driver	c:\winnt\system32\drivers\update.sys	Kernel Driver					
	True	Manual Running	OK	Normal	False	True		
usbhub	Microsoft USB Standard Hub Driver	c:\winnt\system32\drivers\usbhub.sys	Kernel Driver					
Driver	False	Manual Stopped	OK	Normal	False	False		
vgasave	VgaSave	c:\winnt\system32\drivers\vga.sys	Kernel Driver	True				
	System Running	OK	Ignore	False	True			
wanarp	Remote Access IP ARP Driver	c:\winnt\system32\drivers\wanarp.sys	Kernel Driver					
	True	Manual Running	OK	Normal	False	True		
wdica	WDICA	Not Available	Kernel Driver	False	Manual	Stopped	OK	Ignore
	False	False						

[Environment Variables]

Variable	Value	User Name
ComSpec	%SystemRoot%\system32\cmd.exe	<SYSTEM>
NUMBER_OF_PROCESSORS	1	<SYSTEM>
OS	Windows_NT	<SYSTEM>
Os2LibPath	%SystemRoot%\system32\os2\dll;	<SYSTEM>
Path	C:\MKS\mksnt;C:\WINNT\system32;C:\WINNT;C:\WINNT\System32\Wbem;C:\Program Files\Microsoft SQL Server\80\Tools\BINN;C:\SQL_2K~1\x86\bin\.;	<SYSTEM>
PATHEXT	.COM;.EXE;.BAT;.CMD;.VBS;.VBE;.JS;.JSE;.WSF;.WSH	<SYSTEM>
PROCESSOR_ARCHITECTURE	x86	<SYSTEM>
PROCESSOR_IDENTIFIER	x86 Family 6 Model 8 Stepping 6, GenuineIntel	<SYSTEM>
PROCESSOR_LEVEL	6	<SYSTEM>
PROCESSOR_REVISION	0806	<SYSTEM>
TEMP	%SystemRoot%\TEMP	<SYSTEM>
TMP	%SystemRoot%\TEMP	<SYSTEM>
windir	%SystemRoot%	<SYSTEM>
ROOTDIR	C:/MKS	<SYSTEM>
SHELL	C:/MKS/mksnt/sh.exe	<SYSTEM>
HOME	C:/	<SYSTEM>
TMPDIR	C:/WINNT/TEMP	<SYSTEM>
TEMP	%USERPROFILE%\Local Settings\Temp	CLIENT3\Administrator
TMP	%USERPROFILE%\Local Settings\Temp	CLIENT3\Administrator

[Jobs]

[Following are sub-categories of this main category]

[Print]

Document	Size	Owner	Notify	Status	Time Submitted	Start Time	Until Time
Elapsed Time	Pages Printed	Job ID	Priority	Parameters	Driver Name	Print	
Processor	Host Print Queue	Data Type	Name				
Unknown	Unknown	Unknown	Unknown	Unknown	Unknown	Unknown	Unknown
	Unknown	Unknown	Unknown	Unknown	Unknown	Unknown	
	Unknown	Unknown	Unknown	Unknown	Unknown	Unknown	
	Unknown	Unknown					

[Network Connections]

Appendix C – Tunable Parameters

Local Name Remote Name Type Status User Name
 No network connections information

[Running Tasks]

Name	Path	Process ID	Priority	Min Working Set	Max Working Set	Start
system idle process		Not Available	0	0	Not Available	Not Available
Available		Unknown	Unknown	Unknown		
system	Not Available	8	8	0	1413120	Not Available
	Unknown	Unknown				Unknown
smss.exe	c:\winnt\system32\smss.exe			160	11	204800 1413120
	10/16/2001 3:47:16 PM	5.00.2170.1		44.27 KB (45,328 bytes)		12/7/1999 6:00:00 AM
csrss.exe		Not Available	184	13	Not Available	Not Available
3:47:22 PM	Unknown	Unknown		Unknown		10/16/2001
winlogon.exe	c:\winnt\system32\winlogon.exe			204	13	204800 1413120
	10/16/2001 3:47:24 PM	5.00.2182.1		173.27 KB (177,424 bytes)		12/7/1999
6:00:00 AM						
services.exe	c:\winnt\system32\services.exe			232	9	204800 1413120
	10/16/2001 3:47:25 PM	5.00.2134.1		86.77 KB (88,848 bytes)		12/7/1999 6:00:00 AM
lsass.exe	c:\winnt\system32\lsass.exe			244	13	204800 1413120
	10/16/2001 3:47:25 PM	5.00.2184.1		32.77 KB (33,552 bytes)		12/7/1999 6:00:00 AM
gnconmgr.exe	c:\winnt\system32\gnconmgr.exe			380	8	204800 1413120
	10/16/2001 3:47:29 PM	4.2.0.23		140.06 KB (143,420 bytes)		2/20/2001
11:50:27 AM						
svchost.exe	c:\winnt\system32\svchost.exe			408	8	204800 1413120
	10/16/2001 3:47:30 PM	5.00.2134.1		7.77 KB (7,952 bytes)		12/7/1999 6:00:00 AM
msdtc.exe	c:\winnt\system32\msdtc.exe			432	8	204800 1413120
	10/16/2001 3:47:31 PM	1999.9.3421.3		6.77 KB (6,928 bytes)		2/16/2001 5:17:10 AM
svchost.exe	c:\winnt\system32\svchost.exe			544	8	204800 1413120
	10/16/2001 3:47:34 PM	5.00.2134.1		7.77 KB (7,952 bytes)		12/7/1999 6:00:00 AM
tcpsvcs.exe	c:\winnt\system32\tcpsvcs.exe			576	8	204800 1413120
	10/16/2001 3:47:35 PM	5.00.2134.1		24.77 KB (25,360 bytes)		12/7/1999 6:00:00 AM
winmgmt.exe	c:\winnt\system32\wbem\winmgmt.exe			588	8	204800 1413120
	10/16/2001 3:47:35 PM	1.50.1085.0001		188.05 KB (192,567 bytes)		12/7/1999
6:00:00 AM						
inetinfo.exe	c:\winnt\system32\inetrv\inetinfo.exe			616	8	204800 1413120
	10/16/2001 3:47:36 PM	5.00.0984		14.27 KB (14,608 bytes)		2/16/2001 5:17:51 AM
explorer.exe	c:\winnt\explorer.exe			704	8	204800 1413120
3:47:44 PM		5.00.2920.0000		232.77 KB (238,352 bytes)		12/7/1999 6:00:00 AM
dfssvc.exe	c:\winnt\system32\dfssvc.exe			596	8	204800 1413120
	10/16/2001 3:47:44 PM	5.00.2191.1		85.27 KB (87,312 bytes)		12/7/1999 6:00:00 AM
dllhost.exe		Not Available	1044	8	Not Available	Not Available
3:48:06 PM	Unknown	Unknown		Unknown		10/16/2001
svchost.exe	c:\winnt\system32\svchost.exe			1148	8	204800 1413120
	10/16/2001 3:48:10 PM	5.00.2134.1		7.77 KB (7,952 bytes)		12/7/1999 6:00:00 AM
dllhost.exe		Not Available	1276	8	Not Available	Not Available
3:48:13 PM	Unknown	Unknown		Unknown		10/16/2001
sh.exe	c:\mks\mksnt\sh.exe			1164	8	204800 1413120
	5.2 build 64			271.50 KB (278,016 bytes)		2/16/2001 4:08:14 PM
mmc.exe	c:\winnt\system32\mmc.exe			312	8	204800 1413120
	10/16/2001 4:29:09 PM	5.00.2153.1		589.27 KB (603,408 bytes)		12/7/1999
6:00:00 AM						

Appendix C – Tunable Parameters

rsvp.exe c:\winnt\system32\rsvp.exe 2036 8 204800 1413120
 10/16/2001 4:30:07 PM 5.00.2167.1 172.77 KB (176,912 bytes) 12/7/1999
 6:00:00 AM

[Loaded Modules]

Name	Version	Size	File Date	Manufacturer	Path
traffic.dll	5.00.2139.1	30.77 KB (31,504 bytes)	12/7/1999 6:00:00 AM	Microsoft Corporation	c:\winnt\system32\traffic.dll
rsvp.exe	5.00.2167.1	172.77 KB (176,912 bytes)	12/7/1999 6:00:00 AM	Microsoft Corporation	c:\winnt\system32\rsvp.exe
wbemprox.dll	1.50.1085.000140.05	140.05 KB (41,016 bytes)	12/7/1999 6:00:00 AM	Microsoft Corporation	c:\winnt\system32\wbem\wbemprox.dll
mlang.dll	5.00.2920.0000510.77	107.77 KB (523,024 bytes)	12/7/1999 6:00:00 AM	Microsoft Corporation	c:\winnt\system32\mlang.dll
rassapi.dll	5.00.2188.1	14.27 KB (14,608 bytes)	12/7/1999 6:00:00 AM	Microsoft Corporation	c:\winnt\system32\rassapi.dll
adsnt.dll	5.00.2191.1	194.27 KB (198,928 bytes)	12/7/1999 6:00:00 AM	Microsoft Corporation	c:\winnt\system32\adsnt.dll
dbghelp.dll	5.00.2195.1	159.27 KB (163,088 bytes)	12/7/1999 6:00:00 AM	Microsoft Corporation	c:\winnt\system32\dbghelp.dll
localesec.dll	5.00.2134.1	227.27 KB (232,720 bytes)	12/7/1999 6:00:00 AM	Microsoft Corporation	c:\winnt\system32\localesec.dll
devmgr.dll	5.00.2166.1	215.77 KB (220,944 bytes)	12/7/1999 6:00:00 AM	Microsoft Corporation	c:\winnt\system32\devmgr.dll
filemgmt.dll	5.00.2134.1	287.27 KB (294,160 bytes)	12/7/1999 6:00:00 AM	Microsoft Corporation	c:\winnt\system32\filemgmt.dll
pdh.dll	5.00.2174.1	143.27 KB (146,704 bytes)	12/7/1999 6:00:00 AM	Microsoft Corporation	c:\winnt\system32\pdh.dll
smlogcfg.dll	5.00.2163.1	273.27 KB (279,824 bytes)	12/7/1999 6:00:00 AM	Microsoft Corporation	c:\winnt\system32\smlogcfg.dll
cabinet.dll	5.00.2147.1	54.77 KB (56,080 bytes)	12/7/1999 6:00:00 AM	Microsoft Corporation	c:\winnt\system32\cabinet.dll
msinfo32.dll	5.00.2177.1	312.27 KB (319,760 bytes)	2/16/2001 11:23:04 AM	Microsoft Corporation	c:\program files\common files\microsoft shared\msinfo\msinfo32.dll
riched20.dll	5.30.23.1200	421.27 KB (431,376 bytes)	12/7/1999 6:00:00 AM	Microsoft Corporation	c:\winnt\system32\riched20.dll
riched32.dll	5.00.2134.1	3.77 KB (3,856 bytes)	12/7/1999 6:00:00 AM	Microsoft Corporation	c:\winnt\system32\riched32.dll
els.dll	5.00.2175.1	151.27 KB (154,896 bytes)	12/7/1999 6:00:00 AM	Microsoft Corporation	c:\winnt\system32\els.dll
ntsmgr.dll	1,0,0,1	427.77 KB (438,032 bytes)	12/7/1999 6:00:00 AM	Microsoft Corporation and HighGround Systems, Inc.	c:\winnt\system32\ntsmgr.dll
mmfutil.dll	1.50.1085.000032.06	32.06 KB (32,829 bytes)	12/7/1999 6:00:00 AM	Microsoft Corporation	c:\winnt\system32\mmfutil.dll
logdrive.dll	1.50.1085.0000200.06	200.06 KB (204,863 bytes)	12/7/1999 6:00:00 AM	Microsoft Corporation	c:\winnt\system32\logdrive.dll
dfrgres.dll	5.00.2150.1	27.50 KB (28,160 bytes)	12/7/1999 6:00:00 AM	Executive Software International, Inc.	c:\winnt\system32\dfrgres.dll
dfrgsnap.dll	5.00.2150.1	41.77 KB (42,768 bytes)	12/7/1999 6:00:00 AM	Executive Software International, Inc.	c:\winnt\system32\dfrgsnap.dll
dmdskres.dll	2191.1.296.2	119.00 KB (121,856 bytes)	12/7/1999 6:00:00 AM	Microsoft Corp., VERITAS Software	c:\winnt\system32\dmdskres.dll

Appendix C – Tunable Parameters

dmutil.dll	2191.1.296.2	41.77 KB (42,768 bytes)	12/7/1999 6:00:00 AM	VERITAS Software Corp.	c:\winnt\system32\dmutil.dll
ntmsapi.dll	5.00.1948.1	50.27 KB (51,472 bytes)	12/7/1999 6:00:00 AM	Microsoft Corporation	c:\winnt\system32\ntmsapi.dll
dmdskmgr.dll	2191.1.296.2	158.77 KB (162,576 bytes)	12/7/1999 6:00:00 AM	Microsoft Corp., VERITAS Software	c:\winnt\system32\dmdskmgr.dll
mycomput.dll	5.00.2134.1	107.77 KB (110,352 bytes)	12/7/1999 6:00:00 AM	Microsoft Corporation	c:\winnt\system32\mycomput.dll
mmcndmgr.dll	5.00.2178.1	815.27 KB (834,832 bytes)	12/7/1999 6:00:00 AM	Microsoft Corporation	c:\winnt\system32\mmcndmgr.dll
mfc42u.dll	6.00.8665.0	972.05 KB (995,384 bytes)	12/7/1999 6:00:00 AM	Microsoft Corporation	c:\winnt\system32\mfc42u.dll
mmc.exe	5.00.2153.1	589.27 KB (603,408 bytes)	12/7/1999 6:00:00 AM	Microsoft Corporation	c:\winnt\system32\mmc.exe
sh.exe	5.2 build 64	271.50 KB (278,016 bytes)	2/16/2001 4:08:14 PM	Mortice Kern Systems Inc.	c:\mks\mksnt\sh.exe
tapisrv.dll	5.00.2186.1	168.77 KB (172,816 bytes)	12/7/1999 6:00:00 AM	Microsoft Corporation	c:\winnt\system32\tapisrv.dll
dfssvc.exe	5.00.2191.1	85.27 KB (87,312 bytes)	12/7/1999 6:00:00 AM	Microsoft Corporation	c:\winnt\system32\dfssvc.exe
wininet.dll	5.00.2920.0000456.77	KB (467,728 bytes)	12/7/1999 6:00:00 AM	Microsoft Corporation	c:\winnt\system32\wininet.dll
shdoclc.dll	5.00.2920.0000324.50	KB (332,288 bytes)	12/7/1999 6:00:00 AM	Microsoft Corporation	c:\winnt\system32\shdoclc.dll
actxprxy.dll	5.00.2920.000070.77	KB (72,464 bytes)	12/7/1999 6:00:00 AM	Microsoft Corporation	c:\winnt\system32\actxprxy.dll
urlmon.dll	5.00.2920.0000426.77	KB (437,008 bytes)	12/7/1999 6:00:00 AM	Microsoft Corporation	c:\winnt\system32\urlmon.dll
faxshell.dll	5.00.2134.1	8.27 KB (8,464 bytes)	12/7/1999 6:00:00 AM	Microsoft Corporation	c:\winnt\system32\faxshell.dll
msacm32.dll	5.00.2134.1	65.27 KB (66,832 bytes)	12/7/1999 6:00:00 AM	Microsoft Corporation	c:\winnt\system32\msacm32.dll
avifil32.dll	5.00.2134.1	76.27 KB (78,096 bytes)	12/7/1999 6:00:00 AM	Microsoft Corporation	c:\winnt\system32\avifil32.dll
msvfw32.dll	5.00.2134.1	113.77 KB (116,496 bytes)	12/7/1999 6:00:00 AM	Microsoft Corporation	c:\winnt\system32\msvfw32.dll
docprop2.dll	5.00.2178.1	297.77 KB (304,912 bytes)	12/7/1999 6:00:00 AM	Microsoft Corporation	c:\winnt\system32\docprop2.dll
ntshrui.dll	5.00.2134.1	46.77 KB (47,888 bytes)	12/7/1999 6:00:00 AM	Microsoft Corporation	c:\winnt\system32\ntshrui.dll
linkinfo.dll	5.00.2134.1	15.77 KB (16,144 bytes)	12/7/1999 6:00:00 AM	Microsoft Corporation	c:\winnt\system32\linkinfo.dll
browselc.dll	5.00.2920.000034.50	KB (35,328 bytes)	12/7/1999 6:00:00 AM	Microsoft Corporation	c:\winnt\system32\browselc.dll
msi.dll	1.10.1029.0	1.71 MB (1,794,320 bytes)	12/7/1999 6:00:00 AM	Microsoft Corporation	c:\winnt\system32\msi.dll
powrprof.dll	5.00.2920.000013.27	KB (13,584 bytes)	12/7/1999 6:00:00 AM	Microsoft Corporation	c:\winnt\system32\powrprof.dll
batmeter.dll	5.00.2920.000020.27	KB (20,752 bytes)	12/7/1999 6:00:00 AM	Microsoft Corporation	c:\winnt\system32\batmeter.dll
stobject.dll	5.00.2144.1	81.77 KB (83,728 bytes)	12/7/1999 6:00:00 AM	Microsoft Corporation	c:\winnt\system32\stobject.dll
webcheck.dll	5.00.2920.0000251.77	KB (257,808 bytes)	12/7/1999 6:00:00 AM	Microsoft Corporation	c:\winnt\system32\webcheck.dll

Appendix C – Tunable Parameters

browseui.dll	5.00.2920.0000793.27 KB (812,304 bytes)	12/7/1999 6:00:00 AM
Microsoft Corporation c:\winnt\system32\browseui.dll		
shdocvw.dll	5.00.2920.00001.05 MB (1,104,144 bytes)	12/7/1999 6:00:00 AM
Microsoft Corporation c:\winnt\system32\shdocvw.dll		
explorer.exe	5.00.2920.0000232.77 KB (238,352 bytes)	12/7/1999 6:00:00 AM
Microsoft Corporation c:\winnt\explorer.exe		
tpcc_com_all.dll	1, 0, 0, 1 80.00 KB (81,920 bytes)	7/2/2001 11:45:41 AM
c:\inetpub\wwwroot\tpcc_c~2.dll		
dbnetlib.dll	2000.080.0194.00 84.06 KB (86,082 bytes)	2/16/2001 3:52:07 PM
Microsoft Corporation c:\winnt\system32\dbnetlib.dll		
ntwdblib.dll	2000.080.0194.00 268.06 KB (274,489 bytes)	2/16/2001 3:52:12 PM
Microsoft Corporation c:\winnt\system32\ntwdblib.dll		
tpcc_dblib.dll	Not Available 28.00 KB (28,672 bytes)	7/2/2001 11:45:39 AM Not Available
c:\inetpub\wwwroot\tpcc_dblib.dll		
tpcc_com.dll	Not Available 24.00 KB (24,576 bytes)	7/2/2001 11:45:40 AM Not Available
c:\inetpub\wwwroot\tpcc_com.dll		
tpcc.dll	0, 4, 0, 0 92.00 KB (94,208 bytes)	7/2/2001 11:45:39 AM Microsoft
c:\inetpub\wwwroot\tpcc.dll		
iwrps.dll	5.00.2182.1 8.77 KB (8,976 bytes)	2/16/2001 5:17:56 AM Microsoft
Corporation c:\winnt\system32\inetsrv\iwrps.dll		
wamps.dll	5.00.2159.1 7.27 KB (7,440 bytes)	2/16/2001 5:17:57 AM Microsoft
Corporation c:\winnt\system32\inetsrv\wamps.dll		
wshom.ocx	5.1.0.4615 72.05 KB (73,776 bytes)	12/7/1999 6:00:00 AM Microsoft
Corporation c:\winnt\system32\wshom.ocx		
wamregps.dll	5.00.2159.1 7.27 KB (7,440 bytes)	2/16/2001 5:17:52 AM Microsoft
Corporation c:\winnt\system32\wamregps.dll		
scrrun.dll	5.1.0.4615 144.05 KB (147,512 bytes)	12/7/1999 6:00:00 AM
Microsoft Corporation c:\winnt\system32\scrrun.dll		
iisext.dll	5.00.2159.1 41.77 KB (42,768 bytes)	2/16/2001 5:17:52 AM Microsoft Corporation
c:\winnt\system32\iisext.dll		
adsiis.dll	5.00.2159.1 238.77 KB (244,496 bytes)	2/16/2001 5:17:52 AM
Microsoft Corporation c:\winnt\system32\adsiis.dll		
vbscript.dll	5.1.0.4615 428.06 KB (438,330 bytes)	12/7/1999 6:00:00 AM
Microsoft Corporation c:\winnt\system32\vbscript.dll		
asptxn.dll	5.00.0954 29.77 KB (30,480 bytes)	2/16/2001 5:17:55 AM Microsoft
Corporation c:\winnt\system32\inetsrv\asptxn.dll		
asp.dll	5.00.0984 326.77 KB (334,608 bytes)	2/16/2001 5:17:55 AM Microsoft
Corporation c:\winnt\system32\inetsrv\asp.dll		
mfc42.dll	6.00.8665.0 972.05 KB (995,383 bytes)	12/7/1999 6:00:00 AM
Microsoft Corporation c:\winnt\system32\mfc42.dll		
wam.dll	5.00.0984 71.27 KB (72,976 bytes)	2/16/2001 5:17:57 AM Microsoft Corporation
c:\winnt\system32\inetsrv\wam.dll		
odbcint.dll	3.520.6526.0 88.00 KB (90,112 bytes)	2/16/2001 3:52:03 PM Microsoft
Corporation c:\winnt\system32\odbcint.dll		
odbc32.dll	3.520.6526.0 216.27 KB (221,456 bytes)	2/16/2001 3:52:03 PM
Microsoft Corporation c:\winnt\system32\odbc32.dll		
comsvcs.dll	1999.9.3422.141.16 MB (1,219,856 bytes)	2/16/2001 5:17:06 AM
Microsoft Corporation c:\winnt\system32\comsvcs.dll		
iislog.dll	5.00.0984 76.27 KB (78,096 bytes)	2/16/2001 5:17:51 AM Microsoft Corporation
c:\winnt\system32\inetsrv\iislog.dll		
ntlsapi.dll	5.00.2134.1 6.77 KB (6,928 bytes)	12/7/1999 6:00:00 AM Microsoft
Corporation c:\winnt\system32\ntlsapi.dll		
httpext.dll	0.9.3939.9 418.27 KB (428,304 bytes)	2/16/2001 5:17:50 AM
Microsoft Corporation c:\winnt\system32\inetsrv\httpext.dll		

Appendix C – Tunable Parameters

rpcproxy.dll	5.00.2176.1	16.27 KB (16,656 bytes)	2/16/2001 5:17:05 AM	Microsoft Corporation	c:\winnt\system32\rpcproxy\rpcproxy.dll
fpexedll.dll	4.0.2.3406	20.06 KB (20,541 bytes)	2/16/2001 5:19:40 AM	Microsoft Corporation	c:\program files\common files\microsoft shared\web server extensions\40\bin\fpexedll.dll
md5filt.dll	5.00.0984	32.77 KB (33,552 bytes)	2/16/2001 5:17:56 AM	Microsoft Corporation	c:\winnt\system32\inetsrv\md5filt.dll
gzip.dll	5.00.0984	30.27 KB (30,992 bytes)	2/16/2001 5:17:56 AM	Microsoft Corporation	c:\winnt\system32\inetsrv\gzip.dll
compfilt.dll	5.00.0984	22.27 KB (22,800 bytes)	2/16/2001 5:17:55 AM	Microsoft Corporation	c:\winnt\system32\inetsrv\compfilt.dll
sspifilt.dll	5.00.0984	43.27 KB (44,304 bytes)	2/16/2001 5:17:57 AM	Microsoft Corporation	c:\winnt\system32\inetsrv\sspifilt.dll
iscomlog.dll	5.00.0984	24.77 KB (25,360 bytes)	2/16/2001 5:17:51 AM	Microsoft Corporation	c:\winnt\system32\inetsrv\iscomlog.dll
lonsint.dll	5.00.0984	11.77 KB (12,048 bytes)	2/16/2001 5:17:51 AM	Microsoft Corporation	c:\winnt\system32\inetsrv\lonsint.dll
inetsloc.dll	5.00.0984	20.27 KB (20,752 bytes)	2/16/2001 5:17:52 AM	Microsoft Corporation	c:\winnt\system32\inetsloc.dll
iisfecnv.dll	5.00.0984	7.27 KB (7,440 bytes)	2/16/2001 5:17:51 AM	Microsoft Corporation	c:\winnt\system32\inetsrv\iisfecnv.dll
isatq.dll	5.00.0984	61.27 KB (62,736 bytes)	2/16/2001 5:17:53 AM	Microsoft Corporation	c:\winnt\system32\inetsrv\isatq.dll
infocomm.dll	5.00.0984	234.27 KB (239,888 bytes)	2/16/2001 5:17:51 AM	Microsoft Corporation	c:\winnt\system32\inetsrv\infocomm.dll
w3svc.dll	5.00.0984	347.27 KB (355,600 bytes)	2/16/2001 5:17:57 AM	Microsoft Corporation	c:\winnt\system32\inetsrv\w3svc.dll
security.dll	5.00.2154.1	5.77 KB (5,904 bytes)	12/7/1999 6:00:00 AM	Microsoft Corporation	c:\winnt\system32\security.dll
svcext.dll	5.00.0984	39.77 KB (40,720 bytes)	2/16/2001 5:17:51 AM	Microsoft Corporation	c:\winnt\system32\inetsrv\svcext.dll
admexs.dll	5.00.0984	27.77 KB (28,432 bytes)	2/16/2001 5:17:50 AM	Microsoft Corporation	c:\winnt\system32\inetsrv\admexs.dll
wamreg.dll	5.00.0984	46.27 KB (47,376 bytes)	2/16/2001 5:17:57 AM	Microsoft Corporation	c:\winnt\system32\inetsrv\wamreg.dll
metadata.dll	5.00.0984	70.77 KB (72,464 bytes)	2/16/2001 5:17:51 AM	Microsoft Corporation	c:\winnt\system32\inetsrv\metadata.dll
iismap.dll	5.00.0984	56.27 KB (57,616 bytes)	2/16/2001 5:17:52 AM	Microsoft Corporation	c:\winnt\system32\iismap.dll
nsepm.dll	5.00.0984	43.27 KB (44,304 bytes)	2/16/2001 5:17:51 AM	Microsoft Corporation	c:\winnt\system32\inetsrv\nsepm.dll
admwprox.dll	5.00.0984	31.77 KB (32,528 bytes)	2/16/2001 5:17:52 AM	Microsoft Corporation	c:\winnt\system32\admwprox.dll
coadmin.dll	5.00.0984	39.77 KB (40,720 bytes)	2/16/2001 5:17:52 AM	Microsoft Corporation	c:\winnt\system32\inetsrv\coadmin.dll
iisadmin.dll	5.00.0984	14.77 KB (15,120 bytes)	2/16/2001 5:17:50 AM	Microsoft Corporation	c:\winnt\system32\inetsrv\iisadmin.dll
rpcref.dll	5.00.0984	4.27 KB (4,368 bytes)	2/16/2001 5:17:51 AM	Microsoft Corporation	c:\winnt\system32\inetsrv\rpcref.dll
iisrtl.dll	5.00.0984	120.77 KB (123,664 bytes)	2/16/2001 5:17:52 AM	Microsoft Corporation	c:\winnt\system32\iisrtl.dll
inetinfo.exe	5.00.0984	14.27 KB (14,608 bytes)	2/16/2001 5:17:51 AM	Microsoft Corporation	c:\winnt\system32\inetsrv\inetinfo.exe
netui1.dll	5.00.2134.1	210.27 KB (215,312 bytes)	12/7/1999 6:00:00 AM	Microsoft Corporation	c:\winnt\system32\netui1.dll

Appendix C – Tunable Parameters

netui0.dll	5.00.2134.1	70.27 KB (71,952 bytes)	12/7/1999 6:00:00 AM	Microsoft Corporation	c:\winnt\system32\netui0.dll
ntlanman.dll	5.00.2157.1	35.27 KB (36,112 bytes)	12/7/1999 6:00:00 AM	Microsoft Corporation	c:\winnt\system32\ntlanman.dll
wshnetbs.dll	5.00.2134.1	7.77 KB (7,952 bytes)	12/7/1999 6:00:00 AM	Microsoft Corporation	c:\winnt\system32\wshnetbs.dll
rapilib.dll	5.00.2167.1	25.27 KB (25,872 bytes)	12/7/1999 6:00:00 AM	Microsoft Corporation	c:\winnt\system32\rapilib.dll
rsvpsp.dll	5.00.2167.1	74.77 KB (76,560 bytes)	12/7/1999 6:00:00 AM	Microsoft Corporation	c:\winnt\system32\rsvpsp.dll
ntmarta.dll	5.00.2158.1	98.77 KB (101,136 bytes)	12/7/1999 6:00:00 AM	Microsoft Corporation	c:\winnt\system32\ntmarta.dll
provthrd.dll	1.50.1085.0000	68.07 KB (69,708 bytes)	2/16/2001 11:22:56 AM	Microsoft Corporation	c:\winnt\system32\wbem\provthrd.dll
ntevt.dll	1.50.1085.0000	192.06 KB (196,669 bytes)	12/7/1999 6:00:00 AM	Microsoft Corporation	c:\winnt\system32\wbem\ntevt.dll
perfos.dll	5.00.2155.1	21.27 KB (21,776 bytes)	12/7/1999 6:00:00 AM	Microsoft Corporation	c:\winnt\system32\perfos.dll
psapi.dll	5.00.2134.1	28.27 KB (28,944 bytes)	12/7/1999 6:00:00 AM	Microsoft Corporation	c:\winnt\system32\psapi.dll
framedyn.dll	1.50.1085.0000	164.05 KB (167,992 bytes)	12/7/1999 6:00:00 AM	Microsoft Corporation	c:\winnt\system32\wbem\framedyn.dll
cimwin32.dll	1.50.1085.0000	1.03 MB (1,077,306 bytes)	12/7/1999 6:00:00 AM	Microsoft Corporation	c:\winnt\system32\wbem\cimwin32.dll
wbemsvc.dll	1.50.1085.0000	140.07 KB (143,430 bytes)	12/7/1999 6:00:00 AM	Microsoft Corporation	c:\winnt\system32\wbem\wbemsvc.dll
wbemess.dll	1.50.1085.0001	352.05 KB (360,503 bytes)	12/7/1999 6:00:00 AM	Microsoft Corporation	c:\winnt\system32\wbem\wbemess.dll
fastprox.dll	1.50.1085.0001	144.08 KB (147,534 bytes)	12/7/1999 6:00:00 AM	Microsoft Corporation	c:\winnt\system32\wbem\fastprox.dll
wbemcore.dll	1.50.1085.0001	1632.05 KB (647,224 bytes)	12/7/1999 6:00:00 AM	Microsoft Corporation	c:\winnt\system32\wbem\wbemcore.dll
wbemcomn.dll	1.50.1085.0001	1684.05 KB (700,472 bytes)	12/7/1999 6:00:00 AM	Microsoft Corporation	c:\winnt\system32\wbem\wbemcomn.dll
winmgmt.exe	1.50.1085.0001	188.05 KB (192,567 bytes)	12/7/1999 6:00:00 AM	Microsoft Corporation	c:\winnt\system32\wbem\winmgmt.exe
simptcp.dll	5.00.2134.1	19.27 KB (19,728 bytes)	2/16/2001 5:17:05 AM	Microsoft Corporation	c:\winnt\system32\simptcp.dll
tcpsvcs.exe	5.00.2134.1	24.77 KB (25,360 bytes)	12/7/1999 6:00:00 AM	Microsoft Corporation	c:\winnt\system32\tcpsvcs.exe
rasdlg.dll	5.00.2194.1	514.27 KB (526,608 bytes)	12/7/1999 6:00:00 AM	Microsoft Corporation	c:\winnt\system32\rasdlg.dll
netcfgx.dll	5.00.2175.1	533.77 KB (546,576 bytes)	12/7/1999 6:00:00 AM	Microsoft Corporation	c:\winnt\system32\netcfgx.dll
sens.dll	5.00.2163.1	36.77 KB (37,648 bytes)	12/7/1999 6:00:00 AM	Microsoft Corporation	c:\winnt\system32\sens.dll
rasmans.dll	5.00.2188.1	146.77 KB (150,288 bytes)	12/7/1999 6:00:00 AM	Microsoft Corporation	c:\winnt\system32\rasmans.dll
wmi.dll	5.00.2191.1	6.27 KB (6,416 bytes)	12/7/1999 6:00:00 AM	Microsoft Corporation	c:\winnt\system32\wmi.dll
netshell.dll	5.00.2176.1	456.77 KB (467,728 bytes)	12/7/1999 6:00:00 AM	Microsoft Corporation	c:\winnt\system32\netshell.dll
netman.dll	5.00.2175.1	88.77 KB (90,896 bytes)	12/7/1999 6:00:00 AM	Microsoft Corporation	c:\winnt\system32\netman.dll

Appendix C – Tunable Parameters

es.dll	1999.9.3422.21231.77 KB (237,328 bytes)	12/7/1999 6:00:00 AM	Microsoft Corporation	c:\winnt\system32\es.dll
iashlpr.dll	5.00.2184.1 33.27 KB (34,064 bytes)	12/7/1999 6:00:00 AM	Microsoft Corporation	c:\winnt\system32\iashlpr.dll
iasacct.dll	5.00.2134.1 28.27 KB (28,944 bytes)	12/7/1999 6:00:00 AM	Microsoft Corporation	c:\winnt\system32\iasacct.dll
iasuserr.dll	5.00.2134.1 25.77 KB (26,384 bytes)	12/7/1999 6:00:00 AM	Microsoft Corporation	c:\winnt\system32\iasuserr.dll
iasnap.dll	5.00.2134.1 58.77 KB (60,176 bytes)	12/7/1999 6:00:00 AM	Microsoft Corporation	c:\winnt\system32\iasnap.dll
iaspipe.dll	5.00.2134.1 41.77 KB (42,768 bytes)	12/7/1999 6:00:00 AM	Microsoft Corporation	c:\winnt\system32\iaspipe.dll
expsrv.dll	6.0.8540 370.27 KB (379,152 bytes)	12/7/1999 6:00:00 AM	Microsoft Corporation	c:\winnt\system32\expsrv.dll
vbajet32.dll	6.1.8268 30.27 KB (30,992 bytes)	12/7/1999 6:00:00 AM	Microsoft Corporation	c:\winnt\system32\vbajet32.dll
msjtes40.dll	4.00.2927.8 232.27 KB (237,840 bytes)	12/7/1999 6:00:00 AM	Microsoft Corporation	c:\winnt\system32\msjtes40.dll
oledb32r.dll	2.60.6526.0 68.27 KB (69,904 bytes)	2/16/2001 3:52:03 PM	Microsoft Corporation	c:\program files\common files\system\ole db\oledb32r.dll
comdlg32.dll	5.00.2920.0000236.77 KB (242,448 bytes)	12/7/1999 6:00:00 AM	Microsoft Corporation	c:\winnt\system32\comdlg32.dll
msdart.dll	2.60.6526.0 144.27 KB (147,728 bytes)	2/16/2001 3:52:02 PM	Microsoft Corporation	c:\winnt\system32\msdart.dll
oledb32.dll	2.60.6526.0 448.27 KB (459,024 bytes)	2/16/2001 3:52:03 PM	Microsoft Corporation	c:\program files\common files\system\ole db\oledb32.dll
msjint40.dll	4.00.2927.2 148.27 KB (151,824 bytes)	12/7/1999 6:00:00 AM	Microsoft Corporation	c:\winnt\system32\msjint40.dll
msjter40.dll	4.00.2927.2 52.27 KB (53,520 bytes)	12/7/1999 6:00:00 AM	Microsoft Corporation	c:\winnt\system32\msjter40.dll
mswstr10.dll	4.00.2927.10 600.27 KB (614,672 bytes)	12/7/1999 6:00:00 AM	Microsoft Corporation	c:\winnt\system32\mswstr10.dll
msjet40.dll	4.00.2927.4 1.43 MB (1,495,312 bytes)	12/7/1999 6:00:00 AM	Microsoft Corporation	c:\winnt\system32\msjet40.dll
msjetoledb40.dll	4.00.2927.2 340.27 KB (348,432 bytes)	12/7/1999 6:00:00 AM	Microsoft Corporation	c:\winnt\system32\msjetoledb40.dll
iasrad.dll	5.00.2139.1 94.27 KB (96,528 bytes)	12/7/1999 6:00:00 AM	Microsoft Corporation	c:\winnt\system32\iasrad.dll
iassam.dll	5.00.2160.1 96.27 KB (98,576 bytes)	12/7/1999 6:00:00 AM	Microsoft Corporation	c:\winnt\system32\iassam.dll
iasads.dll	5.00.2134.1 73.77 KB (75,536 bytes)	12/7/1999 6:00:00 AM	Microsoft Corporation	c:\winnt\system32\iasads.dll
iaspolcy.dll	5.00.2134.1 25.27 KB (25,872 bytes)	12/7/1999 6:00:00 AM	Microsoft Corporation	c:\winnt\system32\iaspolcy.dll
iassvcs.dll	5.00.2160.1 58.77 KB (60,176 bytes)	12/7/1999 6:00:00 AM	Microsoft Corporation	c:\winnt\system32\iassvcs.dll
iassdo.dll	5.00.2157.1 262.27 KB (268,560 bytes)	12/7/1999 6:00:00 AM	Microsoft Corporation	c:\winnt\system32\iassdo.dll
ias.dll	5.00.2134.1 7.27 KB (7,440 bytes)	12/7/1999 6:00:00 AM	Microsoft Corporation	c:\winnt\system32\ias.dll
mtxoci.dll	1999.9.3421.3 109.27 KB (111,888 bytes)	2/16/2001 5:17:13 AM	Microsoft Corporation	c:\winnt\system32\mtxoci.dll
resutils.dll	5.00.2191.1 39.77 KB (40,720 bytes)	12/7/1999 6:00:00 AM	Microsoft Corporation	c:\winnt\system32\resutils.dll

Appendix C – Tunable Parameters

clusapi.dll	5.00.2179.1	50.27 KB (51,472 bytes)	12/7/1999 6:00:00 AM	Microsoft Corporation	c:\winnt\system32\clusapi.dll
msvcp50.dll	5.00.7051	552.50 KB (565,760 bytes)	12/7/1999 6:00:00 AM	Microsoft Corporation	c:\winnt\system32\msvcp50.dll
xolehlp.dll	1999.9.3421.3	17.27 KB (17,680 bytes)	2/16/2001 5:17:12 AM	Microsoft Corporation	c:\winnt\system32\xolehlp.dll
msdtclog.dll	1999.9.3421.3	89.77 KB (91,920 bytes)	2/16/2001 5:17:10 AM	Microsoft Corporation	c:\winnt\system32\msdtclog.dll
mtxclu.dll	1999.9.3421.3	50.27 KB (51,472 bytes)	12/7/1999 6:00:00 AM	Microsoft Corporation	c:\winnt\system32\mtxclu.dll
msdtcprx.dll	1999.9.3422.10619.27	KB (634,128 bytes)	2/16/2001 5:17:12 AM	Microsoft Corporation	c:\winnt\system32\msdtcprx.dll
txfaux.dll	1999.9.3422.24341.27	KB (349,456 bytes)	2/16/2001 5:17:11 AM	Microsoft Corporation	c:\winnt\system32\txfaux.dll
msdtctm.dll	1999.9.3422.121.02	MB (1,070,864 bytes)	2/16/2001 5:17:12 AM	Microsoft Corporation	c:\winnt\system32\msdtctm.dll
msdtc.exe	1999.9.3421.3	6.77 KB (6,928 bytes)	2/16/2001 5:17:10 AM	Microsoft Corporation	c:\winnt\system32\msdtc.exe
rasadhlp.dll	5.00.2168.1	7.27 KB (7,440 bytes)	12/7/1999 6:00:00 AM	Microsoft Corporation	c:\winnt\system32\rasadhlp.dll
winnr.dll	5.00.2160.1	18.77 KB (19,216 bytes)	12/7/1999 6:00:00 AM	Microsoft Corporation	c:\winnt\system32\winnr.dll
dhcpcsvc.dll	5.00.2153.1	88.77 KB (90,896 bytes)	12/7/1999 6:00:00 AM	Microsoft Corporation	c:\winnt\system32\dhcpcsvc.dll
tapi32.dll	5.00.2182.1	123.27 KB (126,224 bytes)	12/7/1999 6:00:00 AM	Microsoft Corporation	c:\winnt\system32\tapi32.dll
rasman.dll	5.00.2188.1	54.77 KB (56,080 bytes)	12/7/1999 6:00:00 AM	Microsoft Corporation	c:\winnt\system32\rasman.dll
rasapi32.dll	5.00.2188.1	189.77 KB (194,320 bytes)	12/7/1999 6:00:00 AM	Microsoft Corporation	c:\winnt\system32\rasapi32.dll
icmp.dll	5.00.2134.1	7.27 KB (7,440 bytes)	12/7/1999 6:00:00 AM	Microsoft Corporation	c:\winnt\system32\icmp.dll
iphlpapi.dll	5.00.2173.2	67.77 KB (69,392 bytes)	12/7/1999 6:00:00 AM	Microsoft Corporation	c:\winnt\system32\iphlpapi.dll
rnr20.dll	5.00.2152.1	35.77 KB (36,624 bytes)	12/7/1999 6:00:00 AM	Microsoft Corporation	c:\winnt\system32\rnr20.dll
wshtcpip.dll	5.00.2134.1	17.27 KB (17,680 bytes)	12/7/1999 6:00:00 AM	Microsoft Corporation	c:\winnt\system32\wshtcpip.dll
msafd.dll	5.00.2153.1	54.27 KB (55,568 bytes)	12/7/1999 6:00:00 AM	Microsoft Corporation	c:\winnt\system32\msafd.dll
rpcss.dll	5.00.2181.1	229.27 KB (234,768 bytes)	12/7/1999 6:00:00 AM	Microsoft Corporation	c:\winnt\system32\rpcss.dll
svchost.exe	5.00.2134.1	7.77 KB (7,952 bytes)	12/7/1999 6:00:00 AM	Microsoft Corporation	c:\winnt\system32\svchost.exe
vipl.dll	4.1.1	80.00 KB (81,920 bytes)	2/16/2001 3:26:22 PM	Giganet Incorporated	c:\winnt\system32\vipl.dll
gnconmgr.exe	4.2.0.23	140.06 KB (143,420 bytes)	2/20/2001 11:50:27 AM	Giganet Incorporated	c:\winnt\system32\gnconmgr.exe
iissuba.dll	5.00.0984	9.77 KB (10,000 bytes)	12/7/1999 6:00:00 AM	Microsoft Corporation	c:\winnt\system32\iissuba.dll
scecli.dll	5.00.2191.1	105.27 KB (107,792 bytes)	12/7/1999 6:00:00 AM	Microsoft Corporation	c:\winnt\system32\scecli.dll
atl.dll	3.00.8449	57.56 KB (58,938 bytes)	12/7/1999 6:00:00 AM	Microsoft Corporation	c:\winnt\system32\atl.dll

Appendix C – Tunable Parameters

certcli.dll	5.00.2175.1	132.27 KB (135,440 bytes)	12/7/1999 6:00:00 AM
Microsoft Corporation	c:\winnt\system32\certcli.dll		
esent.dll	6.0.3939.6	1.07 MB (1,120,016 bytes)	12/7/1999 6:00:00 AM
Microsoft Corporation	c:\winnt\system32\esent.dll		
mswsock.dll	5.00.2152.1	62.27 KB (63,760 bytes)	12/7/1999 6:00:00 AM Microsoft Corporation
Microsoft Corporation	c:\winnt\system32\mswsock.dll		
ntdsatq.dll	5.00.2181.1	31.27 KB (32,016 bytes)	12/7/1999 6:00:00 AM Microsoft Corporation
Microsoft Corporation	c:\winnt\system32\ntdsatq.dll		
ntdsa.dll	5.00.2195.1	993.27 KB (1,017,104 bytes)	12/7/1999 6:00:00 AM
Microsoft Corporation	c:\winnt\system32\ntdsa.dll		
kdcsvc.dll	5.00.2181.1	133.77 KB (136,976 bytes)	12/7/1999 6:00:00 AM
Microsoft Corporation	c:\winnt\system32\kdcsvc.dll		
sfmapi.dll	5.00.2134.1	38.77 KB (39,696 bytes)	12/7/1999 6:00:00 AM Microsoft Corporation
Microsoft Corporation	c:\winnt\system32\sfmapi.dll		
rtutils.dll	5.00.2168.1	43.77 KB (44,816 bytes)	12/7/1999 6:00:00 AM Microsoft Corporation
Microsoft Corporation	c:\winnt\system32\rtutils.dll		
adslrpc.dll	5.00.2172.1	127.77 KB (130,832 bytes)	12/7/1999 6:00:00 AM
Microsoft Corporation	c:\winnt\system32\adslrpc.dll		
activeds.dll	5.00.2172.1	172.77 KB (176,912 bytes)	12/7/1999 6:00:00 AM
Microsoft Corporation	c:\winnt\system32\activeds.dll		
mprapi.dll	5.00.2181.1	79.27 KB (81,168 bytes)	12/7/1999 6:00:00 AM Microsoft Corporation
Microsoft Corporation	c:\winnt\system32\mprapi.dll		
rassfm.dll	5.00.2168.1	21.27 KB (21,776 bytes)	12/7/1999 6:00:00 AM Microsoft Corporation
Microsoft Corporation	c:\winnt\system32\rassfm.dll		
mpr.dll	5.00.2146.1	53.27 KB (54,544 bytes)	12/7/1999 6:00:00 AM Microsoft Corporation
Microsoft Corporation	c:\winnt\system32\mpr.dll		
schannel.dll	5.00.2170.1	139.77 KB (143,120 bytes)	12/7/1999 6:00:00 AM
Microsoft Corporation	c:\winnt\system32\schannel.dll		
netlogon.dll	5.00.2182.1	347.77 KB (356,112 bytes)	12/7/1999 6:00:00 AM
Microsoft Corporation	c:\winnt\system32\netlogon.dll		
msv1_0.dll	5.00.2164.1	94.77 KB (97,040 bytes)	12/7/1999 6:00:00 AM Microsoft Corporation
Microsoft Corporation	c:\winnt\system32\msv1_0.dll		
kerberos.dll	5.00.2181.1	196.77 KB (201,488 bytes)	12/7/1999 6:00:00 AM
Microsoft Corporation	c:\winnt\system32\kerberos.dll		
msprivs.dll	5.00.2154.1	41.50 KB (42,496 bytes)	12/7/1999 6:00:00 AM Microsoft Corporation
Microsoft Corporation	c:\winnt\system32\msprivs.dll		
samsrv.dll	5.00.2192.1	357.77 KB (366,352 bytes)	12/7/1999 6:00:00 AM
Microsoft Corporation	c:\winnt\system32\samsrv.dll		
lsasrv.dll	5.00.2184.1	487.77 KB (499,472 bytes)	12/7/1999 6:00:00 AM
Microsoft Corporation	c:\winnt\system32\lsasrv.dll		
lsass.exe	5.00.2184.1	32.77 KB (33,552 bytes)	12/7/1999 6:00:00 AM Microsoft Corporation
Microsoft Corporation	c:\winnt\system32\lsass.exe		
wmicore.dll	5.00.2178.1	70.77 KB (72,464 bytes)	12/7/1999 6:00:00 AM Microsoft Corporation
Microsoft Corporation	c:\winnt\system32\wmicore.dll		
psbase.dll	5.00.2146.1	111.77 KB (114,448 bytes)	12/7/1999 6:00:00 AM
Microsoft Corporation	c:\winnt\system32\psbase.dll		
cryptsvc.dll	5.00.2181.1	61.77 KB (63,248 bytes)	12/7/1999 6:00:00 AM Microsoft Corporation
Microsoft Corporation	c:\winnt\system32\cryptsvc.dll		
cryptdll.dll	5.00.2135.1	41.27 KB (42,256 bytes)	12/7/1999 6:00:00 AM Microsoft Corporation
Microsoft Corporation	c:\winnt\system32\cryptdll.dll		
wkssvc.dll	5.00.2181.1	95.27 KB (97,552 bytes)	12/7/1999 6:00:00 AM Microsoft Corporation
Microsoft Corporation	c:\winnt\system32\wkssvc.dll		
srvsvc.dll	5.00.2178.1	79.27 KB (81,168 bytes)	12/7/1999 6:00:00 AM Microsoft Corporation
Microsoft Corporation	c:\winnt\system32\srvsvc.dll		

Appendix C – Tunable Parameters

cfgmgr32.dll	5.00.2134.1	16.77 KB (17,168 bytes)	12/7/1999 6:00:00 AM	Microsoft Corporation	c:\winnt\system32\cfgmgr32.dll
dmserver.dll	2191.1.296.2	11.77 KB (12,048 bytes)	12/7/1999 6:00:00 AM	VERITAS Software Corp.	c:\winnt\system32\dmserver.dll
winsta.dll	5.00.2134.1	36.27 KB (37,136 bytes)	12/7/1999 6:00:00 AM	Microsoft Corporation	c:\winnt\system32\winsta.dll
eventlog.dll	5.00.2178.1	43.77 KB (44,816 bytes)	12/7/1999 6:00:00 AM	Microsoft Corporation	c:\winnt\system32\eventlog.dll
ntdsapi.dll	5.00.2160.1	56.27 KB (57,616 bytes)	12/7/1999 6:00:00 AM	Microsoft Corporation	c:\winnt\system32\ntdsapi.dll
scesrv.dll	5.00.2188.1	225.77 KB (231,184 bytes)	12/7/1999 6:00:00 AM	Microsoft Corporation	c:\winnt\system32\scesrv.dll
umpnpmgr.dll	5.00.2182.1	86.27 KB (88,336 bytes)	12/7/1999 6:00:00 AM	Microsoft Corporation	c:\winnt\system32\umpnpmgr.dll
services.exe	5.00.2134.1	86.77 KB (88,848 bytes)	12/7/1999 6:00:00 AM	Microsoft Corporation	c:\winnt\system32\services.exe
clbcatq.dll	1999.9.3422.14479.27	KB (490,768 bytes)	2/16/2001 5:17:05 AM	Microsoft Corporation	c:\winnt\system32\clbcatq.dll
oleaut32.dll	2.40.4512	600.27 KB (614,672 bytes)	12/7/1999 6:00:00 AM	Microsoft Corporation	c:\winnt\system32\oleaut32.dll
cscui.dll	5.00.2172.1	227.27 KB (232,720 bytes)	12/7/1999 6:00:00 AM	Microsoft Corporation	c:\winnt\system32\cscui.dll
winspool.drv	5.00.2167.1	109.77 KB (112,400 bytes)	12/7/1999 6:00:00 AM	Microsoft Corporation	c:\winnt\system32\winspool.drv
winscard.dll	5.00.2134.1	77.27 KB (79,120 bytes)	12/7/1999 6:00:00 AM	Microsoft Corporation	c:\winnt\system32\winscard.dll
wlnotify.dll	5.00.2164.1	53.27 KB (54,544 bytes)	12/7/1999 6:00:00 AM	Microsoft Corporation	c:\winnt\system32\wlnotify.dll
cscdll.dll	5.00.2189.1	98.27 KB (100,624 bytes)	12/7/1999 6:00:00 AM	Microsoft Corporation	c:\winnt\system32\cscdll.dll
lz32.dll	5.00.2134.1	9.77 KB (10,000 bytes)	12/7/1999 6:00:00 AM	Microsoft Corporation	c:\winnt\system32\lz32.dll
version.dll	5.00.2134.1	15.77 KB (16,144 bytes)	12/7/1999 6:00:00 AM	Microsoft Corporation	c:\winnt\system32\version.dll
rsabase.dll	5.00.2150.1	128.77 KB (131,856 bytes)	12/7/1999 6:00:00 AM	Microsoft Corporation	c:\winnt\system32\rsabase.dll
mecat32.dll	5.131.2134.1	7.77 KB (7,952 bytes)	12/7/1999 6:00:00 AM	Microsoft Corporation	c:\winnt\system32\mecat32.dll
ole32.dll	5.00.2181.1	966.27 KB (989,456 bytes)	12/7/1999 6:00:00 AM	Microsoft Corporation	c:\winnt\system32\ole32.dll
imagehlp.dll	5.00.2195.1	125.27 KB (128,272 bytes)	12/7/1999 6:00:00 AM	Microsoft Corporation	c:\winnt\system32\imagehlp.dll
msasn1.dll	5.00.2134.1	51.27 KB (52,496 bytes)	12/7/1999 6:00:00 AM	Microsoft Corporation	c:\winnt\system32\msasn1.dll
crypt32.dll	5.131.2173.1	465.77 KB (476,944 bytes)	12/7/1999 6:00:00 AM	Microsoft Corporation	c:\winnt\system32\crypt32.dll
wintrust.dll	5.131.2143.1	162.27 KB (166,160 bytes)	12/7/1999 6:00:00 AM	Microsoft Corporation	c:\winnt\system32\wintrust.dll
setupapi.dll	5.00.2183.1	554.27 KB (567,568 bytes)	12/7/1999 6:00:00 AM	Microsoft Corporation	c:\winnt\system32\setupapi.dll
winmm.dll	5.00.2161.1	184.77 KB (189,200 bytes)	12/7/1999 6:00:00 AM	Microsoft Corporation	c:\winnt\system32\winmm.dll
comctl32.dll	5.81	540.27 KB (553,232 bytes)	12/7/1999 6:00:00 AM	Microsoft Corporation	c:\winnt\system32\comctl32.dll

Appendix C – Tunable Parameters

shlwapi.dll	5.00.2920.0000	282.77 KB (289,552 bytes)	12/7/1999 6:00:00 AM	
	Microsoft Corporation	c:\winnt\system32\shlwapi.dll		
shell32.dll	5.00.2920.0000	2.24 MB (2,352,400 bytes)	12/7/1999 6:00:00 AM	
	Microsoft Corporation	c:\winnt\system32\shell32.dll		
msgina.dll	5.00.2191.1	309.77 KB (317,200 bytes)	12/7/1999 6:00:00 AM	
	Microsoft Corporation	c:\winnt\system32\msgina.dll		
wsock32.dll	5.00.2152.1	21.27 KB (21,776 bytes)	12/7/1999 6:00:00 AM	Microsoft Corporation
		c:\winnt\system32\wsock32.dll		
dnsapi.dll	5.00.2181.1	129.77 KB (132,880 bytes)	12/7/1999 6:00:00 AM	
	Microsoft Corporation	c:\winnt\system32\dnsapi.dll		
wldap32.dll	5.00.2168.1	155.77 KB (159,504 bytes)	12/7/1999 6:00:00 AM	
	Microsoft Corporation	c:\winnt\system32\wldap32.dll		
ws2help.dll	5.00.2134.1	17.77 KB (18,192 bytes)	12/7/1999 6:00:00 AM	Microsoft Corporation
		c:\winnt\system32\ws2help.dll		
ws2_32.dll	5.00.2134.1	69.77 KB (71,440 bytes)	12/7/1999 6:00:00 AM	Microsoft Corporation
		c:\winnt\system32\ws2_32.dll		
samlib.dll	5.00.2160.1	46.27 KB (47,376 bytes)	12/7/1999 6:00:00 AM	Microsoft Corporation
		c:\winnt\system32\samlib.dll		
netrap.dll	5.00.2134.1	11.27 KB (11,536 bytes)	12/7/1999 6:00:00 AM	Microsoft Corporation
		c:\winnt\system32\netrap.dll		
netapi32.dll	5.00.2194.1	302.77 KB (310,032 bytes)	12/7/1999 6:00:00 AM	
	Microsoft Corporation	c:\winnt\system32\netapi32.dll		
profmap.dll	5.00.2181.1	29.27 KB (29,968 bytes)	12/7/1999 6:00:00 AM	Microsoft Corporation
		c:\winnt\system32\profmap.dll		
secur32.dll	5.00.2154.1	46.77 KB (47,888 bytes)	12/7/1999 6:00:00 AM	Microsoft Corporation
		c:\winnt\system32\secur32.dll		
sfc.dll	5.00.2164.1	84.27 KB (86,288 bytes)	12/7/1999 6:00:00 AM	Microsoft Corporation
		c:\winnt\system32\sfc.dll		
nddeapi.dll	5.00.2137.1	15.27 KB (15,632 bytes)	12/7/1999 6:00:00 AM	Microsoft Corporation
		c:\winnt\system32\nddeapi.dll		
userenv.dll	5.00.2185.1	361.27 KB (369,936 bytes)	12/7/1999 6:00:00 AM	
	Microsoft Corporation	c:\winnt\system32\userenv.dll		
user32.dll	5.00.2180.1	393.27 KB (402,704 bytes)	12/7/1999 6:00:00 AM	
	Microsoft Corporation	c:\winnt\system32\user32.dll		
gdi32.dll	5.00.2180.1	228.77 KB (234,256 bytes)	12/7/1999 6:00:00 AM	
	Microsoft Corporation	c:\winnt\system32\gdi32.dll		
rpcrt4.dll	5.00.2193.1	434.27 KB (444,688 bytes)	12/7/1999 6:00:00 AM	
	Microsoft Corporation	c:\winnt\system32\rpcrt4.dll		
advapi32.dll	5.00.2191.1	349.27 KB (357,648 bytes)	12/7/1999 6:00:00 AM	
	Microsoft Corporation	c:\winnt\system32\advapi32.dll		
kernel32.dll	5.00.2191.1	715.27 KB (732,432 bytes)	12/7/1999 6:00:00 AM	
	Microsoft Corporation	c:\winnt\system32\kernel32.dll		
msvcrt.dll	6.10.8637.0	288.09 KB (295,000 bytes)	12/7/1999 6:00:00 AM	
	Microsoft Corporation	c:\winnt\system32\msvcrt.dll		
winlogon.exe	5.00.2182.1	173.27 KB (177,424 bytes)	12/7/1999 6:00:00 AM	
	Microsoft Corporation	c:\winnt\system32\winlogon.exe		
sfcfiles.dll	5.00.2195.1	973.27 KB (996,624 bytes)	12/7/1999 6:00:00 AM	
	Microsoft Corporation	c:\winnt\system32\sfcfiles.dll		
ntdll.dll	5.00.2163.1	469.77 KB (481,040 bytes)	12/7/1999 6:00:00 AM	Microsoft Corporation
		c:\winnt\system32\ntdll.dll		
smss.exe	5.00.2170.1	44.27 KB (45,328 bytes)	12/7/1999 6:00:00 AM	Microsoft Corporation
		c:\winnt\system32\smss.exe		

[Services]

Appendix C – Tunable Parameters

Display Name	Name	State	Start Mode	Service Type	Path	Error Control	Start
Name	Tag ID						
Alerter	Alerter	Stopped	Manual	Share Process	c:\winnt\system32\services.exe	Normal	LocalSystem 0
Application Management			AppMgmt	Stopped	Manual	Share Process	
					c:\winnt\system32\services.exe	Normal	LocalSystem 0
Computer Browser	Browser	Stopped		Manual	Share Process		
					c:\winnt\system32\services.exe	Normal	LocalSystem 0
Indexing Service	cisvc	Stopped		Manual	Share Process		
					c:\winnt\system32\cisvc.exe	Normal	LocalSystem 0
ClipBook	ClipSrv	Stopped		Manual	Own Process		c:\winnt\system32\clipsrv.exe
						Normal	LocalSystem 0
Distributed File System Dfs		Running		Auto	Own Process		
					c:\winnt\system32\dfssvc.exe	Normal	LocalSystem 0
DHCP Client	Dhcp	Stopped		Manual	Share Process		c:\winnt\system32\services.exe
						Normal	LocalSystem 0
Logical Disk Manager Administrative Service	dmadmin	Stopped		Manual	Share Process		
					c:\winnt\system32\dmadmin.exe	Normal	LocalSystem 0
Logical Disk Manager	dmserver	Running		Auto	Share Process		
					c:\winnt\system32\services.exe	Normal	LocalSystem 0
DNS Client	Dnscache	Stopped		Manual	Share Process		
					c:\winnt\system32\services.exe	Normal	LocalSystem 0
Event Log	Eventlog	Running		Auto	Share Process		
					c:\winnt\system32\services.exe	Normal	LocalSystem 0
COM+ Event System	EventSystem	Running		Manual	Share Process		
					c:\winnt\system32\svchost.exe	Normal	LocalSystem 0
Fax Service	Fax	Stopped		Manual	Own Process		c:\winnt\system32\faxsvc.exe
						Normal	LocalSystem 0
cLAN Connection Manager	GniConMgr	Running		Auto	Own Process		
					c:\winnt\system32\gnconmgr.exe	Normal	LocalSystem 0
Internet Authentication Service	IAS	Running		Auto	Share Process		
					c:\winnt\system32\svchost.exe	Normal	LocalSystem 0
IIS Admin Service	IISADMIN	Running		Auto	Share Process		
					c:\winnt\system32\inetsrv\inetinfo.exe	Normal	LocalSystem 0
Intersite Messaging	Ismserv	Stopped		Disabled	Own Process		
					c:\winnt\system32\ismserv.exe	Normal	LocalSystem 0
Kerberos Key Distribution Center	kdc	Stopped		Disabled	Share Process		
					c:\winnt\system32\lsass.exe	Normal	LocalSystem 0
Server	lanmanserver	Running		Auto	Share Process		c:\winnt\system32\services.exe
						Normal	LocalSystem 0
Workstation	lanmanworkstation	Running		Auto	Share Process		
					c:\winnt\system32\services.exe	Normal	LocalSystem 0
License Logging Service	LicenseService	Stopped		Manual	Own Process		
					c:\winnt\system32\llssrv.exe	Normal	LocalSystem 0
TCP/IP NetBIOS Helper Service	LmHosts	Stopped		Manual	Share Process		
					c:\winnt\system32\services.exe	Normal	LocalSystem 0
Messenger	Messenger	Stopped		Manual	Share Process		
					c:\winnt\system32\services.exe	Normal	LocalSystem 0
NetMeeting Remote Desktop Sharing	mnmsrv	Stopped		Manual	Own Process		
					c:\winnt\system32\mnmsrv.exe	Normal	LocalSystem 0
Distributed Transaction Coordinator	MSDTC	Running		Auto	Own Process		
					c:\winnt\system32\msdtc.exe	Normal	LocalSystem 0
Windows Installer	MSIServer	Stopped		Manual	Share Process		
					c:\winnt\system32\msiexec.exe	Normal	LocalSystem 0

Appendix C – Tunable Parameters

Network DDE	NetDDE	Stopped	Manual Share Process	
	c:\winnt\system32\netdde.exe	Normal	LocalSystem	0
Network DDE DSDM	NetDDEdsdm	Stopped	Manual Share Process	
	c:\winnt\system32\netdde.exe	Normal	LocalSystem	0
Net Logon	Netlogon	Stopped	Manual Share Process	
	c:\winnt\system32\lsass.exe	Normal	LocalSystem	0
Network Connections	Netman	Running	Manual Share Process	
	c:\winnt\system32\svchost.exe -k netsvcs	Normal	LocalSystem	0
File Replication	NtFrs	Stopped	Manual Own Process	c:\winnt\system32\ntfrs.exe
	Ignore	LocalSystem	0	
NT LM Security Support Provider		NtLmSsp	Stopped	Manual Share Process
	c:\winnt\system32\lsass.exe	Normal	LocalSystem	0
Removable Storage	NtmsSvc	Stopped	Manual Share Process	
	c:\winnt\system32\svchost.exe -k netsvcs	Normal	LocalSystem	0
Plug and Play	PlugPlay	Running	Auto	Share Process
	c:\winnt\system32\services.exe	Normal	LocalSystem	0
IPSEC Policy Agent	PolicyAgent	Stopped	Manual Share Process	
	c:\winnt\system32\lsass.exe	Normal	LocalSystem	0
Protected Storage	ProtectedStorage	Running	Auto	Share Process
	c:\winnt\system32\services.exe	Normal	LocalSystem	0
Remote Access Auto Connection Manager		RasAuto	Stopped	Manual Share Process
	c:\winnt\system32\svchost.exe -k netsvcs	Normal	LocalSystem	0
Remote Access Connection Manager		RasMan	Stopped	Manual Share Process
	c:\winnt\system32\svchost.exe -k netsvcs	Normal	LocalSystem	0
Routing and Remote Access	RemoteAccess	Stopped	Disabled	Share Process
	c:\winnt\system32\svchost.exe -k netsvcs	Normal	LocalSystem	0
Remote Registry Service	RemoteRegistry	Stopped	Manual Own Process	
	c:\winnt\system32\regsvc.exe	Normal	LocalSystem	0
Remote Command Service	RMSYS	Stopped	Manual Own Process	
	c:\benchcrf\rsys.exe	Normal	LocalSystem	0
Remote Procedure Call (RPC) Locator	RpcLocator	Stopped	Manual Own Process	
	c:\winnt\system32\locator.exe	Normal	LocalSystem	0
Remote Procedure Call (RPC)	RpcSs	Running	Auto	Share Process
	c:\winnt\system32\svchost -k rpcss	Normal	LocalSystem	0
QoS RSVP	RSVP	Running	Manual Own Process	c:\winnt\system32\rsvp.exe -s
	Normal	LocalSystem	0	
Security Accounts Manager	SamSs	Running	Auto	Share Process
	c:\winnt\system32\lsass.exe	Normal	LocalSystem	0
Smart Card Helper	SCardDrv	Stopped	Manual Share Process	
	c:\winnt\system32\scardsvr.exe	Ignore	LocalSystem	0
Smart Card	SCardSvr	Stopped	Manual Share Process	
	c:\winnt\system32\scardsvr.exe	Ignore	LocalSystem	0
Task Scheduler	Schedule	Stopped	Manual Share Process	
	c:\winnt\system32\mstask.exe	Normal	LocalSystem	0
RunAs Service	seclogon	Stopped	Manual Share Process	
	c:\winnt\system32\services.exe	Ignore	LocalSystem	0
System Event Notification	SENS	Stopped	Manual Share Process	
	c:\winnt\system32\svchost.exe -k netsvcs	Normal	LocalSystem	0
Internet Connection Sharing	SharedAccess	Stopped	Manual Share Process	
	c:\winnt\system32\svchost.exe -k netsvcs	Normal	LocalSystem	0
Simple TCP/IP Services	SimpTcp	Running	Auto	Share Process
	c:\winnt\system32\tcpsvcs.exe	Normal	LocalSystem	0
Print Spooler	Spooler	Stopped	Manual Own Process	c:\winnt\system32\spoolsv.exe
	Normal	LocalSystem	0	

Appendix C – Tunable Parameters

Performance Logs and Alerts	SysmonLog	Stopped	Manual Own Process
c:\winnt\system32\smlogsvc.exe		Normal LocalSystem	0
Telephony	TapiSrv	Running	Manual Share Process
k tapisrv		Normal LocalSystem	0
Terminal Services	TermService	Stopped	Disabled Own Process
c:\winnt\system32\termsrv.exe		Normal LocalSystem	0
Telnet	TlntSvr	Stopped	Manual Own Process
c:\winnt\system32\tlntsvr.exe		Normal LocalSystem	0
Distributed Link Tracking Server	TrkSvr	Stopped	Manual Share Process
c:\winnt\system32\services.exe		Normal LocalSystem	0
Distributed Link Tracking Client	TrkWks	Stopped	Manual Share Process
c:\winnt\system32\services.exe		Normal LocalSystem	0
Uninterruptible Power Supply	UPS	Stopped	Manual Own Process
c:\winnt\system32\ups.exe		Normal LocalSystem	0
Utility Manager	UtilMan	Stopped	Manual Own Process
c:\winnt\system32\utilman.exe		Normal LocalSystem	0
Windows Time	W32Time	Stopped	Manual Share Process
c:\winnt\system32\services.exe		Normal LocalSystem	0
World Wide Web Publishing Service	W3SVC	Running	Auto Share Process
c:\winnt\system32\inetsrv\inetinfo.exe		Normal LocalSystem	0
Windows Management Instrumentation	WinMgmt	Running	Auto Own Process
c:\winnt\system32\wbem\winmgmt.exe		Ignore LocalSystem	0
Windows Management Instrumentation Driver Extensions	Wmi	Running	Manual
c:\winnt\system32\services.exe		Normal LocalSystem	0

[Program Groups]

Group Name	Name	User Name
Accessories	Default User:Accessories	Default User
Accessories\Accessibility	Default User:Accessories\Accessibility	Default User
Accessories\Entertainment	Default User:Accessories\Entertainment	Default User
Accessories\System Tools	Default User:Accessories\System Tools	Default User
Administrative Tools	Default User:Administrative Tools	Default User
Startup	Default User:Startup	Default User
Accessories	All Users:Accessories	All Users
Accessories\Accessibility	All Users:Accessories\Accessibility	All Users
Accessories\Communications	All Users:Accessories\Communications	All Users
Accessories\Entertainment	All Users:Accessories\Entertainment	All Users
Accessories\Games	All Users:Accessories\Games	All Users
Accessories\System Tools	All Users:Accessories\System Tools	All Users
Administrative Tools	All Users:Administrative Tools	All Users
Microsoft Office Tools	All Users:Microsoft Office Tools	All Users
Microsoft SQL Server	All Users:Microsoft SQL Server	All Users
MKS Toolkit	All Users:MKS Toolkit	All Users
Startup	All Users:Startup	All Users
WinZip	All Users:WinZip	All Users
Accessories	CLIENT3\Administrator:Accessories	CLIENT3\Administrator
Accessories\Accessibility	CLIENT3\Administrator:Accessories\Accessibility	CLIENT3\Administrator
Accessories\Entertainment	CLIENT3\Administrator:Accessories\Entertainment	CLIENT3\Administrator
Accessories\System Tools	CLIENT3\Administrator:Accessories\System Tools	CLIENT3\Administrator
Administrative Tools	CLIENT3\Administrator:Administrative Tools	CLIENT3\Administrator
Startup	CLIENT3\Administrator:Startup	CLIENT3\Administrator

Appendix C – Tunable Parameters

[Startup Programs]

Program	Command	User Name	Location	All Users	Common
Microsoft Office Startup	c:\progra~1\micros~3\office\osa9.exe -b -l			All Users	Common

[OLE Registration]

Object	Local Server	Command	User Name	Location	All Users	Common
Microsoft Graph 2000 Chart		C:\PROGRA~1\MICROS~3\Office\GRAPH9.EXE				
Microsoft Excel Worksheet		Not Available				
Microsoft Excel Chart		Not Available				
Microsoft Excel Worksheet		C:\PROGRA~1\MICROS~3\Office\EXCEL.EXE				
Microsoft Excel Chart		C:\PROGRA~1\MICROS~3\Office\EXCEL.EXE				
Microsoft Word 6.0 - 7.0 Document		Not Available				
Microsoft Word 6.0 - 7.0 Picture		Not Available				
Microsoft Word Document		C:\PROGRA~1\MICROS~3\Office\WINWORD.EXE				
Microsoft Word Picture		C:\PROGRA~1\MICROS~3\Office\WINWORD.EXE				
Sound (OLE2)		sndrec32.exe				
Microsoft Clip Gallery		C:\PROGRA~1\COMMON~1\MICROS~1\Artgalry\artgalY.exe				
Media Clip		mplay32.exe				
Video Clip		mplay32.exe /avi				
MIDI Sequence		mplay32.exe /mid				
		Not Available				
Microsoft Excel Chart		Not Available				
Microsoft Excel 4.0 Macro		Not Available				
Sound		Not Available				
Media Clip		Not Available				
		Not Available				
		Not Available				
Image Document		"C:\Program Files\Windows NT\Accessories\ImageVue\KodakImg.exe"				
Microsoft PowerPoint Presentation		C:\PROGRA~1\MICROS~3\Office\POWERPNT.EXE				
Microsoft PowerPoint Slide		C:\PROGRA~1\MICROS~3\Office\POWERPNT.EXE				
WordPad Document		"%ProgramFiles%\Windows NT\Accessories\WORDPAD.EXE"				
Windows Media Services DRM Storage object		Not Available				
Bitmap Image		mspaint.exe				
		Not Available				
		Not Available				

[Internet Explorer 5]

[Following are sub-categories of this main category]

[Summary]

Item	Value
Version	5.00.2920.0000
Build	52920
Product ID	51876-OEM-0000007-00000
Application Path	C:\Program Files\Internet Explorer
Language	English (United States)
Active Printer	Not Available

Cipher Strength 56-bit

Appendix C – Tunable Parameters

Content AdvisorDisabled
IEAK Install No

[File Versions]

File	Version	Size	Date	Path	Company
advapi32.dll	5.0.2191.1	349 KB	12/7/1999 7:00:00 AM	C:\WINNT\system32	Microsoft Corporation
advapi32.dll	5.0.2191.1	349 KB	12/7/1999 7:00:00 AM	.	Microsoft Corporation
advpack.dll	5.0.2920.0	87 KB	12/7/1999 7:00:00 AM	C:\WINNT\system32	Microsoft Corporation
advpack.dll	5.0.2920.0	87 KB	12/7/1999 7:00:00 AM	.	Microsoft Corporation
browsecl.dll	5.0.2920.0	35 KB	12/7/1999 7:00:00 AM	C:\WINNT\system32	Microsoft Corporation
browsecl.dll	5.0.2920.0	35 KB	12/7/1999 7:00:00 AM	.	Microsoft Corporation
browseui.dll	5.0.2920.0	793 KB	12/7/1999 7:00:00 AM	C:\WINNT\system32	Microsoft Corporation
browseui.dll	5.0.2920.0	793 KB	12/7/1999 7:00:00 AM	.	Microsoft Corporation
ckcnv.exe	5.0.2189.1	9 KB	12/7/1999 7:00:00 AM	C:\WINNT\system32	Microsoft Corporation
ckcnv.exe	5.0.2189.1	9 KB	12/7/1999 7:00:00 AM	.	Microsoft Corporation
comctl32.dll	5.81.2920.0	540 KB	12/7/1999 7:00:00 AM	C:\WINNT\system32	Microsoft Corporation
comctl32.dll	5.81.2920.0	540 KB	12/7/1999 7:00:00 AM	.	Microsoft Corporation
crypt32.dll	5.131.2173.1	466 KB	12/7/1999 7:00:00 AM	C:\WINNT\system32	Microsoft Corporation
crypt32.dll	5.131.2173.1	466 KB	12/7/1999 7:00:00 AM	.	Microsoft Corporation
ehsig.dll	<File Missing>	Not Available	Not Available	Not Available	Not Available
iemigrat.dll	<File Missing>	Not Available	Not Available	Not Available	Not Available
iesetup.dll	5.0.2920.0	57 KB	12/7/1999 7:00:00 AM	C:\WINNT\system32	Microsoft Corporation
iesetup.dll	5.0.2920.0	57 KB	12/7/1999 7:00:00 AM	.	Microsoft Corporation
iexplore.exe	5.0.2920.0	59 KB	12/7/1999 7:00:00 AM	C:\Program Files\Internet Explorer	Microsoft Corporation
imagehlp.dll	5.0.2195.1	125 KB	12/7/1999 7:00:00 AM	C:\WINNT\system32	Microsoft Corporation
imagehlp.dll	5.0.2195.1	125 KB	12/7/1999 7:00:00 AM	.	Microsoft Corporation
imghelp.dll	<File Missing>	Not Available	Not Available	Not Available	Not Available
inseng.dll	5.0.2920.0	72 KB	12/7/1999 7:00:00 AM	C:\WINNT\system32	Microsoft Corporation
inseng.dll	5.0.2920.0	72 KB	12/7/1999 7:00:00 AM	.	Microsoft Corporation
jobexec.dll	5.0.0.1 47 KB	12/7/1999 7:00:00 AM	C:\WINNT\system32	Microsoft Corporation	Microsoft Corporation
jobexec.dll	5.0.0.1 47 KB	12/7/1999 7:00:00 AM	.	Microsoft Corporation	Microsoft Corporation
jscript.dll	5.1.0.4615	476 KB	12/7/1999 7:00:00 AM	C:\WINNT\system32	Microsoft Corporation
jscript.dll	5.1.0.4615	476 KB	12/7/1999 7:00:00 AM	.	Microsoft Corporation
jsproxy.dll	5.0.2920.0	13 KB	12/7/1999 7:00:00 AM	C:\WINNT\system32	Microsoft Corporation
jsproxy.dll	5.0.2920.0	13 KB	12/7/1999 7:00:00 AM	.	Microsoft Corporation
msaahtml.dll	<File Missing>	Not Available	Not Available	Not Available	Not Available
mshtml.dll	5.0.2920.0	2302 KB	12/7/1999 7:00:00 AM	C:\WINNT\system32	Microsoft Corporation
mshtml.dll	5.0.2920.0	2302 KB	12/7/1999 7:00:00 AM	.	Microsoft Corporation

Appendix C – Tunable Parameters

msjava.dll	5.0.3234.0	918 KB	12/7/1999 7:00:00 AM	C:\WINNT\system32	
	Microsoft Corporation				
msjava.dll	5.0.3234.0	918 KB	12/7/1999 7:00:00 AM	.	Microsoft Corporation
msoss.dll	<File Missing>	Not Available	Not Available	Not Available	Not Available
msxml.dll	5.0.2920.0	521 KB	12/7/1999 7:00:00 AM	C:\WINNT\system32	
	Microsoft Corporation				
msxml.dll	5.0.2920.0	521 KB	12/7/1999 7:00:00 AM	.	Microsoft Corporation
occache.dll	5.0.2920.0	86 KB	12/7/1999 7:00:00 AM	C:\WINNT\system32	
	Microsoft Corporation				
occache.dll	5.0.2920.0	86 KB	12/7/1999 7:00:00 AM	.	Microsoft Corporation
ole32.dll	5.0.2181.1	966 KB	12/7/1999 7:00:00 AM	C:\WINNT\system32	
	Microsoft Corporation				
ole32.dll	5.0.2181.1	966 KB	12/7/1999 7:00:00 AM	.	Microsoft Corporation
oleaut32.dll	2.40.4512.1	600 KB	12/7/1999 7:00:00 AM	C:\WINNT\system32	
	Microsoft Corporation				
oleaut32.dll	2.40.4512.1	600 KB	12/7/1999 7:00:00 AM	.	Microsoft Corporation
olepro32.dll	5.0.4512.1	160 KB	12/7/1999 7:00:00 AM	C:\WINNT\system32	
	Microsoft Corporation				
olepro32.dll	5.0.4512.1	160 KB	12/7/1999 7:00:00 AM	.	Microsoft Corporation
rsabase.dll	5.0.2150.1	129 KB	12/7/1999 7:00:00 AM	C:\WINNT\system32	
	Microsoft Corporation				
rsabase.dll	5.0.2150.1	129 KB	12/7/1999 7:00:00 AM	.	Microsoft Corporation
rsaenh.dll	<File Missing>	Not Available	Not Available	Not Available	Not Available
rsapi32.dll	<File Missing>	Not Available	Not Available	Not Available	Not Available
rsasig.dll	<File Missing>	Not Available	Not Available	Not Available	Not Available
schannel.dll	5.0.2170.0	140 KB	12/7/1999 7:00:00 AM	C:\WINNT\system32	
	Microsoft Corporation				
schannel.dll	5.0.2170.0	140 KB	12/7/1999 7:00:00 AM	.	Microsoft Corporation
shdoc401.dll	<File Missing>	Not Available	Not Available	Not Available	Not Available
shdocvw.dll	5.0.2920.0	1078 KB	12/7/1999 7:00:00 AM	C:\WINNT\system32	
	Microsoft Corporation				
shdocvw.dll	5.0.2920.0	1078 KB	12/7/1999 7:00:00 AM	.	Microsoft Corporation
shell32.dll	5.0.2920.0	2297 KB	12/7/1999 7:00:00 AM	C:\WINNT\system32	
	Microsoft Corporation				
shell32.dll	5.0.2920.0	2297 KB	12/7/1999 7:00:00 AM	.	Microsoft Corporation
shlwapi.dll	5.0.2920.0	283 KB	12/7/1999 7:00:00 AM	C:\WINNT\system32	
	Microsoft Corporation				
shlwapi.dll	5.0.2920.0	283 KB	12/7/1999 7:00:00 AM	.	Microsoft Corporation
url.dll	5.0.2920.0	82 KB	12/7/1999 7:00:00 AM	C:\WINNT\system32	Microsoft Corporation
	Microsoft Corporation				
url.dll	5.0.2920.0	82 KB	12/7/1999 7:00:00 AM	.	Microsoft Corporation
urlmon.dll	5.0.2920.0	427 KB	12/7/1999 7:00:00 AM	C:\WINNT\system32	
	Microsoft Corporation				
urlmon.dll	5.0.2920.0	427 KB	12/7/1999 7:00:00 AM	.	Microsoft Corporation
vbscript.dll	5.1.0.4615	428 KB	12/7/1999 7:00:00 AM	C:\WINNT\system32	
	Microsoft Corporation				
vbscript.dll	5.1.0.4615	428 KB	12/7/1999 7:00:00 AM	.	Microsoft Corporation
webcheck.dll	5.0.2920.0	252 KB	12/7/1999 7:00:00 AM	C:\WINNT\system32	
	Microsoft Corporation				
webcheck.dll	5.0.2920.0	252 KB	12/7/1999 7:00:00 AM	.	Microsoft Corporation
win.com	5.0.2134.1	24 KB	12/7/1999 7:00:00 AM	C:\WINNT\system32	
	Microsoft Corporation				
win.com	5.0.2134.1	24 KB	12/7/1999 7:00:00 AM	.	Microsoft Corporation

Appendix C – Tunable Parameters

wininet.dll	5.0.2920.0	457 KB	12/7/1999 7:00:00 AM	C:\WINNT\system32				
	Microsoft Corporation							
wininet.dll	5.0.2920.0	457 KB	12/7/1999 7:00:00 AM	.	Microsoft Corporation			
winsock.dll	3.10.0.103	3 KB	12/7/1999 7:00:00 AM	C:\WINNT\system32				
	Microsoft Corporation							
winsock.dll	3.10.0.103	3 KB	12/7/1999 7:00:00 AM	.	Microsoft Corporation			
wintrust.dll	5.131.2143.1	162 KB	12/7/1999 7:00:00 AM	C:\WINNT\system32				
	Microsoft Corporation							
wintrust.dll	5.131.2143.1	162 KB	12/7/1999 7:00:00 AM	.	Microsoft Corporation			
wsock.vxd	<File Missing>	Not Available	Not Available	Not Available	Not Available			
wsock32.dll	5.0.2152.1	21 KB	12/7/1999 7:00:00 AM	C:\WINNT\system32				
	Microsoft Corporation							
wsock32.dll	5.0.2152.1	21 KB	12/7/1999 7:00:00 AM	.	Microsoft Corporation			
wsock32n.dll	<File Missing>	Not Available	Not Available	Not Available	Not Available			

[Connectivity]

Item	Value
Connection Preference	Never dial
EnableHttp1.1	1
ProxyHttp1.1	0

LAN Settings

AutoConfigProxy	Not Available
AutoProxyDetectMode	Enabled
AutoConfigURL	
Proxy	Disabled
ProxyServer	
ProxyOverride	

[Cache]

[Following are sub-categories of this main category]

[Summary]

Item	Value
Page Refresh Type	Automatic
Temporary Internet Files Folder	C:\Documents and Settings\Administrator\Local Settings\Temporary Internet Files
Total Disk Space	4345 MB
Available Disk Space	1008 MB
Maximum Cache Size	135 MB
Available Cache Size	135 MB

[List of Objects]

Program File	Status	CodeBase
No cached object information available		

[Content]

[Following are sub-categories of this main category]

Appendix C – Tunable Parameters

[Summary]

Item	Value
Content Advisor	Disabled

[Personal Certificates]

Issued To	Issued By	Validity	Signature Algorithm
Administrator	Administrator	2/16/2001 to 1/23/2101	sha1RSA

[Other People Certificates]

Issued To	Issued By	Validity	Signature Algorithm
No other people certificate information available			

[Publishers]

Name
No publisher information available

[Security]

Zone	Security Level
Local intranet	Medium-low
Trusted sites	Low
Internet	Medium
Restricted sites	High

[Applications]

[Microsoft Word 2000]

[Summary]

Item	Value
Microsoft Word 2000	Microsoft Word 2000 has not been started or is not installed. Install and/or start application then press F5 to refresh.

[Active Document]

Item	Value
Microsoft Word 2000	Microsoft Word 2000 has not been started or is not installed. Install and/or start application then press F5 to refresh.

[Fields]

Item	Value
Microsoft Word 2000	Microsoft Word 2000 has not been started or is not installed. Install and/or start application then press F5 to refresh.

[File Converters]

Appendix C – Tunable Parameters

Item Value

Microsoft Word 2000 has not been started or is not installed. Install and/or start application then press F5 to refresh.

[Fonts]

Item Value

Microsoft Word 2000 has not been started or is not installed. Install and/or start application then press F5 to refresh.

[Headers and Footers]

Item Value

Microsoft Word 2000 has not been started or is not installed. Install and/or start application then press F5 to refresh.

[Hyperlinks]

Item Value

Microsoft Word 2000 has not been started or is not installed. Install and/or start application then press F5 to refresh.

[Mail Merge]

Item Value

Microsoft Word 2000 has not been started or is not installed. Install and/or start application then press F5 to refresh.

[Page Numbers]

Item Value

Microsoft Word 2000 has not been started or is not installed. Install and/or start application then press F5 to refresh.

[Page Setup]

Item Value

Microsoft Word 2000 has not been started or is not installed. Install and/or start application then press F5 to refresh.

[Styles]

Item Value

Microsoft Word 2000 has not been started or is not installed. Install and/or start application then press F5 to refresh.

[Settings]

Item Value

Microsoft Word 2000 has not been started or is not installed. Install and/or start application then press F5 to refresh.

[Tables]

Appendix C – Tunable Parameters

Item Value

Microsoft Word 2000 has not been started or is not installed. Install and/or start application then press F5 to refresh.

[Microsoft Excel 2000]

[Summary]

Item Value

Microsoft Excel 2000 has not been started or is not installed. Install and/or start application then press F5 to refresh.

[Active Workbook]

Item Value

Microsoft Excel 2000 has not been started or is not installed. Install and/or start application then press F5 to refresh.

[Add-Ins]

Item Value

Microsoft Excel 2000 has not been started or is not installed. Install and/or start application then press F5 to refresh.

[Charts in Active Workbook]

Item Value

Microsoft Excel 2000 has not been started or is not installed. Install and/or start application then press F5 to refresh.

[Microsoft PowerPoint 2000]

[Summary]

Item Value

Microsoft PowerPoint 2000 has not been started or is not installed. Install and/or start application then press F5 to refresh.

[Active Presentation]

Item Value

Microsoft PowerPoint 2000 has not been started or is not installed. Install and/or start application then press F5 to refresh.

[Microsoft Outlook 2000]

[Summary]

Item Value

Appendix C – Tunable Parameters

Microsoft Outlook 2000 has not been started or is not installed. Install and/or start application then press F5 to refresh.

[Microsoft Access 2000]

[Summary]

Item Value

Microsoft Access 2000 has not been started or is not installed. Install and/or start application then press F5 to refresh.

[Microsoft Publisher 2000]

[Summary]

Item Value

Microsoft Publisher 2000 has not been started or is not installed. Install and/or start application then press F5 to refresh.

[Microsoft FrontPage 2000]

[Summary]

Item Value

Microsoft FrontPage 2000 has not been started or is not installed. Install and/or start application then press F5 to refresh.

[Active Web]

Item Value

Microsoft FrontPage 2000 has not been started or is not installed. Install and/or start application then press F5 to refresh.

[Active Page]

Item Value

Microsoft FrontPage 2000 has not been started or is not installed. Install and/or start application then press F5 to refresh.

[COM Add-Ins]

Item Value

Microsoft FrontPage 2000 has not been started or is not installed. Install and/or start application then press F5 to refresh.

[Themes]

Item Value

Appendix C – Tunable Parameters

Microsoft FrontPage 2000 has not been started or is not installed. Install and/or start application then press F5 to refresh.

[Microsoft Office Environment]

[Last Web Connection Error]

Item Value
No error messages have been generated

[Local Web Server Extensions]

Item Value
Server type msiis
Port number /LM/W3SVC/1:
Version 4.0.2.3406
Path C:\Program Files\Common Files\Microsoft Shared\Web Server Extensions\40

[Transport]

Item Value
Microsoft OLE DB Provider for Internet Publishing True
Microsoft Office Internet Publishing False

[ODBC Drivers]

[Core Components]

Item Value
Description Administrator
Version 3.520.6526.0
File C:\WINNT\System32\odbccp32.dll

Description Control Panel Device
Version 3.520.6526.0
File C:\WINNT\System32\odbccp32.cpl

Description Control Panel Startup
Version 3.520.6526.0
File C:\WINNT\System32\odbcad32.exe

Description Cursor Library
Version 3.520.6526.0
File C:\WINNT\System32\odbccr32.dll

Description Driver Manager
Version 3.520.6526.0
File C:\WINNT\System32\odbc32.dll

Description Localized Resource DLL

Appendix C – Tunable Parameters

Version 3.520.6526.0
File C:\WINNT\System32\odbcint.dll

Description Unicode Cursor Library
Version 3.520.6526.0
File C:\WINNT\System32\odbccu32.dll

[Drivers]

Item Value
Name SQL Server
File SQLSRV32.dll
Date 8/6/2000 2:51:44 AM
Version 2000.80.194.0

Name Microsoft Access Driver (*.mdb)
File odbccjt32.dll
Date 12/7/1999 7:00:00 AM
Version 4.0.4403.2

Name Microsoft Text Driver (*.txt; *.csv)
File odbccjt32.dll
Date 12/7/1999 7:00:00 AM
Version 4.0.4403.2

Name Microsoft Excel Driver (*.xls)
File odbccjt32.dll
Date 12/7/1999 7:00:00 AM
Version 4.0.4403.2

Name Microsoft dBase Driver (*.dbf)
File odbccjt32.dll
Date 12/7/1999 7:00:00 AM
Version 4.0.4403.2

Name Microsoft Paradox Driver (*.db)
File odbccjt32.dll
Date 12/7/1999 7:00:00 AM
Version 4.0.4403.2

Name Microsoft Visual FoxPro Driver
File vfpodbc.dll
Date 12/7/1999 7:00:00 AM
Version 6.1.8629.1

Name Microsoft FoxPro VFP Driver (*.dbf)
File vfpodbc.dll
Date 12/7/1999 7:00:00 AM
Version 6.1.8629.1

Name Microsoft dBase VFP Driver (*.dbf)
File vfpodbc.dll
Date 12/7/1999 7:00:00 AM
Version 6.1.8629.1

Appendix C – Tunable Parameters

Name Microsoft Access-Treiber (*.mdb)
File odbcjt32.dll
Date 12/7/1999 7:00:00 AM
Version 4.0.4403.2

Name Microsoft Text-Treiber (*.txt; *.csv)
File odbcjt32.dll
Date 12/7/1999 7:00:00 AM
Version 4.0.4403.2

Name Microsoft Excel-Treiber (*.xls)
File odbcjt32.dll
Date 12/7/1999 7:00:00 AM
Version 4.0.4403.2

Name Microsoft dBase-Treiber (*.dbf)
File odbcjt32.dll
Date 12/7/1999 7:00:00 AM
Version 4.0.4403.2

Name Microsoft Paradox-Treiber (*.db)
File odbcjt32.dll
Date 12/7/1999 7:00:00 AM
Version 4.0.4403.2

Name Microsoft Visual FoxPro-Treiber
File vfpodbc.dll
Date 12/7/1999 7:00:00 AM
Version 6.1.8629.1

Name Driver do Microsoft Access (*.mdb)
File odbcjt32.dll
Date 12/7/1999 7:00:00 AM
Version 4.0.4403.2

Name Driver da Microsoft para arquivos texto (*.txt; *.csv)
File odbcjt32.dll
Date 12/7/1999 7:00:00 AM
Version 4.0.4403.2

Name Driver do Microsoft Excel(*.xls)
File odbcjt32.dll
Date 12/7/1999 7:00:00 AM
Version 4.0.4403.2

Name Driver do Microsoft dBase (*.dbf)
File odbcjt32.dll
Date 12/7/1999 7:00:00 AM
Version 4.0.4403.2

Name Driver do Microsoft Paradox (*.db)
File odbcjt32.dll
Date 12/7/1999 7:00:00 AM
Version 4.0.4403.2

Appendix C – Tunable Parameters

Name Driver para o Microsoft Visual FoxPro
File vfpodbc.dll
Date 12/7/1999 7:00:00 AM
Version 6.1.8629.1

Name Microsoft ODBC for Oracle
File msorcl32.dll
Date 7/26/2000 4:37:04 PM
Version 2.573.6526.0

[OLE DB Providers]

Item	Value
Microsoft OLE DB Provider for SQL Server	2000.80.194.0
MSDataShape	2.60.6526.0
OLE DB Provider for Microsoft Directory Services	5.0.2172.1
Microsoft OLE DB Provider for OLAP Services	7.0.1073.1114
Microsoft OLE DB Provider for OLAP Services	7.0.1073.1114
Microsoft OLE DB Provider for Internet Publishing	8.103.2016.0
Microsoft OLE DB Provider for ODBC Drivers	2.60.6526.0
Microsoft OLE DB Enumerator for ODBC Drivers	2.60.6526.0
Microsoft Jet 4.0 OLE DB Provider	4.0.2927.2
Microsoft OLE DB Enumerator for SQL Server	2000.80.194.0
Microsoft OLE DB Simple Provider	2.60.6526.0
Microsoft OLE DB Provider for Oracle	2.60.6526.0
Microsoft OLE DB Provider for Indexing Service	5.0.2135.1

RTE Input Parameters

BenchCraft Configuration File

Profile: 912_12_1_01
File Path: C:\benchcrf_421\912_12_1_01.pro
Version: 1.0.1

Number of Engines: 6

Name: DRIVER2A
Description: RTE1
Directory: c:\tpcclog\rte2a.log
Machine: RTE1
Parameter Set: PARAM2
Index: 0
Seed: 98176
Configured Users: 1520
Pipe Name: DRIVER43501360
Connect Rate: 2000
Start Rate: 0
CLIENT_NURAND: 208
CPU: 0

Appendix C – Tunable Parameters

Name: DRIVER2B
Description: RTE2
Directory: c:\tpcclog\rte2b.log
Machine: RTE2
Parameter Set: PARAM2
Index: 100000000
Seed: 98176
Configured Users: 1520
Pipe Name: DRIVER40641161
Connect Rate: 2000
Start Rate: 0
CLIENT_NURAND: 208
CPU: 0

Name: DRIVER3A
Description: RTE3
Directory: c:\tpcclog\rte3a.log
Machine: RTE3
Parameter Set: PARAM2
Index: 200000000
Seed: 98176
Configured Users: 1520
Pipe Name: DRIVER371721555
Connect Rate: 2000
Start Rate: 0
CLIENT_NURAND: 208
CPU: 0

Name: DRIVER3B
Description: RTE4
Directory: c:\tpcclog\rte3b.log
Machine: RTE4
Parameter Set: PARAM2
Index: 300000000
Seed: 98176
Configured Users: 1520
Pipe Name: DRIVER341837462
Connect Rate: 2000
Start Rate: 0
CLIENT_NURAND: 208
CPU: 0

Name: DRIVER4A
Description: RTE5
Directory: c:\tpcclog\rte4a.log
Machine: RTE5
Parameter Set: PARAM2
Index: 400000000
Seed: 98176
Configured Users: 1520
Pipe Name: DRIVER311984373
Connect Rate: 2000
Start Rate: 0
CLIENT_NURAND: 208

Appendix C – Tunable Parameters

CPU: 0

Name: DRIVER4B
Description: RTE6
Directory: c:\tpcclog\rte4b.log
Machine: RTE6
Parameter Set: PARAM2
Index: 500000000
Seed: 98176
Configured Users: 1520
Pipe Name: DRIVER282107740
Connect Rate: 2000
Start Rate: 0
CLIENT_NURAND: 208
CPU: 0

Number of User groups: 12

Driver Engine: DRIVER2A
IIS Server: CLIENT3_1
SQL Server: PE2500
User: sa
Protocol: Html
w_id Range: 1 - 76
w_id Max Warehouse: 912
Scale: Normal
User Count: 760
District id: 1
Scale Down: No

Driver Engine: DRIVER4A
IIS Server: CLIENT3_2
SQL Server: PE2500
User: sa
Protocol: Html
w_id Range: 685 - 760
w_id Max Warehouse: 912
Scale: Normal
User Count: 760
District id: 1
Scale Down: No

Driver Engine: DRIVER4B
IIS Server: CLIENT3_1
SQL Server: PE2500
User: sa
Protocol: Html
w_id Range: 761 - 836
w_id Max Warehouse: 912
Scale: Normal
User Count: 760
District id: 1
Scale Down: No

Driver Engine: DRIVER4B

Appendix C – Tunable Parameters

IIS Server: CLIENT3_2
SQL Server: PE2500
User: sa
Protocol: Html
w_id Range: 837 - 912
w_id Max Warehouse: 912
Scale: Normal
User Count: 760
District id: 1
Scale Down: No

Driver Engine: DRIVER2A
IIS Server: CLIENT3_2
SQL Server: PE2500
User: sa
Protocol: Html
w_id Range: 77 - 152
w_id Max Warehouse: 912
Scale: Normal
User Count: 760
District id: 1
Scale Down: No

Driver Engine: DRIVER2B
IIS Server: CLIENT3_1
SQL Server: PE2500
User: sa
Protocol: Html
w_id Range: 153 - 228
w_id Max Warehouse: 912
Scale: Normal
User Count: 760
District id: 1
Scale Down: No

Driver Engine: DRIVER2B
IIS Server: CLIENT3_2
SQL Server: PE2500
User: sa
Protocol: Html
w_id Range: 229 - 304
w_id Max Warehouse: 912
Scale: Normal
User Count: 760
District id: 1
Scale Down: No

Driver Engine: DRIVER3A
IIS Server: CLIENT3_1
SQL Server: PE2500
User: sa
Protocol: Html
w_id Range: 305 - 380
w_id Max Warehouse: 912
Scale: Normal

Appendix C – Tunable Parameters

User Count: 760
District id: 1
Scale Down: No

Driver Engine: DRIVER3A
IIS Server: CLIENT3_2
SQL Server: PE2500
User: sa
Protocol: Html
w_id Range: 381 - 456
w_id Max Warehouse: 912
Scale: Normal
User Count: 760
District id: 1
Scale Down: No

Driver Engine: DRIVER3B
IIS Server: CLIENT3_1
SQL Server: PE2500
User: sa
Protocol: Html
w_id Range: 457 - 532
w_id Max Warehouse: 912
Scale: Normal
User Count: 760
District id: 1
Scale Down: No

Driver Engine: DRIVER3B
IIS Server: CLIENT3_2
SQL Server: PE2500
User: sa
Protocol: Html
w_id Range: 533 - 608
w_id Max Warehouse: 912
Scale: Normal
User Count: 760
District id: 1
Scale Down: No

Driver Engine: DRIVER4A
IIS Server: CLIENT3_1
SQL Server: PE2500
User: sa
Protocol: Html
w_id Range: 609 - 684
w_id Max Warehouse: 912
Scale: Normal
User Count: 760
District id: 1
Scale Down: No

Number of Parameter Sets: 6

Appendix C – Tunable Parameters

50 run

New Parameter Set

	Txn	Think	Key	RT	RT	Menu	
	Weight	Time	Time	Delay	Fence	Delay	
New Order	44.86	30.00	18.02	0.10	5.00	0.10	
Payment	43.05	30.00	3.02	0.10	5.00	0.10	
Delivery	4.03	15.00	2.02	0.10	5.00	0.10	
Stock Level	4.03	15.00	2.02	0.10	20.00	0.10	
Order Status	4.03	25.00	2.02	0.10	5.00	0.10	

~Default

Default Parameter Set

	Txn	Think	Key	RT	RT	Menu	
	Weight	Time	Time	Delay	Fence	Delay	
New Order	10.00	12.05	18.01	0.10	5.00	0.10	
Payment	10.00	12.05	3.01	0.10	5.00	0.10	
Delivery	1.00	5.05	2.01	0.10	5.00	0.10	
Stock Level	1.00	5.05	2.01	0.10	20.00	0.10	
Order Status	1.00	10.05	2.01	0.10	5.00	0.10	

PARAM2

Slightly tweaked parameter set

	Txn	Think	Key	RT	RT	Menu	
	Weight	Time	Time	Delay	Fence	Delay	
New Order	44.84	12.04	18.02	0.10	5.00	0.10	
Payment	43.04	12.04	3.02	0.10	5.00	0.10	
Delivery	4.04	5.04	2.02	0.10	5.00	0.10	
Stock Level	4.04	5.04	2.02	0.10	20.00	0.10	
Order Status	4.04	10.04	2.02	0.10	5.00	0.10	

PARAM3

New Parameter Set

	Txn	Think	Key	RT	RT	Menu	
	Weight	Time	Time	Delay	Fence	Delay	
New Order	44.86	12.04	18.02	0.10	5.00	0.10	
Payment	43.05	12.04	3.02	0.10	5.00	0.10	
Delivery	4.03	5.04	2.02	0.10	5.00	0.10	
Stock Level	4.03	5.04	2.02	0.10	20.00	0.10	
Order Status	4.03	10.04	2.02	0.10	5.00	0.10	

50 run2

New Parameter Set

	Txn	Think	Key	RT	RT	Menu	
	Weight	Time	Time	Delay	Fence	Delay	
New Order	44.86	32.00	18.02	0.10	5.00	0.10	
Payment	43.05	32.00	3.02	0.10	5.00	0.10	
Delivery	4.03	17.00	2.02	0.10	5.00	0.10	
Stock Level	4.03	17.00	2.02	0.10	20.00	0.10	
Order Status	4.03	27.00	2.02	0.10	5.00	0.10	

80 run

New Parameter Set

	Txn	Think	Key	RT	RT	Menu	
	Weight	Time	Time	Delay	Fence	Delay	
New Order	44.86	18.00	18.02	0.10	5.00	0.10	

Appendix C – Tunable Parameters

Payment	43.05	18.00	3.02	0.10	5.00	0.10
Delivery	4.03	13.00	2.02	0.10	5.00	0.10
Stock Level	4.03	13.00	2.02	0.10	20.00	0.10
Order Status	4.03	8.00	2.02	0.10	5.00	0.10

Appendix D – Tunable Parameters

Appendix D – Disk Storage

Warehouses	1100				TpmC	11,314.11
Table	Rows	Data KB	Index KB	Extra 5% KB	8hr Space	Total Space KB
Warehouse	1,100	120	24	7		151
District	11,000	1,224	24	62		1,310
Customer	33,000,000	24,000,008	1,431,192	1,271,560		26,702,760
History	33,000,000	1,833,344	48		301,883	1,833,392
NewOrder	9,900,000	156,528	368	7,845		164,741
Orders	33,000,000	1,011,496	459,976		242,284	1,471,472
OrderLine	329,998,919	20,624,936	43,672		3,403,186	20,668,608
Item	100,000	9,528	40	478		10,046
Stock	110,000,000	35,200,008	65,816	1,763,291		37,029,115
Total		82,837,192	2,001,160	3,043,244	3,947,353	87,881,596
		MB				
Dynamic Space	22,920	Sum of Data for Order, Orderline and History				
Static Space	62,902	Sum of Data+Index+5%-Dynamic Space				
Free Space	na	Total Allocated Spac - (Dynamic + Static Space)				
Daily Growth	3,772	(Dynamic Space/(W*62.5))*tpmc				
Daily Spread	-	(Free Space -1.5*Daily Growth) Zero Assumed				
60 Day Space MB	289,214					
60 Day Space GB	282.44	GB				
Log Size	34,303.99	MB				
KB Per New Order	5.31	KB				
8 hr log MB	28,155	MB				
8 hr log GB	27.4953	GB				
		Disks	Disks	Formatted Size	Space	
Space Usage	GB Needed	Measured	Size	Size	Available	
180 Day Space DB	282.44	0	18GB	16.900	0.00	
		48	9GB	8.473	406.69	
			4GB	3.999	0.00	
Total DB		48.00			406.69	
8-hr log + mirror	54.9906	4	18GB	16.900	67.60	
OS, Swap	3	1	18GB	16.900	16.90	
Total Storage	340.43	GB			491.19	

Appendix E - Price Quotations

Appendix E - Price Quotations

Model	Description	Original Price	Current Price	Shipping	Quantity
CBL510	10FT Cat 5 Cable up to 100MBPS MOLDED	\$2.00	\$1.48	\$5.95 (Shipping covers up to 6 cables)	4=1 LI
CLBL514	14FT Cat 5 Cable 100MBPS MOLDED	\$2.00	\$1.72	\$5.95 (Shipping covers up to 6 cables)	3=1 LI
CBL525	25 FT Cat 5 Cable 100MBPS MOLDED	\$3.00	\$2.34	\$5.95 (Shipping covers up to 3 cables)	5= 3LI
CBL525e (available in white only)	25 FT Cat 5 Cable Enhanced 350MHZ MOLDED	\$4.00	-	\$5.95 (Shipping covers up to 3 cables)	5= 3LI
CBL535	35FT Cat 5 Cable 100MBPS MOLDED	\$5.00	-	\$5.95	
CBL550e (Available in white only)	50 FT Cat 5 Cable Enhanced 350MHZ MOLDED	\$6.00	-	\$5.95	5=6 LI
CBL570	70FT Cat 5			\$5.95	7=12 LI

Appendix E - Price Quotations

Computer Giants Inc.

168 Madison Ave
7th Floor
NY, NY

Estimate

Date	Estimate #
11/16/2001	113

Name / Address

DELL COMPUTER CORPORATION
BENZAMIN ` TANG
ONE DELL WAY
ROUND ROCK, TX 78682

Project

Description	Qty	Cost	Total	
ACCELERAID A352 2 CHANNEL PCI U160 SCSI 32MB	5	595.00	2,975.00	T
WILL CALL	1	0.00	0.00	T

We appreciate your business
Valid for 90 days

Subtotal	\$2,975.00
Sales Tax	() \$0.00
Total	\$2,975.00

For Warranty information go to :
http://www.computergiants.com/items/one_item.asp?part=3681&cat=33&subsubcat=292

Appendix E - Price Quotations

Microsoft Corporation
One Microsoft Way
Redmond, WA 98052-6399

Tel 425 882 8080
Fax 425 936 7329
<http://www.microsoft.com/>

Microsoft

October 23, 2001

Dell Computer Corporation
Nicholas Wakou
RR5
One DellWay
Round Rock, TX 787682

Nicholas:

Here is the information you requested regarding pricing for several Microsoft products to be used in conjunction with your TPC-C V5.0 benchmark testing.

All pricing shown is in US Dollars (\$).

Part Number	Description	Unit Price	Quantity	Price
228-01079	SQL Server 2000 Standard Edition <i>Per processor licensing</i>	\$ 4,999	1	\$ 4,999
C11-00821	Windows 2000 Server <i>Server license only - No CALs</i> <i>Discount schedule: Open Program - No Level</i>	\$ 738	1	\$ 738
048-00317	Visual C++ Professional 6.0 Win32	\$ 549	1	\$ 549
	3-year maintenance for above software	\$ 2,095	1	\$ 6,285

All products are currently orderable through Microsoft's normal distribution channels.

This quote is valid for the next 90 days.

If we can be of any further assistance, please contact Jamie Reding at (425) 703-0510 or jamiere@microsoft.com.

Reference ID: Prdaf0123106928

Please include this Reference ID in any correspondence regarding this price quote.