

TPC Benchmark™ H Full Disclosure Report

IBM @server p5 570

Using

IBM DB2 Universal Database V8.2

First Edition
September 15, 2004

The following terms used in this publication are trademarks of their respective companies as follows:

Trademark of the Transaction Processing Performance Council:

TPC Benchmark

TPC-H

QppH

QthH

QphH

Trademark of International Business Machines Corporation:

IBM

the IBM logo

@server

pSeries

POWER5

TotalStorage

AIX

AIX 5L

DB2

DB2 Universal Database

First Edition September 15, 2004

The information contained in this document has not been submitted to any formal test and is distributed on an AS IS basis without any warranty either expressed or implied. The use of this information or the implementation of any of these techniques is a customer's responsibility and depends on the customer's ability to evaluate and integrate them into the customer's operational environment. While each item has been reviewed by IBM for accuracy in a specific situation, there is no guarantee that the same or similar results will be obtained elsewhere. Customers attempting to adapt these techniques to their own environment do so at their own risk.

In this document, any references made to an IBM licensed program are not intended to state or imply that only IBM's licensed program may be used; any functionally equivalent program may be used.

It is possible that this material may contain references to, or information about, IBM products (machines and programs), programming, or services that are not announced in your country. Such references or information must not be construed to mean that IBM intends to announce such products, programming, or services in your country.

All performance data contained in this publication was obtained in a controlled environment, and therefore the results which may be obtained in other operating environments may vary significantly. Users of this document should verify the applicable data in their specific environment.

© Copyright International Business Machines 2004 All rights reserved.

Permission is hereby granted to reproduce this document in whole or in part, provided the copyright notice printed above is set forth in full text on the title page of each item reproduced.

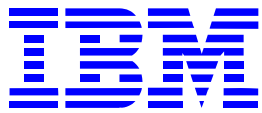

IBM @server p5 570 with DB2 UDB V8.2

TPC-H Rev. 2.1.0

Report Date: Sep. 15, 2004

Total System Cost	Composite Query per Hour Rating			Price/Performance
\$1,397,456	26,156.3 QphH@1000GB			53 \$/QphH@1000GB
Database Size	Database Manager	Operating System	Other Software	Availability Date
1000GB	DB2 UDB V8.2	AIX 5L V5.3	None	December 15, 2004

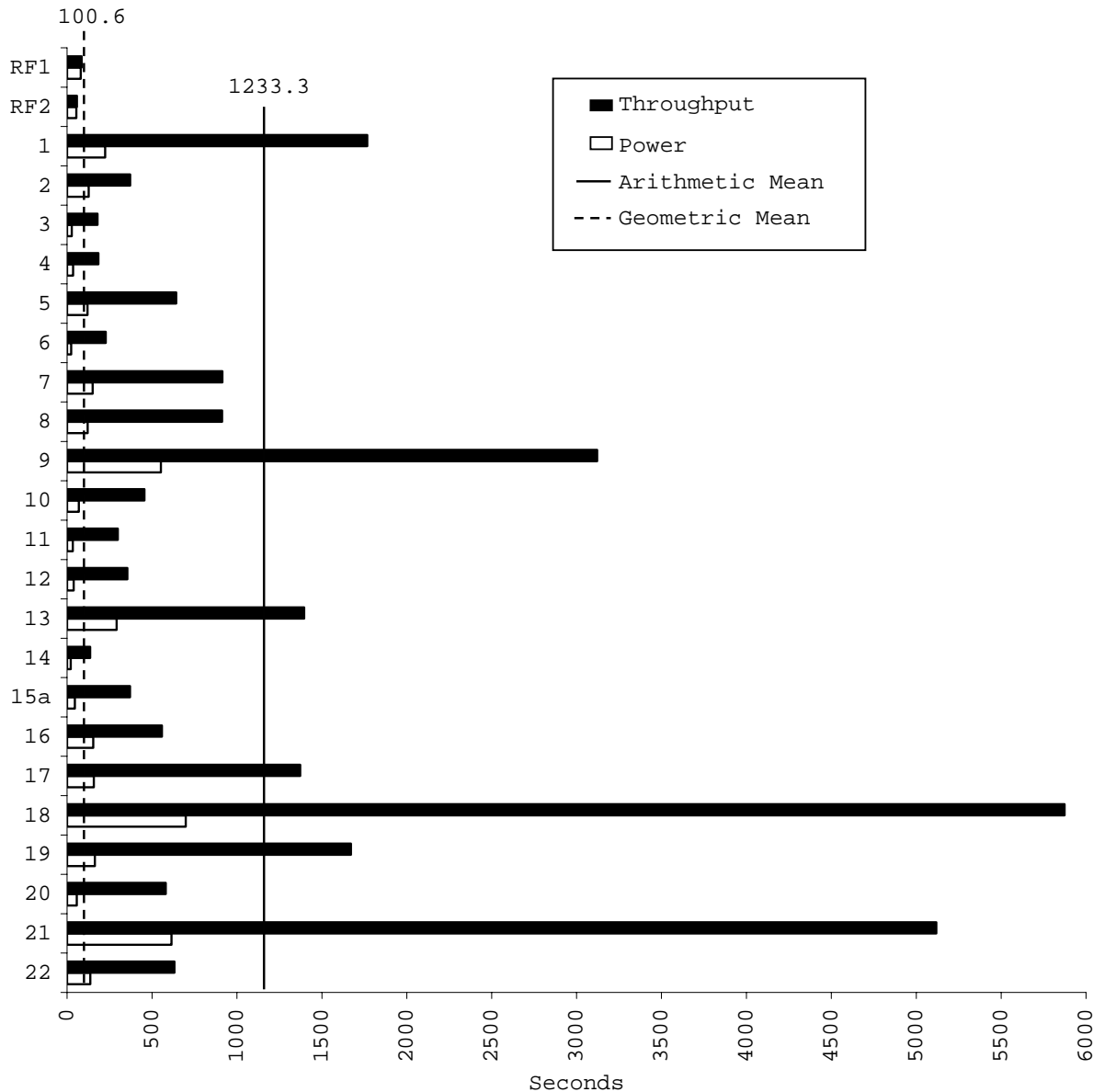

Database Load Time: 2:32:13	Load included backup: N	Total Data Storage/Database Size: 8.28
RAID (base tables): Y	RAID (Base Tables and Auxiliary Data Structures): Y	RAID (All): N

System Configurations
4 IBM @server p5 570 servers, each server with
Processors 4 x 1900MHz POWER5 with 2x 36MB L3 Cache
Memory 32GB
Disk Controllers 8 x 2Gigabit Fibre Channel PCI-X Adapter & 4 x IBM TotalStorage DS4300 dual controllers
Disk Drives 56 x 36.4GB 15K 2Gb FC drives ; 2 x 73.4GB 15K Ultra4 SCSI drives, with 2 additional on server1
Network 2 Integrated Gigabit Ethernet
Total Disk Storage 8,277.19 GB (GB is defined as 1024 * 1024 * 1024 bytes)

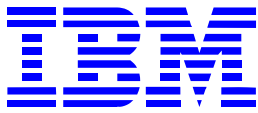

IBM @server p5 570 with DB2 UDB V8.2

TPC-H Rev. 2.1.0

Report Date: Sep. 15, 2004

Description	Part No.	Source	Unit Price	Qty	Ext Price	Maint Price
Server Hardware						
IBM eServer p5 9117 Model 570	9117-570	1	1,000	4	4,000	113,448
Headless Enclosure	7879	1	350	4	1,400	0
I/O Backplane	7866	1	4,100	4	16,400	0
System Midplane	7867	1	500	4	2,000	0
SCSI disk backplane	7868	1	1,200	4	4,800	0
Power Distribution Backplane	7870	1	200	4	800	0
Serial Port Riser Card	7878	1	100	4	400	0
Power Supply	7888	1	800	8	6,400	0
L4 1.9 Processor 0/2Way	7832	1	10,900	8	87,200	0
1-way Activation for 7832	7898	1	21,800	8	174,400	0
1-way Activation for 7832 - \$0 Priced Value Pack	8454	1	0	8	0	0
Media Backplane	7869	1	140	4	560	0
CEC Backplane	7865	1	1,200	4	4,800	0
L4 CPU Regulator	7875	1	1,100	12	13,200	0
L4 FSP Card	7881	1	650	4	2,600	0
IDE DVDROM, Slim Line	2640	1	378	4	1,512	0
8GB(4x2000MB)	4454	1	14,746	16	235,936	0
DASD 73.4 10K rpm	3274	1	1,400	10	14,000	0
Line Cords	6458	1	14	8	112	0
Op Panel	1846	1	150	4	600	0
Rack-mount Drawer Rail Kit	7164	1	168	4	672	0
Hardware Management Console	7315-C03	1	2,001	1	2,001	816
Model D20 I/O Drawer	7311-D20	1	4,270	8	34,160	30,336
Remote I/O Cable, 3.5M	3147	1	550	12	6,600	0
SPCN 2m Cable: Drawer to Drawer	6001	1	25	12	300	0
AC Power Supply, 435W	6268	1	625	8	5,000	0
RIO-2 Ports to I/O Planar Riser Card	6417	1	800	8	6,400	0
2 Gigabit Fibre Channel PCI-X Adapter	5716	1	2,267	32	72,544	0
Rack Model T00 - 7176, 6246, 6098	7014-T00	1	4,188	3	12,564	2,304
				Subtotal	711,361	146,904
Storage						
STORAGE SERVER DS4300	1722-60U	1	14,999	16	239,984	0
SHORT WAVE SFP GBIC	2210	1	499	32	15,968	0
2GB FC,36.4GB/15K DRIVE MOD.	5212	1	1,115	224	249,760	0
AIX HOST KIT	7711	1	4,000	1	4,000	0
Fiber Cable 25m	5625	1	189	32	6,048	0
3 Year Warranty Service Upgrade 1722 24x7x4	96P2368	1	2,499	16	0	39,984
				Subtotal	515,760	39,984
Server Software						
AIX 5.3 (media only)	5962-A5L	1	50	1	50	0
AIX Software	5765-AIX	1	1,225	16	19,600	0
AIX Software Maintanance (3Y)	5773-SM3	1	1,958	16	0	31,328
AIX Software Maintanance 24x7 Upgrade (3Y)	0468	1	496	16	0	7,936

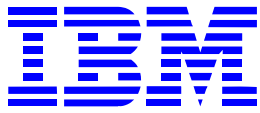

IBM @server p5 570 with DB2 UDB V8.2

TPC-H Rev. 2.1.0

Report Date: Sep. 15, 2004

HMC Software Support 3 Year	5773-RS3	1	675	1	0	675
HMC Software Support 24x7 3 Year	5773-0570	1	236	1	0	236
C for AIX user Lic+SW maint 12 MO	D5A1DLL	1	515	1	515	0
C for AIX user annual SW maint renewal	E1A1FLL	1	103	2	0	206
DB2 UDB ESE License/1-yr. Maint.	D518GLL	1	19,755	16	316,080	
DB2 UDB ESE Support 1Yr/Proc	E00BILL	1	940	32		30,080
DB2 UDB ESE DPF License/1-yr. Maint.	D518JLL	1	6,143	16	98,288	
DB2 UDB ESE DPF Support 1Yr/Proc	E00BJLL	1	293	32		9,376
Subtotal					434,533	79,837
Third Party Hardware/Software						
Cisco Catalyst WS-C3750G-24TS-S 10/100/1000	496453	2	5,129	1	5,129	
Cisco SMARTnet Onsite 1 Year 24x7 4 Hour	137978	2	1,298	3	0	3,894
Subtotal					5,129	3,894
Total					1,666,783	270,619
IBM Total System Discounts*						-539,946
Three-Year Cost of Ownership						1,397,456
QphH						26,157
\$/QphH						53

*Discounts are based on US list prices for similar quantities & configurations

Pricing Sources:

1 IBM: Bill Casey, eServer pSeries Offering Manager, wr Casey@us.ibm.com, 512-838-1422

1 IBM DB2: Paul Rivot, Director Database Servers Business Intelligence Software, email pivot@us.ibm.com, phone 914-766-1325

2 CDW.com

Audited by: Francois Raab of Infosizing (www.infosizing.com)

The system as configured for the test will be available December 15, 2004.

Prices used in TPC benchmarks reflect the actual prices a customer would pay for a one-time purchase of the stated components. Individually negotiated discounts are not permitted. Special prices based on assumptions about past or future purchases are not permitted. All discounts reflect standard pricing policies for the listed components. For complete details see the pricing sections of the TPC benchmark specifications. If you find the stated prices are not available according to these terms, please notify the TPC at pricing@tpc.org. Thank You.

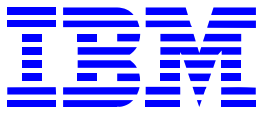

IBM @server p5 570
with **DB2 UDB V8.2**

TPC-H Rev. 2.1.0

Report Date: Sep. 15, 2004

Numerical Quantities Summary

Measurement Results

Database Scaling (SF/Size)	=	1000
Total Data Storage/Database Size	=	8.28
Start of Database Load	=	9/5/2004 23:37:25
End of Database Load	=	9/6/2004 2:09:38
Database Load Time	=	2:32:13
Query Streams for Throughput Test	=	7
TPC-H Power Metric (QppH@1000GB)	=	35,789.6
TPC-H Throughput Metric (QthH@1000GB)	=	19,115.9
Composite Query-per-Hour Rating (QphH@1000GB)	=	26,156.3
Total System Price over 3 years	=	\$1,397,456
TPC-H Price/Performance Metric (\$/QphH@1000GB)	=	53

Measurement Intervals

Measurement Interval in Throughput Test (Ts) = 29,002 seconds

Duration of Stream Execution

Stream Id	Seed Used	Start Date & Time	End Date & Time	Duration
Stream 00	906020938	9/6/2004 03:44:19	9/6/2004 04:50:04	1:05:45
Refresh		9/6/2004 03:44:19	9/6/2004 04:50:57	1:06:38
Stream 01	906020939	9/6/2004 04:51:21	9/6/2004 12:37:58	7:46:37
Stream 02	906020940	9/6/2004 04:51:21	9/6/2004 12:32:42	7:41:21
Stream 03	906020941	9/6/2004 04:51:22	9/6/2004 12:37:41	7:46:19
Stream 04	906020942	9/6/2004 04:51:23	9/6/2004 12:22:32	7:31:10
Stream 05	906020943	9/6/2004 04:51:23	9/6/2004 12:11:37	7:20:14
Stream 06	906020944	9/6/2004 04:51:23	9/6/2004 12:19:45	7:28:22
Stream 07	906020945	9/6/2004 04:51:23	9/6/2004 12:02:48	7:11:25
Refresh		9/6/2004 04:51:23	9/6/2004 12:54:43	8:03:21

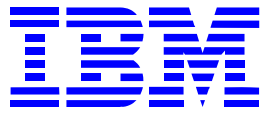

IBM @server p5 570
with DB2 UDB V8.2

TPC-H Rev. 2.1.0

Report Date: Sep. 15, 2004

Timing Interval (in seconds)

Stream ID	Q1	Q2	Q3	Q4	Q5	Q6	Q7	Q8	Q9	Q10	Q11	Q12
Stream 0	224.5	127.6	27.3	35.6	120.4	23.9	150.4	121.0	552.5	69.6	33.7	38.6
Stream 01	457.1	325.6	238.6	36.4	653.7	133.9	841.2	868.8	3168.3	348.7	288.7	350.5
Stream 02	1992.3	301.3	247.9	209.6	488.2	275.8	831.0	913.6	3544.9	414.9	326.7	805.3
Stream 03	1927.4	305.2	48.3	188.6	595.6	196.5	908.2	937.5	3199.9	489.7	314.1	62.9
Stream 04	2025.6	363.3	136.2	172.9	863.2	187.4	1007.8	844.9	3074.4	461.7	315.7	246.0
Stream 05	1997.5	404.8	200.6	255.8	523.4	276.9	1011.5	893.4	3105.4	495.2	287.6	267.4
Stream 06	1964.6	359.1	205.2	209.0	752.5	293.5	949.9	988.5	3040.0	528.0	296.1	288.4
Stream 07	2006.5	539.1	176.8	212.3	618.6	226.1	848.9	938.5	2711.3	446.0	258.2	461.6
Minimum	457.1	301.3	48.3	36.4	488.2	133.9	831.0	844.9	2711.3	348.7	258.2	62.9
Average	1767.3	371.2	179.1	183.5	642.2	227.2	914.1	912.2	3120.6	454.9	298.2	354.6
Maximum	2025.6	539.1	247.9	255.8	863.2	293.5	1011.5	988.5	3544.9	528.0	326.7	805.3
Stream ID	Q13	Q14	Q15a	Q16	Q17	Q18	Q19	Q20	Q21	Q22	RF1	RF2
Stream 0	291.6	20.8	45.9	154.2	157.1	698.2	163.6	56.3	614.8	136.0	80.9	53.8
Stream 01	1385.6	139.6	310.0	556.9	1416.3	8285.9	1679.6	594.5	5539.4	377.4	92.0	64.4
Stream 02	1110.3	105.2	518.2	641.4	1604.7	6317.5	1819.3	572.9	4071.1	568.3	86.0	68.2
Stream 03	921.1	139.0	248.8	269.2	1522.9	7382.2	1651.8	677.9	5303.4	688.7	87.1	49.2
Stream 04	1677.5	167.6	375.0	613.0	1311.7	5000.7	1913.2	307.8	5344.5	659.6	107.8	61.1
Stream 05	1627.3	127.7	343.0	549.1	1388.4	4452.7	1365.1	507.4	5556.7	777.7	70.5	66.8
Stream 06	1664.9	119.7	306.9	613.7	1301.3	4608.7	1602.3	703.9	5346.0	760.3	67.7	51.3
Stream 07	1388.4	147.5	489.1	664.5	1063.5	5064.5	1665.3	701.1	4661.0	596.1	86.4	46.1
Minimum	921.1	105.2	248.8	269.2	1063.5	4452.7	1365.1	307.8	4071.1	377.4	67.7	46.1
Average	1396.4	135.2	370.1	558.3	1372.7	5873.2	1670.9	580.8	5117.4	632.6	85.4	58.2
Maximum	1677.5	167.6	518.2	664.5	1604.7	8285.9	1913.2	703.9	5556.7	777.7	107.8	68.2

Benchmark Sponsor: Haider Rizvi
 Mgr., DB2 Data Warehouse Perf.
 IBM Canada Ltd;
 8200 Warden Avenue
 Markham, Ontario L6G 1C7

Tony Petrossian
 Mgr, pSeries Database Perf.
 IBM eServer Performance
 11501 Burnet Road
 Austin, TX 78758

September 13, 2004

I verified the TPC Benchmark™ H performance of the following configuration:

Platform: **IBM @server p5 570 4-node cluster**
 Database Manager: **IBM DB2 UDB V8.2**
 Operating System: **AIX 5L V5.3**

The results were:

CPU (Speed)	Memory	Disks	QphH@1000GB
IBM @server p5 570 4-node cluster (each node with)			
4 x POWER5 (1.9 GHz)	2 x 36 MB L3 32 GB Main	56 x 36.4 GB ext. 2 x 73.4 GB SCSI int.	26,156.3

In my opinion, this performance result was produced in compliance with the TPC's requirements for the benchmark. The following verification items were given special attention:

- The database records were defined with the proper layout and size
- The database population was generated using DBGEN
- The database was properly scaled to 1000GB and populated accordingly
- The compliance of the database auxiliary data structures was verified
- The database load time was correctly measured and reported
- The required ACID properties were verified and met
- The query input variables were generated by QGEN
- The query text was produced using minor modifications and an approved query variant

- The execution of the queries against the SF1 database produced compliant answers
- A compliant implementation specific layer was used to drive the tests
- The throughput tests involved 7 query streams
- The ratio between the longest and the shortest query was such that no query timing was adjusted
- The execution times for queries and refresh functions were correctly measured and reported
- The repeatability of the measured results was verified
- The required amount of database log was configured
- The system pricing was verified for major components and maintenance
- The major pages from the FDR were verified for accuracy

Additional Audit Notes:

None.

Respectfully Yours,

A handwritten signature in black ink, appearing to read "François Raab", with a long horizontal flourish extending to the right.

François Raab
President

<i>Preface</i>	2
1.0 General Items	4
1.1. Benchmark Sponsor	4
1.2. Parameter Settings	4
1.3. Configuration Diagrams	4
2.0 Clause 1: Logical Database Design Related Items	6
2.1. Table Definitions	6
2.2. Database Organization	6
2.3. Horizontal Partitioning	6
2.4. Replication	6
3.0 Clause 2: Queries and Refresh Functions	7
3.1. Query Language	7
3.2. Verification for the Random Number Generator	7
3.3. Substitution Parameters	7
3.3.1. Method of Generation	7
3.4. Query Text	7
3.5. Query Substitution Parameters and Seeds	8
3.6. Isolation Level	8
3.7. Refresh Functions	8
4.0 Clause 3: Database System Properties	9
4.1. Atomicity Requirements	9
4.1.1. Atomicity of Completed Transaction	9
4.1.2. Atomicity of Aborted Transactions	9
4.2. Consistency Requirements	10
4.2.1. Consistency Condition	10
4.2.2. Consistency Tests	10
4.3. Isolation Requirements	10
4.3.1. Isolation Test 1	10
4.3.2. Isolation Test 2	11
4.3.3. Isolation Test 3	11
4.3.4. Isolation Test 4	11
4.3.5. Isolation Test 5	12
4.3.6. Isolation Test 6	12
4.4. Durability Requirements	12
4.4.1. Permanent Failure of Single Durable Medium and Loss of System Power	13
4.4.2. Loss of Switch Power	13
4.4.3. Failure of Storage Controller, and Loss of System Power	14
5.0 Clause 4: Scaling and Database Population Related Items	15
5.1. Cardinality of Tables	15
5.2. Distribution of Tables and Logs	15
5.3. Mapping of Database Partitions/Replications	15
5.4. Implementation of RAID	16
5.5. DBGEN Modifications	16
5.6. Database Loading	16

5.7.	Data Storage Ratio	16
5.8.	Details of Database Loading	17
6.0	<i>Clause 5: Performance Metrics and Execution-Rules Related Items</i>	18
6.1.	System Activity Between Load and Performance Tests	18
6.2.	Steps in the Power Test	18
6.3.	Timing Intervals for Each Query and Refresh Function	18
6.4.	Number of Streams for the Throughput Test	18
6.5.	Start and End Date/Times for Each Query Stream	18
6.6.	Total Elapsed Time for the Measurement Interval	18
6.7.	Refresh Function Start Date/Time and Finish Date/Time	18
6.8.	Timing Intervals for Each Query and Each Refresh Function for Each Stream	19
6.9.	Performance Metrics	19
6.10.	The Performance Metric and Numerical Quantities from Both Runs	19
6.11.	System Activity Between Tests	19
7.0	<i>Clause 6: SUT and Driver Implementation</i>	20
7.1.	Driver	20
7.2.	Implementation Specific Layer	20
7.3.	Profile-Directed Optimization	21
8.0	<i>Clause 7: Pricing-Related Items</i>	22
8.1.	Hardware and Software Used	22
8.2.	Three Year Cost of System Configuration	22
8.3.	System Availability Date	22
9.0	<i>Clause 9: Audit Items</i>	24
<i>Appendix - A</i>	<i>Tunable Parameters</i>	25
A.1	DB2 Database Configuration	25
A.2	DB2 Database Manager Configuration	26
A.3	DB2 Registry Settings	27
A.4	AIX Parameters	27
<i>Appendix - B</i>	<i>Database Build Scripts</i>	28
B.1	db2nodes.cfg	28
B.2	db2set_load.sh	28
B.3	/tpc/tpcd/tpcd/custom/bpvar.cfg	28
B.4	dbmcfg_load	28
B.5	dbcfg_load	28
B.6	create_nodegroups.ddl	28
B.7	create_bpools.ddl	28
B.8	create_tbspaces.ddl	28
B.9	createUfTables.ddl	29
B.10	deleteUfTables.ddl	29

B.11	create_tables.ddl	29
B.12	load.sh	30
B.13	load_lineitem.ddl	31
B.14	load_orders.ddl	31
B.15	load_partsupp.ddl	31
B.16	load_part.ddl	31
B.17	load_customer.ddl	31
B.18	load_supplier.ddl	31
B.19	create_index.ddl	31
B.20	runstats.ddl	32
B.21	db2set_run.sh	33
B.22	dbmcfg_run	33
B.23	dbcfg_run	33
B.24	tpcd.setup	33
B.25	buildtpcd	34
<i>Appendix - C Query Text and Output</i>		46
C.1	Qualification Query Output	46
C.2	First 10 rows of Test Database Tables	62
C.3	Query Substitution Parameters	65
<i>Appendix - D Driver Source Code</i>		69
D.1	tpcdbatch.h	69
D.2	tpcdbatch.sqc	70
D.3	tpcdUF.sqc	97
D.4	Makefile	103
D.5	runpower	103
D.6	runthroughput	106
D.7	ploaduf1	109
D.8	ploaduf2	109
D.9	ploaduf1.gruntO	110
D.10	ploaduf1.gruntL	110
<i>Appendix - E ACID Transaction Source Code</i>		111
E.1	acid.sqc	111
E.2	acid.h	121
E.3	Makefile	122
<i>Appendix - F Third Party Pricing</i>		123
F.1	CDW Pricing	123

Abstract

This report documents the full disclosure information required by the TPC Benchmark™ H Standard Specification Revision 2.1.0 dated August 14, 2003 for measurements on the IBM @server p5 570.

The software used includes AIX 5L V5.3 operating system with DB2 Universal Database V8.2.

Preface

TPC Benchmark™ H Standard Specification was developed by the Transaction Processing Performance Council (TPC). It was released on February 26, 1999, and most recently revised (Revision 2.1.0) on August 14, 2003. This is the full disclosure report for benchmark testing of the IBM @server p5 570 according to the TPC Benchmark™ H Standard Specification.

TPC Benchmark™ H is a Decision Support benchmark. It is a suite of business oriented queries and concurrent updates. The queries and the data populating the database have been chosen to have broad industry-wide relevance while maintaining a sufficient degree of ease of implementation. This benchmark illustrates Decision Support systems that:

- Examine large volumes of data;
- Execute queries with a high degree of complexity;
- Give answers to critical business questions.

TPC-H evaluates the performance of various decision support systems by the execution of sets of queries against a standard database under controlled conditions. The TPC-H queries:

- Give answers to real-world business questions;
- Simulate generated ad-hoc queries (e.g., via a point and click GUI interface);
- Are far more complex than most OLTP transactions;
- Include a rich breadth of operators and selectivity constraints;
- Generate intensive activity on the part of the database server component of the system under test;
- Are executed against a database complying to specific population and scaling requirements;
- Are implemented with constraints derived from staying closely synchronized with an on-line production database.

The TPC-H operations are modeled as follows:

- The database is continuously available 24 hours a day, 7 days a week, for ad-hoc queries from multiple end users and data modifications against all tables, except possibly during infrequent (e.g., once a month) maintenance sessions;
- The TPC-H database tracks, possibly with some delay, the state of the OLTP database through on-going refresh functions which batch together a number of modifications impacting some part of the decision support database;
- Due to the world-wide nature of the business data stored in the TPC-H database, the queries and the refresh functions may be executed against the database at any time, especially in relation to each other. In addition, this mix of queries and refresh functions is subject to specific ACIDity requirements, since queries and refresh functions may execute concurrently;
- To achieve the optimal compromise between performance and operational requirements, the database administrator can set, once and for all, the locking levels and the concurrent scheduling rules for queries and refresh functions.

The minimum database required to run the benchmark holds business data from 10,000 suppliers. It contains almost ten million rows representing a raw storage capacity of about 1 gigabyte. Compliant benchmark implementations may also use one of the larger permissible database populations (e.g., 100 gigabytes), as defined in Clause 4.1.3.

The performance metric reported by TPC-H is called the TPC-H Composite Query-per-Hour Performance Metric (QphH@Size), and reflects multiple aspects of the capability of the system to process queries. These aspects include the selected database size against which the queries are executed, the query processing power when queries are submitted by a single stream, and the query throughput when queries are submitted by multiple concurrent users. The TPC-H Price/Performance metric is expressed as \$/QphH@Size. To be compliant with the TPC-H standard, all references to TPC-H results for a given configuration must include all required reporting components (see Clause 5.4.6). The TPC believes that comparisons of TPC-H results measured against different database sizes are misleading and discourages such comparisons.

The TPC-H database must be implemented using a commercially available database management system (DBMS) and the queries executed via an interface using dynamic SQL. The specification provides for variants of SQL, as implementers are not required to have implemented a specific SQL standard in full.

TPC-H uses terminology and metrics that are similar to other benchmarks, originated by the TPC and others. Such similarity in terminology does not in any way imply that TPC-H results are comparable to other benchmarks. The only benchmark results comparable to TPC-H are other TPC-H results compliant with the same revision.

Despite the fact that this benchmark offers a rich environment representative of many decision support systems, this benchmark does not reflect the entire range of decision support requirements. In addition, the extent to which a customer can achieve the results reported by a vendor is highly dependent on how closely TPC-H approximates the customer application. The relative performance of systems derived from this benchmark does not necessarily hold for other workloads or environments. Extrapolations to any other environment are not recommended.

Benchmark results are highly dependent upon workload, specific application requirements, and systems design and implementation. Relative system performance will vary as a result of these and other factors. Therefore, TPC-H should not be used as a substitute for a specific customer application benchmarking when critical capacity planning and/or product evaluation decisions are contemplated.

Benchmark sponsors are permitted several possible system designs, provided that they adhere to the model described in Clause 6. A full disclosure report (FDR) of the implementation details, as specified in Clause 8, must be made available along with the reported results.

1.0 General Items

1.1. Benchmark Sponsor

A statement identifying the benchmark sponsor(s) and other participating companies must be provided

This benchmark was sponsored by International Business Machines Corporation.

1.2. Parameter Settings

Settings must be provided for all customer-tunable parameters and options which have been changed from the defaults found in actual products, including but not limited to:

- *Data Base tuning options;*
- *Optimizer/Query execution options;*
- *Query Processing tool/language configuration parameters;*
- *Recovery/commit options;*
- *Consistency/locking options;*
- *Operating system and configuration parameters;*
- *Configuration parameters and options for any other software component incorporated into the pricing structure;*
- *Compiler optimization options.*

Appendix A "Tunable Parameters" contains a list of all DB2 parameters and operating system parameters. Session initialization parameters can be set during or immediately after establishing the connection to the database within the tpcdbatch program documented in Appendix D "Driver Source Code". This result uses the default session initialization parameters established during preprocessing/binding of the tpcdbatch program.

1.3. Configuration Diagrams

Diagrams of both measured and priced configurations must be provided, accompanied by a description of the differences. This includes, but is not limited to:

- *Number and type of processors*
- *Size of allocated memory, and any specific mapping/partitioning of memory unique to the test and type of disk units (and controllers, if applicable)*
- *Number and type of disk units (and controllers, if applicable).*
- *Number of channels or bus connections to disk units, including the protocol type*
- *Number of LAN (e.g. Ethernet) connections, including routers, work stations, terminals, etc., that were physically used in the test or are incorporated into the pricing structure*
Type and run-time execution location of software components (e.g. DBMS, query processing tools/languages, middle-ware components, software drivers, etc.)

IBM @server p5 570 Benchmark Configuration

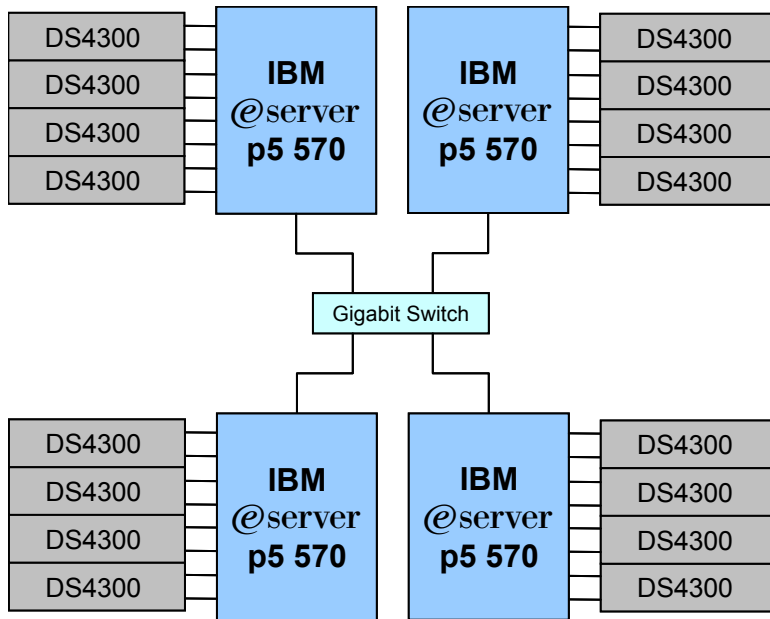

The system was a 4 node cluster of IBM @server p5 570 systems each with

- 4 POWER5 1900MHz processors with 2 x 36MB L3 cache
- 32 GB of memory
- 8 IBM 2Gb Fibre Channel PCI-X Adapters
- 2 73.4 GB 15K RPM Internal disk drives with 2 additional drives on node1
- 56 36.4 GB 15K RPM external disk drives
- 4 EXP700 disk enclosures
- 4 IBM TotalStorage DS4300 dual controllers
- 2 Integrated Gigabit Ethernet

For full details of the priced configuration, see the pricing spreadsheet in the Executive Summary.

2.0 Clause 1: Logical Database Design Related Items

Appendix B "Database Build Scripts" contains the programs and input files used to load the test database. The test and qualification databases use the same table definitions, indices and partitioning methods. Thus, the buildtpcd script documented in Appendix B was used for both the qualification and test databases except that different input files were used to define the tablespace devices and sizes.

2.1. Table Definitions

Listings must be provided for all table definition statements and all other statements used to set up the test and qualification databases.

Appendix B "Database Build Scripts" contains the table definitions and the programs to load the database.

2.2. Database Organization

The physical organization of tables and indices, within the test and qualification databases, must be disclosed. If the column ordering of any table is different from that specified in Clause 1.4, it must be noted.

Appendix B "Database Build Scripts" contains the DDL for the table and index definitions.

2.3. Horizontal Partitioning

Horizontal partitioning of tables and rows in the test and qualification databases (see Clause 1.5.4) must be disclosed.

Horizontal partitioning was used for all tables except for the nation and region tables, see Appendix B "Database Build Scripts".

2.4. Replication

Any replication of physical objects must be disclosed and must conform to the requirements of Clause 1.5.6.

No replication was used.

3.0 Clause 2: Queries and Refresh Functions

3.1. Query Language

The query language used to implement the queries must be identified (e.g., "RALF/SQL-Plus").

SQL was the query language used.

3.2. Verification for the Random Number Generator

The method of verification for the random number generation must be described unless the supplied DBGEN and QGEN were used.

The supplied QGEN version 2.1.1b and DBGEN 2.1.1b were used.

3.3. Substitution Parameters

3.3.1. Method of Generation

The method used to generate values for substitution parameters must be disclosed. If QGEN is not used for this purpose, then the source code of any non-commercial tool used must be disclosed. If QGEN is used, the version number, release number, modification number and patch level of QGEN must be disclosed.

The supplied QGEN version 2.1.1b was used to generate the substitution parameters.

3.4. Query Text

The executable query text used for query validation must be disclosed along with the corresponding output data generated during the execution of the query text against the qualification database. If minor modifications (see Clause 2.2.3) have been applied to any functional query definitions or approved variants in order to obtain executable query text, these modifications must be disclosed and justified. The justification for a particular minor query modification can apply collectively to all queries for which it has been used. The output data for the power and throughput tests must be made available electronically upon request.

Appendix C.1 "Qualification Query Output" contains the output for each of the queries.

Query variant Q15a was used in this disclosure.

The functional query definitions and variants used in this disclosure use the following minor query modifications.

1. Table names are fully qualified. For example, the nation table is referred to as "TPCD.NATION".
2. The standard IBM SQL date syntax is used for date arithmetic. For example: DATE('1996-01-01') + 3 MONTHS.
3. The semicolon ';' is used as a command delimiter.
4. Count_big was used instead of count in cases where aggregates exceed the range of values supported by an integer.

3.5. Query Substitution Parameters and Seeds

All query substitution parameters used for all performance tests must be disclosed in tabular format, along with the seeds used to generate these parameters.

Appendix C3, "Query Substitution Parameters" contains the query substitution parameters used in the performance tests.

3.6. Isolation Level

The isolation level used to run the queries must be disclosed. If the isolation level does not map closely to one of the isolation levels defined in Clause 3.4, additional descriptive detail must be provided.

The isolation level used to run the queries was repeatable read.

3.7. Refresh Functions

The details of how the refresh functions were implemented must be disclosed (including source code of any non-commercial program used).

The refresh functions are part of the implementation specific layer/driver code included in Appendix D "Driver Source Code".

4.0 Clause 3: Database System Properties

The results of the ACID tests must be disclosed along with a description of how the ACID requirements were met. This includes disclosing the code written to implement the ACID Transaction and Query.

All ACID tests were conducted according to specification. The Atomicity, Isolation, Consistency and Durability tests were performed on the @server p5 570. Appendix E. "Acid Transaction Source Code" contains the source code for the ACID transaction and query.

4.1. Atomicity Requirements

The system under test must guarantee that transactions are atomic; the system will either perform all individual operations on the data, or will assure that no partially-completed operations leave any effects on the data.

4.1.1. Atomicity of Completed Transaction

Perform the ACID transaction for a randomly selected set of input data and verify that the appropriate rows have been changed in the ORDER, LINEITEM, and HISTORY tables.

The following steps were performed to verify the atomicity of completed transactions:

1. The total price from the ORDER table and the extended price from the LINEITEM table were retrieved for a random Orderkey. The number of records in the HISTORY table was also retrieved.
2. The ACID transaction T1 was executed for the Orderkey used in Step 1.
3. The ACID transaction committed.
4. The total price and the extended price were retrieved for the same orderkey used in step 1 and step 2. It was verified that: $T1.EXTENDEDPRICE = OLD.EXTENDEDPRICE + ((T1.DELTA) * (OLD.EXTENDEDPRICE/OLD.QUANTITY))$, $T1.TOTALPRICE = OLD.TOTALPRICE + ((T1.EXTENDEDPRICE-OLD.EXTENDEDPRICE)*(1-DISCOUNT))*(1+TAX)$, and that the number of records in the history table had increased by 1.

4.1.2. Atomicity of Aborted Transactions

Perform the ACID transaction for a randomly selected set of input data, substituting a ROLLBACK of the transaction for the COMMIT of the transaction. Verify that the appropriate rows have not been changed in the ORDER, LINEITEM, and HISTORY tables.

The following steps were performed to verify the atomicity of the aborted ACID transaction:

1. The total price from the ORDER table and the extended price from the LINEITEM table were retrieved for a random Orderkey. The number of records in the HISTORY table was also retrieved.
2. The ACID transaction was executed for the Orderkey used in step 1.
3. The transaction was rolled back.
4. The total price and the extended price were retrieved for the same orderkey used in step 1 and step 2. It was verified that the extended price and the total price were the same as in step 1. The

number of records in the HISTORY table was retrieved again and verified to be the same as in step1.

4.2. Consistency Requirements

Consistency is the property of the application that requires any execution of transactions to take the database from one consistent state to another.

4.2.1. Consistency Condition

A consistent state for the TPC-H database is defined to exist when:

$$O_TOTALPRICE = SUM(L_EXTENDEDPRICE*(1-L_DISCOUNT)*(1+L_TAX))$$

for each ORDER and LINEITEM defined by (O_ORDERKEY=L_ORDERKEY)

The following queries were executed before and after a measurement to show that the database was always in a consistent state both initially and after a measurement.

```
SELECT DECIMAL(SUM(DECIMAL(INTEGER(INTEGER(DECIMAL
(INTEGER(100*DECIMAL(L_EXTENDEDPRICE,20,3)),20,3)*
(1-L_DISCOUNT)) * (1+L_TAX)),20,3)/100.0),20,3)
FROM TPCD.LINEITEM WHERE L_ORDERKEY = okey
SELECT DECIMAL(SUM(O_TOTALPRICE, 20, 3)) from TPCD.ORDERS WHERE
O_ORDERKEY = okey
```

4.2.2. Consistency Tests

Verify that the ORDER and LINEITEM tables are initially consistent as defined in Clause 3.3.2.1, based on a random sample of at least 10 distinct values of O_ORDERKEY.

The queries defined in 4.2.1 , "Consistency Condition" were run after initial database build and prior to executing the ACID transaction. The queries showed that the database is in a consistent state.

After executing 8 streams of 100 ACID transactions each, the queries defined in 4.2.1 , "Consistency Condition" were run again. The queries showed that the database was still in a consistent state.

4.3. Isolation Requirements

4.3.1. Isolation Test 1

This test demonstrates isolation for the read-write conflict of a read-write transaction and a read-only transaction when the read-write transaction is committed.

The following steps were performed to satisfy the test of isolation for a read-only and a read-write committed transaction:

1. 1st session: Start an ACID transaction with a randomly selected O_KEY,L_KEY and DELTA. The transaction is delayed for 60 seconds just prior to the Commit.
2. 2nd session: Start an ACID query for the same O_KEY as in the ACID transaction.

3. 2nd session: The ACID query attempts to read the file but is locked out by the ACID transaction waiting to complete.
4. 1st session: The ACID transaction is released and the Commit is executed releasing the record. With the LINEITEM record now released, the ACID query can now complete.
5. 2nd session: Verify that the ACID query delays for approximately 60 seconds and that the results displayed for the ACID query match the input for the ACID transaction.

4.3.2. Isolation Test 2

This test demonstrates isolation for the read-write conflict of read-write transaction and read-only transaction when the read-write transaction is rolled back.

The following steps were performed to satisfy the test of isolation for read-only and a rolled back read-write transaction:

1. 1st session: Perform the ACID transaction for a random O_KEY, L_KEY and DELTA. The transaction is delayed for 60 seconds just prior to the Rollback.
2. 2nd session: Start an ACID query for the same O_KEY as in the ACID transaction. The ACID query attempts to read the LINEITEM table but is locked out by the ACID transaction.
3. 1st session: The ACID transaction is released and the Rollback is executed, releasing the read.
4. 2nd session: With the LINEITEM record now released, the ACID query completes.

4.3.3. Isolation Test 3

This test demonstrates isolation for the write-write conflict of two refresh transactions when the first transaction is committed.

The following steps were performed to verify isolation of two refresh transactions:

1. 1st session: Start an ACID transaction T1 for a randomly selected O_KEY, L_KEY and DELTA. The transaction is delayed for 60 seconds just prior to the COMMIT.
2. 2nd session: Start a second ACID transaction T2 for the same O_KEY, L_KEY, and for a randomly selected DELTA2. This transaction is forced to wait while the 1st session holds a lock on the LINEITEM record requested by the second session.
3. 1st session: The ACID transaction T1 is released and the Commit is executed, releasing the record. With the LINEITEM record now released, the ACID transaction T2 can now complete.
4. Verify that:

$$T2.L_EXTENDEDPRICE = T1.L_EXTENDEDPRICE + (DELTA*(T1.L_EXTENDEDPRICE)/T1.L_QUANTITY)$$

4.3.4. Isolation Test 4

This test demonstrates isolation for write-write conflict of two ACID transactions when the first transaction is rolled back.

The following steps were performed to verify the isolation of two ACID transactions after the first one is rolled back:

1. 1st session: Start an ACID transaction T1 for a randomly selected O_KEY, L_KEY, and DELTA. The transaction is delayed for 60 seconds just prior to the rollback.
2. 2nd session: Start a second ACID transaction T2 for the same O_KEY, L_KEY used by the 1st session. This transaction is forced to wait while the 1st session holds a lock on the LINEITEM record requested by the second session.
3. 1st session: Rollback the ACID transaction T1. With the LINEITEM record now released, the ACID transaction T2 completes.
4. Verify that $T2.L_EXTENDEDPRICE = T1.L_EXTENDEDPRICE$

4.3.5. Isolation Test 5

This test demonstrates the ability of read and write transactions affecting different database tables to make progress concurrently.

1. 1st session: Start an ACID transaction, T1, for a randomly selected O_KEY, L_KEY and DELTA. The ACID transaction was suspended prior to COMMIT.
2. 2nd session: Start a second ACID transaction, T2, which selects random values of PS_PARTKEY and PS_SUPPKEY and returns all columns of the PARTSUPP table for which PS_PARTKEY and PS_SUPPKEY are equal to the selected values.
3. T2 completed.
4. T1 was allowed to complete.
5. It was verified that the appropriate rows in the ORDERS, LINEITEM and HISTORY tables have been changed.

4.3.6. Isolation Test 6

This test demonstrates that the continuous submission of arbitrary (read-only) queries against one or more tables of the database does not indefinitely delay refresh transactions affecting those tables from making progress.

1. 1st session: A transaction T1, which executes TPC-H query 1 with DELTA=0, was started.
2. 2nd session: Before T1 completed, an ACID transaction T2, with randomly selected values of O_KEY, L_KEY and DELTA, was started.
3. 3rd session: Before T1 completed, a transaction T3, which executes modified TPC-H query 1 with a randomly selected value of DELTA (not equal to 0), was started.
4. T1 completed.
5. T2 completed.
6. T3 completed.
7. It was verified that the appropriate rows in the ORDERS, LINEITEM and HISTORY tables were changed.

4.4. Durability Requirements

The SUT must guarantee durability: the ability to preserve the effects of committed transactions and ensure database consistency after recovery from any one of the failures listed in Clause 3.5.3.

4.4.1. Permanent Failure of Single Durable Medium and Loss of System Power

These tests were combined and conducted on the qualification database. The following steps were performed:

1. The consistency test described in section 4.2.1 was verified.
2. The current count of the total number of records in the HISTORY table was determined giving hist1.
3. A test to run 200 ACID transactions on each of 10 execution streams was started such that each stream executes a different set of transactions.
4. One of the disks containing the DB2 transaction log recovery data, database table data, database index and temporary space was removed from the enclosure after at least 20 ACID transactions had completed from each of the execution streams.
5. Because the disks were in RAID 5 configuration the applications continued running the ACID transactions.
6. The system was shutdown by switching off the power for all system components, after at least a total of 100 transactions had completed for each stream.
7. The system was powered back on and rebooted, and the database was restarted.
8. Step 2 was performed giving hist2. It was verified that hist2 - hist1 was greater than or equal to the number of records in the success file.
9. Consistency condition described in 4.2.1 was verified.

4.4.2. Loss of Switch Power

This test was conducted on the qualification database. The following steps were performed:

1. The consistency test described in section 4.2.1 was verified.
2. The current count of the total number of records in the HISTORY table was determined giving hist1.
3. A test to run 200 ACID transactions on each of 10 execution streams was started such that each stream executes a different set of transactions.
4. The Gigabit switch was disconnected from the system.
5. Database detected the network loss and terminated processing
6. Network connections were reestablished and the database was restarted
7. Step 2 was performed giving hist2. It was verified that hist2 - hist1 was greater than or equal to the number of records in the success file.
8. Consistency condition described in 4.2.1 was verified.

4.4.3. Failure of Storage Controller, and Loss of System Power

This test was conducted on the qualification database. The following steps were performed:

1. The consistency test described in section 4.2.1 was verified.
2. The current count of the total number of records in the HISTORY table was determined giving hist1.
3. A test to run 200 ACID transactions on each of 10 execution streams was started such that each stream executes a different set of transactions.
4. A controller which was on the preferred path of database log data, database table data, database index and temporary space was removed after at least 20 ACID transactions had completed from each of the execution streams.
5. The storage system automatically switched the disks to the backup disk controller. The applications continued running the ACID transactions.
6. The system was shutdown by switching off the power for all system components, after at least a total of 100 transactions had completed for each stream.
7. The system was powered back on and rebooted, and the database was restarted.
8. Step 2 was performed giving hist2. It was verified that hist2 - hist1 was greater than or equal to the number of records in the success file.
9. Consistency condition described in 4.2.1 was verified.

5.0 Clause 4: Scaling and Database Population Related Items

5.1. Cardinality of Tables

The cardinality (e.g., the number of rows) of each table of the test database, as it existed at the completion of the database load (see Clause 4.2.5), must be disclosed.

The following table contains the TPC Benchmark™ H defined tables and the number of rows for each table as they existed upon build completion:

Table	Rows
Lineitem	5,999,989,709
Orders	1,500,000,000
Customer	150,000,000
Supplier	10,000,000
Part	200,000,000
Partsupp	800,000,000
Nation	25
Region	5

5.2. Distribution of Tables and Logs

The distribution of tables and logs across all media must be explicitly depicted for the tested and priced systems.

DB2 was configured on a four node cluster of IBM @server p5 570 servers. Each node had:

- 8 IBM 2Gb Fibre Channel PCI-X adapters
- 56 36.4GB external disk drives.
- Node 1 had 4 73.4GB internal drives and nodes 2, 3 and 4 each had 2 73.4GB drives

Each IBM @server p5 570 had four IBM TotalStorage DS4300 dual controllers. Each of the two controllers in each DS43000 had two 2+p RAID 5 arrays and one non RAID disk. Each of the controllers was accessed through one FC adapter.

Permanent tables, their auxiliary data structures, and database logs resided in tablespaces created on the RAID 5 arrays. Temporary tables resided in tablespaces created across all disks, and were not fully RAID protected. See Appendix B "Database Build Scripts".

The Operating System resided on an internal disk on each node. The database software resided on an internal disk on each node. Two additional disks on node 1 were used for the benchmark executable programs and results. This filesystem was NFS mounted by node 2, 3 and 4 from node 1.

5.3. Mapping of Database Partitions/Replications

The mapping of database partitions/replications must be explicitly described.

The database was not replicated. The database was logically partitioned into 32 logical data partitions, 8 data partitions on each physical server.

5.4. Implementation of RAID

Implementations may use some form of RAID to ensure high availability. If used for data, auxiliary storage (e.g. indexes) or temporary space the level of RAID used must be disclosed for each device.

RAID level 5 was used for database tables, indexes, and recovery logs.

5.5. DBGEN Modifications

The version number, release number, modification number, and patch level of DBGEN must be disclosed. Any modifications to the DBGEN (see Clause 4.2.1) source code must be disclosed. In the event that a program other than DBGEN was used to populate the database, it must be disclosed in its entirety.

The standard distribution of DBGEN version 2.1.1b was used.

5.6. Database Loading

The database load time for the test database (see Clause 4.3) must be disclosed.

The database load time was 2:32:13.

5.7. Data Storage Ratio

The data storage ratio must be disclosed. It is computed by dividing the total data storage of the priced configuration (expressed in GB) by the size chosen for the test database as defined in clause 4.1.3.1. The ratio must be reported to the nearest 1/100th, rounded up.

The calculation of the data storage ratio is shown in the following table:

Disk Type	Number of Disks	Space per Disk	Sub-Total Disk Space	Database Size	Data Storage Ratio
ULTRA4 73.4GB	10	68.359 GB	683.59 GB		
2GB FC 36.4GB	224	33.900 GB	7,593.60 GB		
Total			8,277.19 GB	1,000 GB	8.28

5.8. Details of Database Loading

The details of the database load must be disclosed, including a block diagram illustrating the overall process. Disclosure of the load procedure include all steps, scripts, input and configuration files required to completely reproduce the test and qualification databases.

Flat files for each of the tables were created using DBGEN. Appendix B "Database Build Scripts" contains the programs and input files used to load the database.

Database Load Procedure:

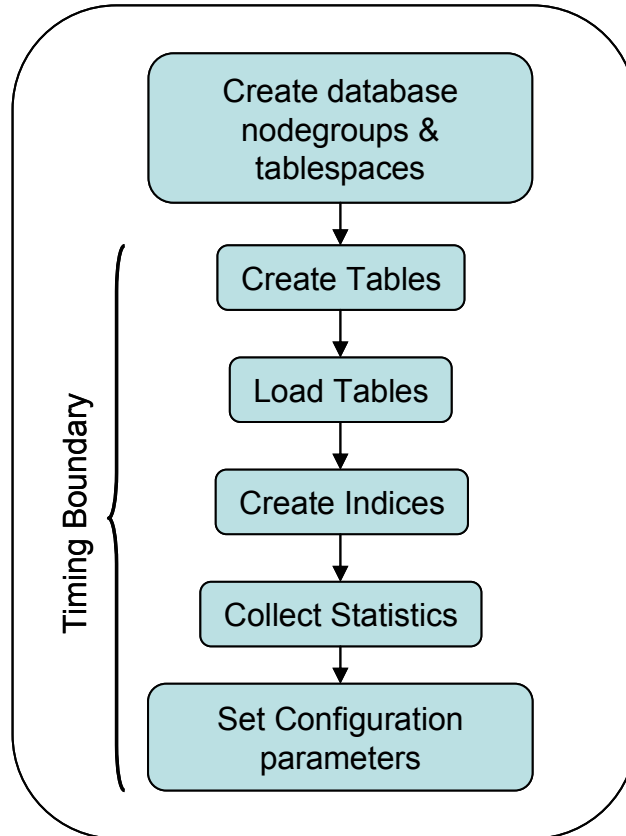

6.0 Clause 5: Performance Metrics and Execution-Rules Related Items

6.1. System Activity Between Load and Performance Tests

Any system activity on the SUT that takes place between the conclusion of the load test and the beginning of the performance test must be fully disclosed

Auditor requested queries were run against the database to verify correctness of the database load.

6.2. Steps in the Power Test

The details of the steps followed to implement the power test (e.g., system boot, database restart, etc.) must be disclosed.

The following steps were used to implement the power test:

1. RF1 Refresh Transaction
2. Stream 00 Execution
3. RF2 Refresh Transaction

6.3. Timing Intervals for Each Query and Refresh Function

The timing intervals for each query of the measured set and for both refresh functions must be reported for the power test.

See Numerical Quantities Summary in the Executive Summary.

6.4. Number of Streams for the Throughput Test

The number of execution streams used for the throughput test must be disclosed.

See Numerical Quantities Summary in the Executive Summary.

6.5. Start and End Date/Times for Each Query Stream

The start time and finish time for each query execution stream must be reported for the throughput test.

See Numerical Quantities Summary in the Executive Summary.

6.6. Total Elapsed Time for the Measurement Interval

The total elapsed time of the measurement interval (see Clause 5.3.6) must be reported for the throughput test.

See Numerical Quantities Summary in the Executive Summary.

6.7. Refresh Function Start Date/Time and Finish Date/Time

Start and finish time for each refresh function in the refresh stream must be reported for the throughput test.

See Numerical Quantities Summary in the Executive Summary.

6.8. Timing Intervals for Each Query and Each Refresh Function for Each Stream

The timing intervals (see Clause 5.3.7) for each query of each stream and for each refresh function must be reported for the throughput test.

See Numerical Quantities Summary in the Executive Summary.

6.9. Performance Metrics

The computed performance metric, related numerical quantities and price performance metric must be reported.

See Numerical Quantities Summary in the Executive Summary.

6.10. The Performance Metric and Numerical Quantities from Both Runs

The performance metric and numerical quantities from both runs must be disclosed.

Performance results from the first two executions of the TPC-H benchmark indicated the following percent difference for the metric points:

	QppH@1000GB	QthH@1000GB	QphH@1000GB
Run 1	35,789.6	19,115.9	26,156.3
Run 2	36,214.6	19,194.7	26,365.3

6.11. System Activity Between Tests

Any activity on the SUT that takes place between the conclusion of Run1 and the beginning of Run2 must be disclosed.

The database server was restarted between runs.

7.0 Clause 6: SUT and Driver Implementation

7.1. Driver

A detailed textual description of how the driver performs its functions must be supplied, including any related source code or scripts. This description should allow an independent reconstruction of the driver.

Appendix D "Driver Source Code" contains the source code used for the driver and all scripts used in connection with it.

The power test is invoked by calling `tpcdbatch` with the stream number 0 specified. The refresh function is initiated as a separate call to `tpcdbatch` with the SQL script for the refresh functions.

The Throughput test is invoked by initiating a call to `tpcdbatch` for every query stream that will be run. `tpcdbatch` gets the stream number for each of the streams, and the SQL file specific to that stream number as the queries to execute. The refresh function is initiated as a separate call to `tpcdbatch` with the SQL script for the refresh functions and the total number of query streams specified.

7.2. Implementation Specific Layer

If an implementation specific layer is used, then a detailed description of how it performs its functions must be supplied, including any related source code or scripts. This description should allow an independent reconstruction of the implementation specific layer.

The implementation specific layer is a single executable SQL application that uses embedded dynamic SQL to process the EQT generated by QGEN. The application is called `tpcdbatch` to indicate that it processes a batch of TPC-H queries, although it is completely capable of processing any arbitrary SQL statement (both DML and DDL).

A separate instance of `tpcdbatch` is invoked for each stream. Each instance establishes a distinct connection to the database server through which the EQT is transmitted to the database and the results are returned through the implementation specific layer to the driver. When an instance of `tpcdbatch` is invoked, it is provided with a context of whether it is running a power test, query stream or refresh stream, as well as an input file containing the 22 queries and/or refresh functions. `tpcdbatch` then connects to the database, performs any session initialization as well as preparing output files required by the auditor. Then it proceeds to read from the input file and processes each query or refresh function in turn.

For queries, each query is prepared, described, and a cursor is opened and used to fetch the required number of rows. After the last row has been retrieved a commit is issued. For the refresh functions, during the database build all data is first split for each node using the `db2split` utility. For RF1, the data for each node is further split into n equal portions for both the `lineitem` and `orders` tables taking care that the records for the same orderkey remain in the same set. For RF2, the data for each node is further split into m equal portions. During the run, when `tpcdbatch` encounters a call to execute RF1, it first calls a shell script which loads these n sets of data into staging tables. Then `tpcdbatch` forks off q children (where $q * y = n$), with each child to do y sets of insert with `fullselect` from the staging tables into the original `lineitem` and `orders` tables. When `tpcdbatch` encounters a call to execute RF2, it calls a shell script that loads these data into a single staging table. Then `tpcdbatch` forks off p children (where $p * x = m$) to do x sets of deletes from the `orders` and `lineitem` tables with a `subselect` from the staging table.

7.3. Profile-Directed Optimization

If profile-directed optimization as described in Clause 5.2.9 is used, such used must be disclosed.

Profile-directed optimization was not used.

8.0 Clause 7: Pricing-Related Items

8.1. Hardware and Software Used

A detailed list of hardware and software used in the priced system must be reported. Each item must have a vendor part number, description, and release/revision level, and indicate General Availability (see Clause 7.2.2.1) either implicitly or explicitly (omitted Availability Dates default to the System Availability Date). If package pricing is used, contents of the package must be disclosed. Pricing source(s) and effective date(s) of price(s) must also be reported.

The detailed list of all hardware and software for the priced configuration is listed in the Executive Summary.

8.2. Three Year Cost of System Configuration

The total 3-year price of the entire configuration must be reported, including: hardware, software, hardware maintenance, and software support charges. Separate component pricing is required (see Clause 7.3.1. Pricing Spreadsheet.) Hardware maintenance and software support must be reported separately. The software support level must be disclosed separately from that of hardware, with separate pricing and discounts.

The price sheet for this disclosure is contained in the executive summary pages.

The pricing spreadsheet includes maintenance costs for 3 years. This service provides 7 days per week, 24 hours per day coverage.

Discounts are based on US list prices and for similar quantities and configurations. A discount of 28% has been applied to all IBM hardware, software, and services based on the total value and quantities of the components of the configuration, including full payment of all components and maintenance.

The prices listed for the IBM software products includes software support that provides the items identified in paragraph 7.1.5.6 of the TPC-H Benchmark Specification.

For assistance with any of these prices or their applicability to any customer's requirements, please contact one of the following individuals:

Bill Casey, @server pSeries Offering Manager

email: wrcasey@us.ibm.com phone 1-512-838-1422

Paul Rivot, Director Database Servers and Business Intelligence Software

email: privot@us.ibm.com phone 1-914-766-1325

8.3. System Availability Date

The System Availability Date (see Clause 7.2.2.1) must be the single availability date reported on the first page of the executive summary. The full disclosure report must report Availability Dates individually for at least each of the categories for which a pricing subtotal must be provided (see Clause 7.3.1.4). All Availability Dates required to be reported must be disclosed to a precision of 1 day, but the precise format is left to the test sponsor.

The System Availability Date is December 15, 2004. All hardware (server and storage) components are available immediately. Operating system software is available immediately. Database software is available December 15, 2004.

9.0 Clause 9: Audit Items

The auditor's agency name, address, phone number, and Attestation letter with a brief audit summary report indicating compliance must be included in the full disclosure report. A statement should be included specifying who to contact in order to obtain further information regarding the audit process.

The auditor's attestation letter is included at the front of this report.

Appendix - A Tunable Parameters

A.1 DB2 Database Configuration

get database configuration for TPCD

Database Configuration for Database TPCD

Database configuration release level = 0x0a00
Database release level = 0x0a00

Database territory = US
Database code page = 819
Database code set = ISO8859-1
Database country/region code = 1
Database collating sequence = BINARY
Alternate collating sequence (ALT_COLLATE) =

Dynamic SQL Query management (DYN_QUERY_MGMT) = DISABLE

Discovery support for this database (DISCOVER_DB) = ENABLE

Default query optimization class (DFT_QUERYOPT) = 7
Degree of parallelism (DFT_DEGREE) = 1
Continue upon arithmetic exceptions (DFT_SQLMATHWARN) = NO
Default refresh age (DFT_REFRESH_AGE) = 0
Default maintained table types for opt (DFT_MTTB_TYPES) = SYSTEM
Number of frequent values retained (NUM_FREQVALUES) = 0
Number of quantiles retained (NUM_QUANTILES) = 600

Backup pending = NO

Database is consistent = YES
Rollforward pending = NO
Restore pending = NO

Multi-page file allocation enabled = YES

Log retain for recovery status = NO
User exit for logging status = NO

Data Links Token Expiry Interval (sec) (DL_EXPINT) = 60
Data Links Write Token Init Expiry Intvl(DL_WT_IEXPINT) = 60
Data Links Number of Copies (DL_NUM_COPIES) = 1
Data Links Time after Drop (days) (DL_TIME_DROP) = 1
Data Links Token in Uppercase (DL_UPPER) = NO
Data Links Token Algorithm (DL_TOKEN) = MAC0

Database heap (4KB) (DBHEAP) = 7500
Size of database shared memory (4KB) (DATABASE_MEMORY) = 654556
Catalog cache size (4KB) (CATALOGCACHE_SZ) = (MAXAPPLS*4)
Log buffer size (4KB) (LOGBUFSZ) = 1024
Utilities heap size (4KB) (UTIL_HEAP_SZ) = 5000
Buffer pool size (pages) (BUFFPAGE) = 1000
Extended storage segments size (4KB) (ESTORE_SEG_SZ) = 16000
Number of extended storage segments (NUM_ESTORE_SEGS) = 0
Max storage for lock list (4KB) (LOCKLIST) = 8196

Max size of appl. group mem set (4KB) (APPGROUP_MEM_SZ) = 40000
Percent of mem for appl. group heap (GROUPHEAP_RATIO) = 70
Max appl. control heap size (4KB) (APP_CTL_HEAP_SZ) = 512

Sort heap thres for shared sorts (4KB) (SHEAPTHRES_SHR) = 250
Sort list heap (4KB) (SORTHEAP) = 20000
SQL statement heap (4KB) (STMTHEAP) = 20000
Default application heap (4KB) (APPLHEAPSZ) = 156
Package cache size (4KB) (PCKCACHESZ) = (MAXAPPLS*8)
Statistics heap size (4KB) (STAT_HEAP_SZ) = 4384

Interval for checking deadlock (ms) (DLCHKTIME) = 10000
Percent. of lock lists per application (MAXLOCKS) = 13
Lock timeout (sec) (LOCKTIMEOUT) = -1

Changed pages threshold (CHNGPGS_THRESH) = 70
Number of asynchronous page cleaners (NUM_IOCLEANERS) = 1
Number of I/O servers (NUM_IOSERVERS) = 2
Index sort flag (INDEXSORT) = YES
Sequential detect flag (SEQDETECT) = YES
Default prefetch size (pages) (DFT_PREFETCH_SZ) = AUTOMATIC

Track modified pages (TRACKMOD) = OFF

Default number of containers = 1
Default tablespace extentsize (pages) (DFT_EXTENT_SZ) = 32

Max number of active applications (MAXAPPLS) = 365
Average number of active applications (AVG_APPLS) = 1
Max DB files open per application (MAXFILOP) = 1024

Log file size (4KB) (LOGFILSIZ) = 8192
Number of primary log files (LOGPRIMARY) = 50
Number of secondary log files (LOGSECOND) = 5
Changed path to log files (NEWLOGPATH) =
Path to log files = /db/tpcd/NODE0001/
Overflow log path (OVERFLOWLOGPATH) =
Mirror log path (MIRRORLOGPATH) =
First active log file =
Block log on disk full (BLK_LOG_DSK_FUL) = NO
Percent of max active log space by transaction(MAX_LOG) = 0
Num. of active log files for 1 active UOW(NUM_LOG_SPAN) = 0

Group commit count (MINCOMMIT) = 1
Percent log file reclaimed before soft chckpt (SOFTMAX) = 300
Log retain for recovery enabled (LOGRETAIN) = OFF
User exit for logging enabled (USEREXIT) = OFF

HADR database role = STANDARD
HADR local host name (HADR_LOCAL_HOST) =
HADR local service name (HADR_LOCAL_SVC) =
HADR remote host name (HADR_REMOTE_HOST) =
HADR remote service name (HADR_REMOTE_SVC) =
HADR instance name of remote server (HADR_REMOTE_INST) =
HADR timeout value (HADR_TIMEOUT) = 120
HADR log write synchronization mode (HADR_SYNCMODE) = NEARSYNC

First log archive method (LOGARCHMETH1) = OFF
Options for logarchmeth1 (LOGARCHOPT1) =
Second log archive method (LOGARCHMETH2) = OFF
Options for logarchmeth2 (LOGARCHOPT2) =
Failover log archive path (FAILARCHPATH) =
Number of log archive retries on error (NUMARCHRETRY) = 5
Log archive retry Delay (secs) (ARCHRETRYDELAY) = 20
Vendor options (VENDOROPT) =

Auto restart enabled (AUTORESTART) = ON
Index re-creation time and redo index build (INDEXREC) = SYSTEM (RESTART)
Log pages during index build (LOGINDEXBUILD) = OFF
Default number of loadrec sessions (DFT_LOADREC_SES) = 1

Number of database backups to retain (NUM_DB_BACKUPS) = 12
Recovery history retention (days) (REC_HIS_RETENTN) = 366

TSM management class (TSM_MGMTCLASS) =
TSM node name (TSM_NODENAME) =
TSM owner (TSM_OWNER) =
TSM password (TSM_PASSWORD) =

Automatic maintenance (AUTO_MAINT) = OFF
Automatic database backup (AUTO_DB_BACKUP) = OFF
Automatic table maintenance (AUTO_TBL_MAINT) = OFF
Automatic runstats (AUTO_RUNSTATS) = OFF
Automatic statistics profiling (AUTO_STATS_PROF) = OFF
Automatic profile updates (AUTO_PROF_UPD) = OFF
Automatic reorganization (AUTO_REORG) = OFF

A.2 DB2 Database Manager Configuration

get database manager configuration

Database Manager Configuration

Node type = Enterprise Server Edition with local and remote clients

Database manager configuration release level = 0x0a00

CPU speed (millisec/instruction) (CPUSPEED) = 4.978755e-07

Communications bandwidth (MB/sec) (COMM_BANDWIDTH) = 2.000000e+02

Max number of concurrently active databases (NUMDB) = 1
Data Links support (DATALINKS) = NO
Federated Database System Support (FEDERATED) = NO
Transaction processor monitor name (TP_MON_NAME) =

Default charge-back account (DFT_ACCOUNT_STR) =

Java Development Kit installation path (JDK_PATH) =
/usr/java14_64

Diagnostic error capture level (DIAGLEVEL) = 3
Notify Level (NOTIFYLEVEL) = 3
Diagnostic data directory path (DIAGPATH) =
/db2dump/db2dump

Default database monitor switches

Buffer pool (DFT_MON_BUFPOOL) = OFF
Lock (DFT_MON_LOCK) = OFF
Sort (DFT_MON_SORT) = OFF
Statement (DFT_MON_STMT) = OFF
Table (DFT_MON_TABLE) = OFF
Timestamp (DFT_MON_TIMESTAMP) = ON
Unit of work (DFT_MON_UOW) = OFF
Monitor health of instance and databases (HEALTH_MON) = OFF

SYSADM group name (SYSADM_GROUP) =
SYSCTRL group name (SYSCTRL_GROUP) =
SYSMAINT group name (SYSMAINT_GROUP) =
SYSMON group name (SYSMON_GROUP) =

Client Userid-Password Plugin (CLNT_PW_PLUGIN) =
Client Kerberos Plugin (CLNT_KRB_PLUGIN) =
Group Plugin (GROUP_PLUGIN) =
GSS Plugin for Local Authorization (LOCAL_GSSPLUGIN) =
Server Plugin Mode (SRV_PLUGIN_MODE) =
UNFENCED

Server List of GSS Plugins (SRVCON_GSSPLUGIN_LIST) =
Server Userid-Password Plugin (SRVCON_PW_PLUGIN) =
Server Connection Authentication (SRVCON_AUTH) =
NOT_SPECIFIED
Database manager authentication (AUTHENTICATION) =
SERVER
Cataloging allowed without authority (CATALOG_NOAUTH) = NO
Trust all clients (TRUST_ALLCLNTS) = YES
Trusted client authentication (TRUST_CLNTAUTH) = CLIENT
Bypass federated authentication (FED_NOAUTH) = NO

Default database path (DFTDBPATH) = /tpc/tpcd

Database monitor heap size (4KB) (MON_HEAP_SZ) = 90
Java Virtual Machine heap size (4KB) (JAVA_HEAP_SZ) = 1024
Audit buffer size (4KB) (AUDIT_BUF_SZ) = 0
Size of instance shared memory (4KB) (INSTANCE_MEMORY) =
AUTOMATIC
Backup buffer default size (4KB) (BACKBUFSZ) = 1024
Restore buffer default size (4KB) (RESTBUFSZ) = 1024

Sort heap threshold (4KB) (SHEAPTHRES) = 2800000

Directory cache support (DIR_CACHE) = YES

Application support layer heap size (4KB) (ASLHEAPSZ) = 15
Max requester I/O block size (bytes) (RQRIOBLK) = 32767
Query heap size (4KB) (QUERY_HEAP_SZ) = 1000

Workload impact by throttled utilities(UTIL_IMPACT_LIM) = 10

Priority of agents (AGENTPRI) = SYSTEM
Max number of existing agents (MAXAGENTS) = 400
Agent pool size (NUM_POOLAGENTS) =
200(calculated)
Initial number of agents in pool (NUM_INITAGENTS) = 30
Max number of coordinating agents (MAX_COORDAGENTS) =
(MAXAGENTS - NUM_INITAGENTS)
Max no. of concurrent coordinating agents (MAXCAGENTS) =
MAX_COORDAGENTS
Max number of client connections (MAX_CONNECTIONS) =
MAX_COORDAGENTS

Keep fenced process (KEEPFENCED) = YES
Number of pooled fenced processes (FENCED_POOL) =
MAX_COORDAGENTS
Initial number of fenced processes (NUM_INITFENCED) = 0

Index re-creation time and redo index build (INDEXREC) = RESTART

Transaction manager database name (TM_DATABASE) =
1ST_CONN
Transaction resync interval (sec) (RESYNC_INTERVAL) = 180

SPM name (SPM_NAME) =
SPM log size (SPM_LOG_FILE_SZ) = 256
SPM resync agent limit (SPM_MAX_RESYNC) = 20
SPM log path (SPM_LOG_PATH) =

TCP/IP Service name (SVCENAME) =
Discovery mode (DISCOVER) = SEARCH
Discover server instance (DISCOVER_INST) = ENABLE

Maximum query degree of parallelism (MAX_QUERYDEGREE) =
ANY
Enable intra-partition parallelism (INTRA_PARALLEL) = NO

No. of int. communication buffers(4KB)(FCM_NUM_BUFFERS) =
262144

Number of FCM request blocks (FCM_NUM_RQB) =
AUTOMATIC
Number of FCM connection entries (FCM_NUM_CONNECT) =
AUTOMATIC
Number of FCM message anchors (FCM_NUM_ANCHORS) =
AUTOMATIC

Node connection elapse time (sec) (CONN_ELAPSE) = 10
Max number of node connection retries (MAX_CONNRETRIES) = 5
Max time difference between nodes (min) (MAX_TIME_DIFF) = 60

db2start/db2stop timeout (min) (START_STOP_TIME) = 10

A.3 DB2 Registry Settings

DB2_LARGE_PAGE_MEM=DB
DB2_EXTENDED_OPTIMIZATION=Y
DB2_ANTIJOIN=ON
DB2BPVARS=/tpc/tpcd/tpcd/custom/bpvars.cfg
DB2_FORCE_FCM_BP=ON
DB2OPTIONS=-t -v +c
DB2_PARALLEL_IO=*

/tpc/tpcd/tpcd/custom/bpvars.cfg Content
NUMPREFETCHQUEUES=1
PREFETCHQUEUESIZE=100

A.4 AIX Parameters

vmo -r -o minperm%=15
vmo -r -o maxperm%=25
vmo -r -o maxclient%=15
vmo -r -o maxfree=184
vmo -r -o v_pinshm=1
vmo -r -o lgpg_size=16M
vmo -r -o lgpg_regions=1152

ioo -r -o lvm_bufcnt=16
ioo -r -o maxpgahead=64

chdev -l sys0 -a maxuproc=8000

chuser capabilities=CAP_BYPASS_RAC_VMM,CAP_PROPAGATE
,CAP_NUMA_ATTACH tpcd

node1:
DB2/MLN1:
owner = tpcd
group = system
perm = rwr-r-
resources = sys/cpu.00000

DB2/MLN2:
owner = tpcd
group = system
perm = rwr-r-
resources = sys/cpu.00001

DB2/MLN3:
owner = tpcd
group = system
perm = rwr-r-
resources = sys/cpu.00002

DB2/MLN4:
owner = tpcd
group = system
perm = rwr-r-
resources = sys/cpu.00003

node2:
DB2/MLN5:
owner = tpcd

group = system
perm = rwr-r-
resources = sys/cpu.00000

DB2/MLN6:
owner = tpcd
group = system
perm = rwr-r-
resources = sys/cpu.00001

DB2/MLN7:
owner = tpcd
group = system
perm = rwr-r-
resources = sys/cpu.00002

DB2/MLN8:
owner = tpcd
group = system
perm = rwr-r-
resources = sys/cpu.00003

node3:
DB2/MLN9:
owner = tpcd
group = system
perm = rwr-r-
resources = sys/cpu.00000

DB2/MLN10:
owner = tpcd
group = system
perm = rwr-r-
resources = sys/cpu.00001

DB2/MLN11:
owner = tpcd
group = system
perm = rwr-r-
resources = sys/cpu.00002

DB2/MLN12:
owner = tpcd
group = system
perm = rwr-r-
resources = sys/cpu.00003

node4:
DB2/MLN13:
owner = tpcd
group = system
perm = rwr-r-
resources = sys/cpu.00000

DB2/MLN14:
owner = tpcd
group = system
perm = rwr-r-
resources = sys/cpu.00001

DB2/MLN15:
owner = tpcd
group = system
perm = rwr-r-
resources = sys/cpu.00002

DB2/MLN16:
owner = tpcd
group = system
perm = rwr-r-
resources = sys/cpu.00003

Appendix - B Database Build Scripts

B.1 db2nodes.cfg

```
1 c614f1g01 0 c614f1g01 DB2/MLN1
2 c614f1g01 1 c614f1g01 DB2/MLN2
3 c614f1g01 2 c614f1g01 DB2/MLN3
4 c614f1g01 3 c614f1g01 DB2/MLN4
5 c614f1g01 4 c614f1g01 DB2/MLN1
6 c614f1g01 5 c614f1g01 DB2/MLN2
7 c614f1g01 6 c614f1g01 DB2/MLN3
8 c614f1g01 7 c614f1g01 DB2/MLN4
9 c614f1g02 0 c614f1g02 DB2/MLN5
10 c614f1g02 1 c614f1g02 DB2/MLN6
11 c614f1g02 2 c614f1g02 DB2/MLN7
12 c614f1g02 3 c614f1g02 DB2/MLN8
13 c614f1g02 4 c614f1g02 DB2/MLN5
14 c614f1g02 5 c614f1g02 DB2/MLN6
15 c614f1g02 6 c614f1g02 DB2/MLN7
16 c614f1g02 7 c614f1g02 DB2/MLN8
17 c614f2g01 0 c614f2g01 DB2/MLN9
18 c614f2g01 1 c614f2g01 DB2/MLN10
19 c614f2g01 2 c614f2g01 DB2/MLN11
20 c614f2g01 3 c614f2g01 DB2/MLN12
21 c614f2g01 4 c614f2g01 DB2/MLN9
22 c614f2g01 5 c614f2g01 DB2/MLN10
23 c614f2g01 6 c614f2g01 DB2/MLN11
24 c614f2g01 7 c614f2g01 DB2/MLN12
25 c614f2g02 0 c614f2g02 DB2/MLN13
26 c614f2g02 1 c614f2g02 DB2/MLN14
27 c614f2g02 2 c614f2g02 DB2/MLN15
28 c614f2g02 3 c614f2g02 DB2/MLN16
29 c614f2g02 4 c614f2g02 DB2/MLN13
30 c614f2g02 5 c614f2g02 DB2/MLN14
31 c614f2g02 6 c614f2g02 DB2/MLN15
32 c614f2g02 7 c614f2g02 DB2/MLN16
```

B.2 db2set_load.sh

```
#!/bin/ksh
db2set DB2OPTIONS="-t -v +c"
db2set DB2_EXTENDED_OPTIMIZATION=Y
db2set DB2_ANTIJOIN=ON
db2set DB2_FORCE_FCM_BP=ON
db2set DB2BPVARS=/tpc/tpcd/tpcd/custom/bpvars.cfg
db2set DB2_PARALLEL_IO=""
db2set DB2_LARGE_PAGE_MEM=DB
```

B.3 /tpc/tpcd/tpcd/custom/bpvar.cfg

```
NUMPREFETCHQUEUES=1
PREFETCHQUEUESIZE=100
```

B.4 dbmcfg_load

```
update database manager configuration using
comm_bandwidth 200
numdb 1
diagpath /db2dump/db2dump
cpuspeed 4.978755e-07
sheapthres 2800000
max_querydegree -1
FCM_NUM_BUFFERS 16384
HEALTH_MON off
intra_parallel no;
```

get database manager configuration;

B.5 dbcfg_load

```
update database configuration for tpcd using
dft_queryopt 7
num_freqvalues 0
num_quantiles 600
stat_heap_sz 20000
dbheap 1500
newlogpath /db/tpcd
logbufsz 1024
util_heap_sz 65536
locklist 4096
app_ctl_heap_sz 512
sortheap 30000
stmtheap 10000
applheapsz 156
maxlocks 13
chngpgs_thresh 90
num_iocleaners 1
num_ioservers 2
maxappls 365
maxfilop 1024
logfilsiz 8192
logprimary 50
SHEAPTHRES_SHR 250
logsecond 5;
```

B.6 create_nodegroups.ddl

```
CREATE NODEGROUP ng_all ON NODES (1 to 32);
CREATE NODEGROUP ng_node1 ON NODE (1);
COMMIT WORK;
```

B.7 create_b pools.ddl

```
ALTER BUFFERPOOL IBMDEFAULTBP SIZE 24576;
COMMIT WORK;
CREATE BUFFERPOOL BPTM32K ALL NODES SIZE 8192
PAGESIZE 32K;
COMMIT WORK;
CREATE BUFFERPOOL BP32K ALL NODES SIZE 59392 PAGESIZE
32K;
COMMIT WORK;
```

B.8 create_tbspaces.ddl

```
CREATE regular TABLESPACE TABDATA
in nodegroup ng_all
PAGESIZE 32K MANAGED BY DATABASE
USING (
device '/dev/rdata1p $N' 694272,
device '/dev/rdata2p $N' 694272
)
BUFFERPOOL BP32K
extentsize 16
prefetchsize 64
overhead 6.0
transferrate 0.29 ;
commit;

CREATE regular TABLESPACE TABINDEXES
in nodegroup ng_all
PAGESIZE 32K MANAGED BY DATABASE
USING (
device '/dev/ridx1p $N' 133120,
device '/dev/ridx2p $N' 133120
)
```



```

BUFFERPOOL BP32K
extentsize 16
prefetchsize 64
overhead 6.0
transferrate 0.29;
commit;

```

```

CREATE TEMPORARY TABLESPACE TEMPSP4K
  PAGESIZE 4K MANAGED BY DATABASE
  USING (
device '/dev/rtm1p $N' 4276224,
device '/dev/rtm2p $N' 4276224,
device '/dev/rtm3p $N' 4276224
)

```

```

BUFFERPOOL IBMDEFAULTBP
extentsize 32
prefetchsize 192
overhead 6.0
transferrate 0.04;
commit;

```

```

CREATE TEMPORARY TABLESPACE TEMPSP32K
  PAGESIZE 32K MANAGED BY DATABASE
  USING (
device '/dev/rtemp1p $N' 534528,
device '/dev/rtemp2p $N' 534528,
device '/dev/rtemp3p $N' 534528
)

```

```

BUFFERPOOL BPTM32K
extentsize 16
prefetchsize 96
overhead 6.0
transferrate 0.29;
commit;

```

```

CREATE regular TABLESPACE TABSTAGE
  in nodegroup ng_all
  PAGESIZE 32K MANAGED BY DATABASE
  USING (
device '/dev/rstg1p $N' 139264,
device '/dev/rstg2p $N' 139264
)

```

```

BUFFERPOOL BPTM32K
extentsize 16
prefetchsize 64
overhead 6.0
transferrate 0.29 ;
commit;

```

```

CREATE REGULAR TABLESPACE SMALL
  in nodegroup ng_node1
  pagesize 4K
  managed by system
  using ('/db/small')
  bufferpool IBMDEFAULTBP;
COMMIT WORK;

```

```

drop TABLESPACE TEMPSPACE1;
commit;

```

B.9 createUfTables.ddl

```

CREATE TABLE TPCDTEMP.ORDERS_NEW ( APP_ID INTEGER
NOT NULL,
  O_ORDERKEY BIGINT NOT NULL,
  O_CUSTKEY INTEGER NOT NULL,
  O_ORDERSTATUS CHAR(1) NOT NULL,
  O_TOTALPRICE FLOAT NOT NULL,
  O_ORDERDATE DATE NOT NULL,
  O_ORDERPRIORITY CHAR(15) NOT NULL,

```

```

  O_CLERK CHAR(15) NOT NULL,
  O_SHIPPRIORITY INTEGER NOT NULL,
  O_COMMENT VARCHAR(79) NOT NULL WITH
DEFAULT)
  PARTITIONING KEY (O_ORDERKEY)
  IN TABSTAGE ;

```

```

CREATE TABLE TPCDTEMP.ORDERS_DEL ( APP_ID INTEGER
NOT NULL,
  O_ORDERKEY BIGINT NOT NULL)
  PARTITIONING KEY (O_ORDERKEY)
  IN TABSTAGE ;

```

```

CREATE TABLE TPCDTEMP.LINEITEM_NEW ( APP_ID INTEGER
NOT NULL,
  L_ORDERKEY BIGINT NOT NULL,
  L_PARTKEY INTEGER NOT NULL,
  L_SUPPKEY INTEGER NOT NULL,
  L_LINENUMBER INTEGER NOT NULL,
  L_QUANTITY FLOAT NOT NULL,
  L_EXTENDEDPRICE FLOAT NOT NULL,
  L_DISCOUNT FLOAT NOT NULL,
  L_TAX FLOAT NOT NULL,
  L_RETURNFLAG CHAR(1) NOT NULL,
  L_LINESTATUS CHAR(1) NOT NULL,
  L_SHIPDATE DATE NOT NULL,
  L_COMMITDATE DATE NOT NULL,
  L_RECEIPTDATE DATE NOT NULL,
  L_SHIPINSTRUCT CHAR(25) NOT NULL,
  L_SHIPMODE CHAR(10) NOT NULL,
  L_COMMENT VARCHAR(44) NOT NULL WITH
DEFAULT)
  PARTITIONING KEY (L_ORDERKEY)
  IN TABSTAGE ;

```

```

CREATE INDEX TPCDTEMP.I_ORDERS_NEW ON
TPCDTEMP.ORDERS_NEW
( APP_ID,
  O_ORDERKEY,
  O_CUSTKEY,
  O_ORDERSTATUS,
  O_TOTALPRICE,
  O_ORDERDATE,
  O_ORDERPRIORITY,
  O_CLERK,
  O_SHIPPRIORITY,
  O_COMMENT)
PCTFREE 0;

```

```

CREATE INDEX TPCDTEMP.I_LINEITEM_NEW ON
TPCDTEMP.LINEITEM_NEW (APP_ID) PCTFREE 0;

```

```

CREATE UNIQUE INDEX TPCDTEMP.I_ORDERS_DEL ON
TPCDTEMP.ORDERS_DEL (APP_ID, O_ORDERKEY) PCTFREE 0;
COMMIT WORK;

```

```

ALTER TABLE TPCDTEMP.ORDERS_NEW LOCKSIZE TABLE;
ALTER TABLE TPCDTEMP.ORDERS_DEL LOCKSIZE TABLE;
ALTER TABLE TPCDTEMP.LINEITEM_NEW LOCKSIZE TABLE;
COMMIT WORK;

```

B.10 deleteUfTables.ddl

```

import from /dev/null of del replace into TPCDTEMP.ORDERS_NEW;
import from /dev/null of del replace into TPCDTEMP.LINEITEM_NEW;
import from /dev/null of del replace into TPCDTEMP.ORDERS_DEL;

```

B.11 create_tables.ddl

```
CREATE TABLE TPCD.NATION ( N_NATIONKEY INTEGER NOT
NULL,
```

```
    N_NAME    CHAR(25) NOT NULL,
    N_REGIONKEY INTEGER NOT NULL,
    N_COMMENT  VARCHAR(152) NOT NULL)
```

```
IN SMALL;
```

```
CREATE TABLE TPCD.REGION ( R_REGIONKEY INTEGER NOT
NULL,
```

```
    R_NAME    CHAR(25) NOT NULL,
    R_COMMENT  VARCHAR(152) NOT NULL)
```

```
IN SMALL;
```

```
CREATE TABLE TPCD.PART ( P_PARTKEY  INTEGER NOT
NULL,
```

```
    P_NAME    VARCHAR(55) NOT NULL,
    P_MFGR    CHAR(25) NOT NULL,
    P_BRAND   CHAR(10) NOT NULL,
    P_TYPE    VARCHAR(25) NOT NULL,
    P_SIZE    INTEGER NOT NULL,
    P_CONTAINER CHAR(10) NOT NULL,
    P_RETAILPRICE FLOAT NOT NULL,
    P_COMMENT  VARCHAR(23) NOT NULL )
```

```
IN TABDATA
```

```
INDEX IN TABINDEXES;
```

```
CREATE TABLE TPCD.SUPPLIER ( S_SUPPKEY  INTEGER NOT
NULL,
```

```
    S_NAME    CHAR(25) NOT NULL,
    S_ADDRESS  VARCHAR(40) NOT NULL,
    S_NATIONKEY INTEGER NOT NULL,
    S_PHONE    CHAR(15) NOT NULL,
    S_ACCTBAL  FLOAT NOT NULL,
    S_COMMENT  VARCHAR(101) NOT NULL)
```

```
IN TABDATA
```

```
INDEX IN TABINDEXES;
```

```
CREATE TABLE TPCD.PARTSUPP ( PS_PARTKEY  INTEGER
NOT NULL,
```

```
    PS_SUPPKEY INTEGER NOT NULL,
    PS_AVAILQTY INTEGER NOT NULL,
    PS_SUPPLYCOST FLOAT NOT NULL,
    PS_COMMENT  VARCHAR(199) NOT NULL )
```

```
IN TABDATA
```

```
INDEX IN TABINDEXES;
```

```
CREATE TABLE TPCD.CUSTOMER ( C_CUSTKEY  INTEGER
NOT NULL,
```

```
    C_NAME    VARCHAR(25) NOT NULL,
    C_ADDRESS  VARCHAR(40) NOT NULL,
    C_NATIONKEY INTEGER NOT NULL,
    C_PHONE    CHAR(15) NOT NULL,
    C_ACCTBAL  FLOAT NOT NULL,
    C_MKTSEGMENT CHAR(10) NOT NULL,
    C_COMMENT  VARCHAR(117) NOT NULL)
```

```
IN TABDATA
```

```
INDEX IN TABINDEXES;
```

```
CREATE TABLE TPCD.ORDERS ( O_ORDERKEY  BIGINT NOT
NULL,
```

```
    O_CUSTKEY  INTEGER NOT NULL,
    O_ORDERSTATUS CHAR(1) NOT NULL,
    O_TOTALPRICE FLOAT NOT NULL,
    O_ORDERDATE  DATE NOT NULL,
    O_ORDERPRIORITY CHAR(15) NOT NULL,
    O_CLERK     CHAR(15) NOT NULL,
    O_SHIPPRIORITY INTEGER NOT NULL,
    O_COMMENT   VARCHAR(79) NOT NULL)
```

```
ORGANIZE BY (O_ORDERDATE)
```

```
IN TABDATA
```

```
INDEX IN TABINDEXES;
```

```
CREATE TABLE TPCD.LINEITEM ( L_ORDERKEY  BIGINT NOT
NULL,
```

```
    L_PARTKEY  INTEGER NOT NULL,
    L_SUPPKEY  INTEGER NOT NULL,
    L_LINENUMBER INTEGER NOT NULL,
    L_QUANTITY  FLOAT NOT NULL,
    L_EXTENDEDPRICE FLOAT NOT NULL,
    L_DISCOUNT  FLOAT NOT NULL,
    L_TAX        FLOAT NOT NULL,
    L_RETURNFLAG CHAR(1) NOT NULL,
    L_LINestatus CHAR(1) NOT NULL,
    L_SHIPDATE  DATE NOT NULL,
    L_COMMITDATE DATE NOT NULL,
    L_RECEIPTDATE DATE NOT NULL,
    L_SHIPINSTRUCT CHAR(25) NOT NULL,
    L_SHIPMODE   CHAR(10) NOT NULL,
    L_COMMENT   VARCHAR(44) NOT NULL)
```

```
ORGANIZE BY (L_SHIPDATE)
```

```
IN TABDATA
```

```
INDEX IN TABINDEXES;
```

```
COMMIT WORK;
```

B.12 load.sh

```
#!/bin/ksh
messages=${TPCD_TMP_DIR}
rawdata=${TPCD_INPUT}
custom=${TPCD_DDL_PATH}
```

```
echo "Load Summary Time: " > ${messages}/loadstatus.out
```

```
db2 connect to tpcd;
```

```
echo "Loading Nation at "`date` >> ${messages}/loadstatus.out
db2 "load from ${rawdata}1/nation.tbl of del modified by coldel|
fastparse noheader messages /dev/null replace i
nto TPCD.NATION nonrecoverable cpu_parallelism 1"
```

```
echo "Loading Region at "`date` >> ${messages}/loadstatus.out
db2 "load from ${rawdata}1/region.tbl of del modified by coldel|
fastparse noheader messages /dev/null replace i
nto TPCD.REGION nonrecoverable cpu_parallelism 1"
```

```
echo "Loading Lineitem at "`date` >> ${messages}/loadstatus.out
db2 -tvf ${custom}/load_lineitem.ddl
```

```
#
```

```
echo "Loading Orders at "`date` >> ${messages}/loadstatus.out
db2 -tvf ${custom}/load_orders.ddl
```

```
#
```

```
echo "Loading Partsupp at "`date` >> ${messages}/loadstatus.out
db2 -tvf ${custom}/load_partsupp.ddl
```

```
#
```

```
echo "Loading Customer at "`date` >> ${messages}/loadstatus.out
db2 -tvf ${custom}/load_customer.ddl
```

```
#
```

```
echo "Loading Part at "`date` >> ${messages}/loadstatus.out
db2 -tvf ${custom}/load_part.ddl
```

```
#
```

```
echo "Loading Supplier at "`date` >> ${messages}/loadstatus.out
db2 -tvf ${custom}/load_supplier.ddl
```

```
#
```

```
db2 commit;
```

```
db2 terminate;
```

```
echo "Finished Loading at "`date` >> ${messages}/loadstatus.out
echo "-----" >> ${messages}/loadstatus.out
```

B.13 load_lineitem.ddl

load from

```
lineitem.1, lineitem.2, lineitem.3, lineitem.4,
lineitem.5, lineitem.6, lineitem.7, lineitem.8,
lineitem.9, lineitem.10, lineitem.11, lineitem.12,
lineitem.13, lineitem.14, lineitem.15, lineitem.16,
lineitem.17, lineitem.18, lineitem.19, lineitem.20,
lineitem.21, lineitem.22, lineitem.23, lineitem.24,
lineitem.25, lineitem.26, lineitem.27, lineitem.28,
lineitem.29, lineitem.30, lineitem.31, lineitem.32
of del modified by coldel|
fastparse
messages /dev/null
replace into TPCD.lineitem nonrecoverable cpu_parallelism 1
partitioned db config mode load_only
part_file_location /rawdata1/LINKS/load_links;
```

B.14 load_orders.ddl

load from

```
orders.1, orders.2, orders.3, orders.4,
orders.5, orders.6, orders.7, orders.8,
orders.9, orders.10, orders.11, orders.12,
orders.13, orders.14, orders.15, orders.16,
orders.17, orders.18, orders.19, orders.20,
orders.21, orders.22, orders.23, orders.24,
orders.25, orders.26, orders.27, orders.28,
orders.29, orders.30, orders.31, orders.32
of del modified by coldel|
fastparse
messages /dev/null
replace into TPCD.orders nonrecoverable cpu_parallelism 1
partitioned db config mode load_only
part_file_location /rawdata1/LINKS/load_links;
```

B.15 load_partsupp.ddl

load from

```
partsupp.1, partsupp.2, partsupp.3, partsupp.4,
partsupp.5, partsupp.6, partsupp.7, partsupp.8,
partsupp.9, partsupp.10, partsupp.11, partsupp.12,
partsupp.13, partsupp.14, partsupp.15, partsupp.16,
partsupp.17, partsupp.18, partsupp.19, partsupp.20,
partsupp.21, partsupp.22, partsupp.23, partsupp.24,
partsupp.25, partsupp.26, partsupp.27, partsupp.28,
partsupp.29, partsupp.30, partsupp.31, partsupp.32
of del modified by coldel|
fastparse
messages /dev/null
replace into TPCD.partsupp nonrecoverable cpu_parallelism 1
partitioned db config mode load_only
part_file_location /rawdata1/LINKS/load_links;
```

B.16 load_part.ddl

load from

```
part.1, part.2, part.3, part.4,
part.5, part.6, part.7, part.8,
part.9, part.10, part.11, part.12,
part.13, part.14, part.15, part.16,
part.17, part.18, part.19, part.20,
part.21, part.22, part.23, part.24,
part.25, part.26, part.27, part.28,
part.29, part.30, part.31, part.32
of del modified by coldel|
fastparse
messages /dev/null
replace into TPCD.part nonrecoverable cpu_parallelism 1
```

```
partitioned db config mode load_only
part_file_location /rawdata1/LINKS/load_links;
```

B.17 load_customer.ddl

load from

```
customer.1, customer.2, customer.3, customer.4,
customer.5, customer.6, customer.7, customer.8,
customer.9, customer.10, customer.11, customer.12,
customer.13, customer.14, customer.15, customer.16,
customer.17, customer.18, customer.19, customer.20,
customer.21, customer.22, customer.23, customer.24,
customer.25, customer.26, customer.27, customer.28,
customer.29, customer.30, customer.31, customer.32
of del modified by coldel|
fastparse
messages /dev/null
replace into TPCD.customer nonrecoverable cpu_parallelism 1
partitioned db config mode load_only
part_file_location /rawdata1/LINKS/load_links;
```

B.18 load_supplier.ddl

load from

```
supplier.1, supplier.2, supplier.3, supplier.4,
supplier.5, supplier.6, supplier.7, supplier.8,
supplier.9, supplier.10, supplier.11, supplier.12,
supplier.13, supplier.14, supplier.15, supplier.16,
supplier.17, supplier.18, supplier.19, supplier.20,
supplier.21, supplier.22, supplier.23, supplier.24,
supplier.25, supplier.26, supplier.27, supplier.28,
supplier.29, supplier.30, supplier.31, supplier.32
of del modified by coldel|
fastparse
messages /dev/null
replace into TPCD.supplier nonrecoverable cpu_parallelism 1
partitioned db config mode load_only
part_file_location /rawdata1/LINKS/load_links;
```

B.19 create_index.ddl

```
values(current timestamp);
CREATE UNIQUE INDEX TPCD.R_RK ON TPCD.REGION
(R_REGIONKEY ASC) PCTFREE 0;
commit work;
alter table tpcd.region add primary key (r_regionkey);
commit work;
```

```
values(current timestamp);
CREATE UNIQUE INDEX TPCD.N_NK ON TPCD.NATION
(N_NATIONKEY ASC) PCTFREE 0;
commit work;
alter table tpcd.nation add primary key (n_nationkey);
commit work;
```

```
values(current timestamp);
CREATE INDEX TPCD.N_RK ON TPCD.NATION
(N_REGIONKEY ASC) PCTFREE 0;
commit work;
```

```
values(current timestamp);
CREATE UNIQUE INDEX TPCD.S_SK ON TPCD.SUPPLIER
(S_SUPPKEY ASC) PCTFREE 0;
commit work;
alter table tpcd.supplier add primary key (s_suppkey);
commit work;
```

```
values(current timestamp);
CREATE INDEX TPCD.S_NK ON TPCD.SUPPLIER
```

```

(S_NATIONKEY ASC) PCTFREE 0 ;
commit work;

values(current timestamp);
CREATE UNIQUE INDEX TPCD.PS_PKSK ON TPCD.PARTSUPP
(P_S_PARTKEY ASC, PS_SUPPKEY ASC) PCTFREE 0 ;
commit work;
alter table tpcd.partsupp add primary key (ps_partkey, ps_suppkey);
commit work;

values(current timestamp);
CREATE INDEX TPCD.PS_PK ON TPCD.PARTSUPP
(P_S_PARTKEY ASC) PCTFREE 0 ;
commit work;

values(current timestamp);
CREATE UNIQUE INDEX TPCD.PS_SKPK ON TPCD.PARTSUPP
(P_S_SUPPKEY ASC, PS_PARTKEY ASC) PCTFREE 0 ;
commit work;

values(current timestamp);
CREATE INDEX TPCD.PS_SK ON TPCD.PARTSUPP
(P_S_SUPPKEY ASC) PCTFREE 0 ;
commit work;

values(current timestamp);
CREATE UNIQUE INDEX TPCD.P_PK ON TPCD.PART
(P_PARTKEY ASC) PCTFREE 0 ;
commit work;
alter table tpcd.part add primary key (p_partkey);
commit work;

values(current timestamp);
CREATE UNIQUE INDEX TPCD.C_CK ON TPCD.CUSTOMER
(C_CUSTKEY ASC) PCTFREE 0 ;
commit work;
alter table tpcd.customer add primary key (c_custkey);
commit work;

values(current timestamp);
CREATE INDEX TPCD.C_NK ON TPCD.CUSTOMER
(C_NATIONKEY ASC) PCTFREE 0 ;
commit work;

values(current timestamp);
CREATE UNIQUE INDEX TPCD.O_OK ON TPCD.ORDERS
(O_ORDERKEY ASC) PCTFREE 3 ;
commit work;
alter table tpcd.orders add primary key (o_orderkey);
commit work;

values(current timestamp);
CREATE INDEX TPCD.O_CK ON TPCD.ORDERS
(O_CUSTKEY ASC) PCTFREE 3 ;
commit work;

values(current timestamp);
CREATE UNIQUE INDEX TPCD.L_OKLN ON TPCD.LINEITEM
(L_ORDERKEY ASC, L_LINENUMBER ASC) PCTFREE 3 ;
commit work;
alter table tpcd.lineitem add primary key (l_orderkey, l_linenumber);
commit work;

values(current timestamp);

select substr(tbname,1,10),substr(name,1,18),create_time from
sysibm.sysindexes where tbcreator='TPCD' order by 3;
select substr(tbname,1,10),
substr(name,1,18),indextype,substr(colnames,1,40) from

```

```

sysibm.sysindexes where name like 'SQL%' and tbcreator ='TPCD'
order by 1,2;

```

B.20 runstats.ddl

```

RUNSTATS ON TABLE TPCD.NATION WITH DISTRIBUTION on all
columns
and columns (
n_name like statistics,
n_comment like statistics )
AND INDEXES ALL;
commit;
RUNSTATS ON TABLE TPCD.REGION WITH DISTRIBUTION on all
columns
and columns (
r_name like statistics,
r_comment like statistics )
AND INDEXES ALL;
commit;
RUNSTATS ON TABLE TPCD.SUPPLIER WITH DISTRIBUTION on
all columns
and columns (
s_name like statistics,
s_address like statistics,
s_phone like statistics,
s_comment like statistics)
AND INDEXES ALL;
commit;
RUNSTATS ON TABLE TPCD.PART WITH DISTRIBUTION on all
columns
and columns (
p_name like statistics,
p_mfgr like statistics,
p_brand like statistics,
p_type like statistics,
p_container like statistics,
p_comment like statistics)
AND INDEXES ALL;
commit;
RUNSTATS ON TABLE TPCD.PARTSUPP WITH DISTRIBUTION on
all columns
and columns (
ps_comment like statistics)
AND INDEXES ALL;
commit;
RUNSTATS ON TABLE TPCD.CUSTOMER WITH DISTRIBUTION on
all columns
and columns (
c_name like statistics,
c_address like statistics,
c_phone like statistics,
c_mktsegment like statistics,
c_comment like statistics)
AND INDEXES ALL;
commit;
RUNSTATS ON TABLE TPCD.ORDERS WITH DISTRIBUTION on
all columns
and columns (
o_orderstatus like statistics,
o_orderpriority like statistics,
o_clerk like statistics,
o_comment like statistics)
AND INDEXES ALL;
commit;
RUNSTATS ON TABLE TPCD.LINEITEM WITH DISTRIBUTION on
all columns
and columns (
l_returnflag like statistics,
l_linestatus like statistics,
l_shipinstruct like statistics,

```

```
_l_shipmode like statistics,  
_l_comment like statistics)  
AND INDEXES ALL;  
COMMIT WORK;
```

B.21 db2set_run.sh

```
#!/bin/ksh  
db2set DB2OPTIONS="-t -v +c"  
db2set DB2_EXTENDED_OPTIMIZATION=Y  
db2set DB2_ANTIJOIN=ON  
db2set DB2_FORCE_FCM_BP=ON  
db2set DB2MEMDISCLAIM=ON  
db2set DB2BPVARS=/tpc/tpcd/tpcd/custom/bpvars.cfg  
db2set DB2_PARALLEL_IO=""  
db2set DB2_PINNED_BP=Y  
db2set DB2_LGPAGE_BP=Y
```

B.22 dbmcfg_run

```
update database manager configuration using  
comm_bandwidth 10  
numdb 1  
diagpath /db2dump/db2dump  
diaglevel 3  
cpuspeed 5.235149e-07  
sheapthres 2800000  
num_initagents 30  
num_poolagents -1  
max_querydegree -1  
FCM_NUM_BUFFERS 262144  
intra_parallel no;
```

```
get database manager configuration;
```

B.23 dbcfg_run

```
update database configuration for tpcd using  
dft_queryopt 7  
num_freqvalues 0  
num_quantiles 600  
stat_heap_sz 4384  
dbheap 7500  
logbufsz 1024  
util_heap_sz 5000  
locklist 8196  
softmax 300  
app_ctl_heap_sz 512  
sortheap 20000  
stmtheap 20000  
applheapsz 156  
maxlocks 13  
chnpggs_thresh 70  
num_iocleaners 1  
num_ioservers 2  
maxappls 365  
maxfilop 1024  
logfilsiz 8192  
logprimary 50  
SHEAPTHRES_SHR 250  
DATABASE_MEMORY 654556  
logsecond 5;
```

B.24 tpcd.setup

```
TPCD_VERSION=2  
TPCD_PLATFORM=aix  
TPCD_DBNAME=TPCD  
TPCD_WORKLOAD=H
```

```
TPCD_AUDIT_DIR=/tpc/tpcd/tpcd  
TPCD_PRODUCT=v5  
TPCD_MODE=mln  
TPCD_PHYS_NODE=4  
TPCD_LN_PER_PN=4  
TPCD_SF=1000  
TPCD_BUILD_STAGE=ALL  
TPCD_DBPATH=/db  
TPCD_DDLPATH=/tpc/tpcd/tpcd/custom  
TPCD_BUFFERPOOL_DEF=create_bpools.ddl  
TPCD_BUFFERPOOL_DEF_RUN=NULL  
TPCD_NODEGROUP_DEF=create_nodegroups.ddl  
TPCD_EXPLAIN_DDL=explain.ddl  
TPCD_TBSP_DDL=create_tbspaces.ddl  
TPCD_DDL=create_tables.ddl  
TPCD_QUAL_TBSP_DDL=NULL  
TPCD_QUAL_DDL=NULL  
TPCD_INDEXDDL=create_indexes.ddl  
TPCD_EXTRAINDEX=no  
TPCD_ADD_RI=NULL  
TPCD_AST=NULL  
TPCD_RUNSTATS=runstats.ddl  
TPCD_RUNSTATSHORT=  
TPCD_DBGEN=/tpc/tpcd/tpcd/appendix.v2/dbgen.211b  
TPCD_INPUT=/rawdata  
TPCD_QUAL_INPUT=NULL  
TPCD_TAILOR_DIR=/tmp/tpcd  
TPCD_EARLYINDEX=no  
TPCD_LOAD_DB2SET_SCRIPT=db2set_load.sh  
TPCD_LOAD_CONFIGFILE=dbcfg_load  
TPCD_LOAD_DBM_CONFIGFILE=dbmcfg_load  
TPCD_LOAD_QUALCONFIGFILE=NULL  
TPCD_LOAD_DBM_QUALCONFIGFILE=NULL  
TPCD_LOADSTATS=no  
TPCD_TEMP=  
TPCD_SORTBUF=  
TPCD_LOAD_PARALLELISM=0  
TPCD_COPY_DIR=NULL  
TPCD_FASTPARSE=yes  
TPCD_BACKUP_DIR=  
TPCD_LOGPRIMARY=NULL  
TPCD_LOGFILSIZ=NULL  
TPCD_LOGSECOND=NULL  
TPCD_LOG_DIR=NULL  
TPCD_LOG_DIR_SETUP_SCRIPT=NULL  
TPCD_LOG_QUAL_DIR=NULL  
TPCD_LOG=no  
TPCD_DB2SET_SCRIPT=db2set_run.sh  
TPCD_CONFIGFILE=dbcfg_run  
TPCD_DBM_CONFIG=dbmcfg_run  
TPCD_QUALCONFIGFILE=NULL  
TPCD_DBM_QUALCONFIG=NULL  
TPCD_MACHINE=big  
TPCD_SMPDEGREE=1  
TPCD_AGENTPRI=NULL  
TPCD_ACTIVATE=no  
TPCD_AUDIT=yes  
TPCD_TMP_DIR=/tmp/tpcd/TEMP  
TPCD_SHARED_TEMP_FULL_PATHNAME=/tpc/tpcd/tpcd/tmp  
TPCD_QUERY_TEMPLATE_DIR=standard.V2  
TPCD_QUAL_DBNAME=NULL  
TPCD_NUMSTREAM=7  
TPCD_FLATFILES=/rawdata1/LINKS  
TPCD_STAGING_TABLE_DDL=createUfTables.ddl  
TPCD_PRELOAD_STAGING_TABLE_SCRIPT=loadSampleUf.sh  
TPCD_DELETE_STAGING_TABLE_SQL=deleteUfTables.ddl  
TPCD_UPDATE_IMPORT=false  
TPCD_SPLIT_UPDATES=40  
TPCD_CONCURRENT_INSERTS=20  
TPCD_CONCURRENT_INSERTS_LOAD=1
```

```

TPCD_SPLIT_DELETES=64
TPCD_CONCURRENT_DELETES=32
TPCD_GEN_UPDATEPAIRS=24
TPCD_GENERATE_SEED_FILE=yes
TPCD_RUN_ON_MULTIPLE_NODES=NULL
TPCD_STATS_INTERVAL=5
TPCD_STATS_THRU_INT=30
TPCD_PS_INTERVAL=900
TPCD_PS_THRU_INT=1800
TPCD_GATHER_STATS=off
TPCD_UFTEMP=tabdata
TPCD_HAVECOMPILER=yes
TPCD_SLEEP=5
TPCD_INLISTMAX=default
TPCD_LOAD_SCRIPT=load.sh
TPCD_LOAD_SCRIPT_QUAL=NULL
TPCD_ROOTPRIV=yes
TPCD_DB2LOG=db2dump
TPCD_APPEND_ON=no

```

B.25 buildtpcd

```

#!/usr/bin/perl
# usage buildtpcd [QUAL]

# ASSUMPTIONS: all ddl files have commits in them!
($myName = $0) =~ s@.*@/@; $usage="
Usage: buildtpcd [QUAL]
       where QUAL is the optional parameter saying to build the qualifica-
       tion
           database (sf = .1 = 100MB)\n";

$qual="";
if (@ARGV == 1)
{
    $qual = $ARGV[0];
}

# get TPC-D specific environment variables
require 'getvars';

# Use the macros in here so that they can handle the platform differ-
# ences.
# macro.pl should be sourced from cmvc, other people wrote and
# maintain it.
require "macro.pl";
require "tpcdmacro.pl";

# Make output unbuffered.
select(STDOUT);
$| = 1;

# verify that necessary environment variables for building the database
# are present. Default those that aren't necessary
require "version";
$instance=$ENV{"DB2INSTANCE"};
if (length($ENV{"TPCD_PLATFORM"}) <= 0)
{
    die "TPCD_PLATFORM environment variable not set\n";
}
$platform=$ENV{"TPCD_PLATFORM"};
if ( $platform eq "nt" )
{
    $sep="&";
}
else
{
    $sep=",";
}

```

```

}
if ((length($ENV{"TPCD_BUILD_STAGE"}) <= 0) ||
($ENV{"TPCD_BUILD_STAGE"}) eq "NULL" )
{
    $ENV{"TPCD_BUILD_STAGE"} = "ALL";
}
if (length($ENV{"TPCD_PRODUCT"}) <= 0)
{
    die "Must set TPCD_PRODUCT env't var.\n";
}
if ( length($ENV{"TPCD_DBNAME"}) <= 0 )
{
    die "TPCD_DBNAME environment variable not set\n";
}
if (length($ENV{"TPCD_MODE"}) <= 0)
{
    die "TPCD_MODE environment variable not set - uni/smp/mln \n";
}
if (length($ENV{"TPCD_SF"}) <= 0)
{
    die "TPCD_SF environment variable not set\n";
}
if (length($ENV{"TPCD_DBPATH"}) <= 1)
{
    # if no db pathname specified, build the db in the home directory
    if ( $platform eq "aix" || $platform eq "sun" || $platform eq "ptx" ||
$platform eq "hp")
    {
        $ENV{"TPCD_DBPATH"} = $ENV{"HOME"};
    }
    elsif ( $platform eq "nt" )
    {
        $ENV{"TPCD_DBPATH"} = $ENV{"HOMEDRIVE"};
    }
    else
    {
        die "platform $platform not supported yet\n";
    }
}
if (length($ENV{"TPCD_DDL_PATH"}) <= 0)
{
    # if no db pathname specified, use default
    $ENV{"TPCD_DBPATH"} =
"/afs/tor/groups/dbp/perf/benchmark/tpcd/ddl/vanilla";
}
if (length($ENV{"TPCD_GENERATE_SEED_FILE"}) <= 0)
{
    # if no db pathname specified, use default
    $ENV{"TPCD_GENERATE_SEED_FILE"} = "no";
}
if (length($ENV{"TPCD_DDL"}) <= 0)
{
    $ENV{"TPCD_DDL"} = "dss.ddl";
}
if (length($ENV{"TPCD_STAGING_TABLE_DDL"}) <= 0)
{
    $ENV{"TPCD_STAGING_TABLE_DDL"} = "NULL";
}
if (length($ENV{"TPCD_PRELOAD_STAGING_TABLE_SCRIPT"}) <= 0)
{
    $ENV{"TPCD_PRELOAD_STAGING_TABLE_DDL"} = "NULL";
}
if (length($ENV{"TPCD_DELETE_STAGING_TABLE_SQL"}) <= 0)
{
    $ENV{"TPCD_DELETE_STAGING_TABLE_DDL"} = "NULL";
}
if (length($ENV{"TPCD_TBSP_DDL"}) <= 0)
{
    $ENV{"TPCD_TBSP_DDL"} = "dss.tbsp.ddl";
}

```

```

}
if (length($ENV{"TPCD_INDEXDDL"}) <= 0)
{
    $ENV{"TPCD_INDEXDDL"} = "dss.index";
}
if (length($ENV{"TPCD_RUNSTATS"}) <= 0)
{
    $ENV{"TPCD_RUNSTATS"} = "dss.runstats";
}
if (length($ENV{"TPCD_RUNSTATSHORT"}) <= 0)
{
    $ENV{"TPCD_RUNSTATSHORT"} = "NULL";
}
if (length($ENV{"TPCD_ADD_RI"}) <= 0)
{
    $ENV{"TPCD_ADD_RI"} = "NULL";
}
if (length($ENV{"TPCD_AST"}) <= 0)
{
    $ENV{"TPCD_AST"} = "NULL";
}
if ( ($ENV{"TPCD_INPUT"}) eq "NULL" )
{
    if (length($ENV{"TPCD_DBGEN"}) <= 0)
    {
        die "Must set TPCD_DBGEN if pregenerated flatfiles are not provided (TPCD_INPUT=NULL)\n";
    }
}
if ( $qual eq "QUAL" )
{
    if ( ($ENV{"TPCD_QUAL_INPUT"}) eq "NULL" )
    {
        if (length($ENV{"TPCD_DBGEN"}) <= 0)
        {
            die "Must set TPCD_DBGEN if pregenerated flatfiles are not provided (TPCD_QUAL_INPUT=NULL)\n";
        }
    }
}
if (length($ENV{"TPCD_TEMP"}) <= 1)
{
    $ENV{"TPCD_TEMP"} = "/u/$instance/sql/lib/tmp";
}
if (length($ENV{"TPCD_SORTBUF"}) <= 0)
{
    $ENV{"TPCD_SORTBUF"} = 4096;
}
if (length($ENV{"TPCD_LOAD_PARALLELISM"}) <= 0)
{
    $ENV{"TPCD_LOAD_PARALLELISM"} = 0;
}
if (length($ENV{"TPCD_LOADSTATS"}) <= 0)
{
    $ENV{"TPCD_LOADSTATS"} = "no";
}
if (length($ENV{"TPCD_COPY_DIR"}) <= 0)
{
    $ENV{"TPCD_COPY_DIR"} = "${delim}dev${delim}null";
}
if (length($ENV{"TPCD_FASTPARSE"}) <= 0)
{
    $ENV{"TPCD_FASTPARSE"} = "no";
}
if (length($ENV{"TPCD_BACKUP_DIR"}) <= 0)
{
    $ENV{"TPCD_BACKUP_DIR"} = "${delim}dev${delim}null";
}
if (length($ENV{"TPCD_LOG"}) <= 0)

```

```

{
    $ENV{"TPCD_LOG"} = "no";
}
if (length($ENV{"TPCD_LOGPRIMARY"}) <= 0)
{
    $ENV{"TPCD_LOGPRIMARY"} = "NULL";
}
if (length($ENV{"TPCD_LOGSECOND"}) <= 0)
{
    $ENV{"TPCD_LOGSECOND"} = "NULL";
}
if (length($ENV{"TPCD_LOGFILSIZ"}) <= 0)
{
    $ENV{"TPCD_LOGFILSIZ"} = "NULL";
}
if (length($ENV{"TPCD_LOG_DIR"}) <= 0)
{
    $ENV{"TPCD_LOG_DIR"} = "NULL";
}
if (length($ENV{"TPCD_LOG_DIR_SETUP_SCRIPT"}) <= 0)
{
    $ENV{"TPCD_LOG_DIR_SETUP_SCRIPT"} = "NULL";
}
if (length($ENV{"TPCD_CONFIGFILE"}) <= 0)
{
    $ENV{"TPCD_CONFIGFILE"} = "dss.dbconfig";
}
if (length($ENV{"TPCD_DBM_CONFIG"}) <= 0)
{
    $ENV{"TPCD_DBM_CONFIG"} = "NULL";
}
if (length($ENV{"TPCD_MACHINE"}) <= 0)
{
    $ENV{"TPCD_MACHINE"} = "medium";
}
if (length($ENV{"TPCD_SMPDEGREE"}) <= 0)
{
    $ENV{"TPCD_SMPDEGREE"} = 1;
}
if (length($ENV{"TPCD_AGENTPRI"}) <= 0)
{
    $ENV{"TPCD_AGENTPRI"} = NULL;
}
if (length($ENV{"TPCD_ACTIVATE"}) <= 0)
{
    $ENV{"TPCD_ACTIVATE"} = "no";
}
if (length($ENV{"TPCD_AUDIT"}) <= 0)
{
    die "Must set TPCD_AUDIT env't var. Real audit timing sequence run if yes\n";
}
if (length($ENV{"TPCD_AUDIT_DIR"}) <= 0)
{
    die "TPCD_AUDIT_DIR environment variable not set\n";
}
if (length($ENV{"TPCD_LOAD_DB2SET_SCRIPT"}) <= 0)
{
    $ENV{"TPCD_LOAD_DB2SET_SCRIPT"}="NULL"
}
if (length($ENV{"TPCD_DB2SET_SCRIPT"}) <= 0)
{
    $ENV{"TPCD_DB2SET_SCRIPT"}="NULL"
}
if (length($ENV{"TPCD_BUFFERPOOL_DEF"}) <= 0)
{
    $ENV{"TPCD_BUFFERPOOL_DEF"}="NULL"
}
if (length($ENV{"TPCD_EXPLAIN_DDL"}) <= 0)
{

```

```

$ENV{"TPCD_EXPLAIN_DDL"}="NULL"
}
if (length($ENV{"TPCD_NODEGROUP_DEF"}) <= 0)
{
$ENV{"TPCD_NODEGROUP_DEF"}="NULL"
}
if (length($ENV{"TPCD_PHYS_NODE"}) <= 0)
{
$ENV{"TPCD_NODEGROUP_DEF"}="NULL"
}
if (length($ENV{"TPCD_APPEND_ON"}) <= 0)
{
$ENV{"TPCD_APPEND_ON"}="yes"
}

#set up local variables
$tpcdVersion=$ENV{"TPCD_VERSION"};
$buildStage=$ENV{"TPCD_BUILD_STAGE"};
$product=$ENV{"TPCD_PRODUCT"};
$dbname=$ENV{"TPCD_DBNAME"};
$mode=$ENV{"TPCD_MODE"};
$sf=$ENV{"TPCD_SF"};
$sfReal=$sf; # need a "saved" one for qualification stuff
$dbpath=$ENV{"TPCD_DBPATH"};
$ddlpath=$ENV{"TPCD_DDL_PATH"};
$ddl=$ENV{"TPCD_DDL"};
$stagingTbl=$ENV{"TPCD_STAGING_TABLE_DDL"};
$preloadSampleUF=$ENV{"TPCD_PRELOAD_STAGING_TABLE_SCRIPT"};
$deleteSampleUF=$ENV{"TPCD_DELETE_STAGING_TABLE_SQL"};
$buffpooldef=$ENV{"TPCD_BUFFERPOOL_DEF"};
$buffpooldef_run=$ENV{"TPCD_BUFFERPOOL_DEF_RUN"};
$nodegroupdef=$ENV{"TPCD_NODEGROUP_DEF"};
$tbpsddl=$ENV{"TPCD_TBSP_DDL"};
$indexddl=$ENV{"TPCD_INDEXDDL"};
$extraindex=$ENV{"TPCD_EXTRAINDEX"};
$runstats=$ENV{"TPCD_RUNSTATS"};
$runstatShort=$ENV{"TPCD_RUNSTATSHORT"};
$dbgen=$ENV{"TPCD_DBGEN"};
$input=$ENV{"TPCD_INPUT"};
$earlyindex=$ENV{"TPCD_EARLYINDEX"};
$idtemp=$ENV{"TPCD_TEMP"};
$sortbuf=$ENV{"TPCD_SORTBUF"};
$load_parallelism=$ENV{"TPCD_LOAD_PARALLELISM"};
$loadstats=$ENV{"TPCD_LOADSTATS"};
$copydir=$ENV{"TPCD_COPY_DIR"};
$fparse=$ENV{"TPCD_FASTPARSE"};
$addRI=$ENV{"TPCD_ADD_RI"};
$astFile=$ENV{"TPCD_AST"};
$genSeed=$ENV{"TPCD_GENERATE_SEED_FILE"};
$appendOn=$ENV{"TPCD_APPEND_ON"};

if ( $fparse eq "yes" )
{
$fastparse="FASTPARSE";
}
else
{
$fastparse=" ";
}
$backupdir=$ENV{"TPCD_BACKUP_DIR"};
$logprimary=$ENV{"TPCD_LOGPRIMARY"};
$logsecond=$ENV{"TPCD_LOGSECOND"};
$logfilsiz=$ENV{"TPCD_LOGFILSIZ"};
$log=$ENV{"TPCD_LOG"};
$logDir=$ENV{"TPCD_LOG_DIR"};
$logDirScript=$ENV{"TPCD_LOG_DIR_SETUP_SCRIPT"};
$machine=$ENV{"TPCD_MACHINE"};
$configfile=$ENV{"TPCD_CONFIGFILE"};
$dbmconfig=$ENV{"TPCD_DBM_CONFIG"};

```

```

$loadconfigfile=$ENV{"TPCD_LOAD_CONFIGFILE"};
$loadDBMconfig=$ENV{"TPCD_LOAD_DBM_CONFIGFILE"};
$smpdegree=$ENV{"TPCD_SMPDEGREE"};
$agentpri=$ENV{"TPCD_AGENTPRI"};
$activate=$ENV{"TPCD_ACTIVATE"};
$RealAudit=$ENV{"TPCD_AUDIT"};
$loadscript=$ENV{"TPCD_LOAD_SCRIPT"};
$auditDir=$ENV{"TPCD_AUDIT_DIR"};
$loadsetScript=$ENV{"TPCD_LOAD_DB2SET_SCRIPT"};
$setScript=$ENV{"TPCD_DB2SET_SCRIPT"};
$explainDDL=$ENV{"TPCD_EXPLAIN_DDL"};
$user=$ENV{"USER"};

# set up override of some parameters to override for qualification data-
base
if ( $qual eq "QUAL" )
{
$loadscript=$ENV{"TPCD_LOAD_SCRIPT_QUAL"};
if ( length($ENV{"TPCD_QUAL_DBNAME"}) <= 0 )
{
die "TPCD_QUAL_DBNAME environment variable not set\n";
}
$dbname=$ENV{"TPCD_QUAL_DBNAME"};

print "DBNAME= $dbname\n\n";

$sf=$ENV{"TPCD_QUAL_SF"};
if ( length($ENV{"TPCD_QUAL_DDL"}) <= 0 )
{
die "TPCD_QUAL_DDL environment variable not set\n";
}
$ddl=$ENV{"TPCD_QUAL_DDL"};
if ( length($ENV{"TPCD_QUAL_TBSP_DDL"}) <= 0 )
{
die "TPCD_QUAL_TBSP_DDL environment variable not set\n";
}
$tbpsddl=$ENV{"TPCD_QUAL_TBSP_DDL"};
$input=$ENV{"TPCD_QUAL_INPUT"};
if ( length($ENV{"TPCD_QUALCONFIGFILE"}) <= 0 )
{
die "TPCD_QUALCONFIGFILE environment variable not set\n";
}
$configfile=$ENV{"TPCD_QUALCONFIGFILE"};
if ( length($ENV{"TPCD_DBM_QUALCONFIG"}) <= 0 )
{
die "TPCD_DBM_QUALCONFIG environment variable not set\n";
}
$dbmconfig=$ENV{"TPCD_DBM_QUALCONFIG"};
if ( length($ENV{"TPCD_LOAD_QUALCONFIGFILE"}) <= 0 )
{
die "TPCD_LOAD_QUALCONFIGFILE environment variable not set\n";
}
$loadconfigfile=$ENV{"TPCD_LOAD_QUALCONFIGFILE"};
if ( length($ENV{"TPCD_LOAD_DBM_QUALCONFIGFILE"}) <= 0 )
{
die "TPCD_LOAD_DBM_QUALCONFIGFILE environment variable not set\n";
}
$loadDBMconfig=$ENV{"TPCD_LOAD_DBM_QUALCONFIGFILE"};
if (length($ENV{"TPCD_LOG_DIR"}) <= 0)
{
$ENV{"TPCD_LOG_DIR"} = "NULL";
}
$logDir=$ENV{"TPCD_LOG_QUAL_DIR"};
}

if (( $mode eq "uni" ) || ( $mode eq "smp" ))
{
$all_in="once";
}

```



```

$all_pn="once";
$once="once";
}
else
{
  $all_in="all_in";
  $all_pn="all_pn";
  $once="once";
}

# set up the config parms for the load, indexes and stats
if ($loadconfigfile eq "NULL")
{
  if ( ($machine eq "NULL") )
  {
    die "Neither a LOAD config file name not a machine size has been
specified!\n";
  }
  $ioclrs=1;
  $chngpgs=60;

  if ( $machine eq "small" )
  {
    $buffpage = 5000;
    $sorheap = 3000;
    $sheapthres = 8000;
    $util_heap_sz = 5000;
    $ioservers = 6;
  }
  elseif ( $machine eq "medium" )
  {
    $buffpage = 10000;
    $sorheap = 8000;
    $sheapthres = 20000;
    $util_heap_sz = 10000;
    $ioservers = 10;
  }
  elseif ( $machine eq "big" )
  {
    $buffpage = 30000;
    $sorheap = 20000;
    $sheapthres = 50000;
    $util_heap_sz = 30000;
    $ioservers = 20;
  }
  elseif ( $machine eq "sunsm" )
  {
    $buffpage = 60000;
    $sorheap = 20000;
    $sheapthres = 80000;
    $util_heap_sz = 30000;
    $ioservers = 80;
  }
  elseif ( $machine eq "eastwood" )
  {
    $buffpage = 80000;
    $sorheap = 50000;
    $sheapthres = 81000;
    $ioclrs = 4;
    $chngpgs = 30;
    $ioservers = 21;
    $util_heap_sz = 50000;
  }
}
# echo parameter settings to acknowledge what is being built
if ( $buildStage ne "ALL" )
{
  print " ***** STARTING the build process at the $buildStage Stage
*****\n";
}

```

```

print "Building a TPC-D Version $tpcdVersion $sf GB database on
$dbpath with: \n";
print "  Mode = $mode \n";
print "  Tablespace ddl in $ddlpath${delim}$tbspddl \n";
if ( $nodegroupdef ne "NULL" )
{
  print "  Nodegroup ddl in $ddlpath${delim}$nodegroupdef \n";
}
if ( $buffpooldef ne "NULL" )
{
  print "  Bufferpool ddl in $ddlpath${delim}$buffpooldef \n";
}
if ( $buffpooldef_run ne "NULL" )
{
  print "  Run Bufferpool ddl in $ddlpath${delim}$buffpooldef_run \n";
}
print "  Table ddl in $ddlpath${delim}$ddl \n";
print "  Index ddl in $ddlpath${delim}$indexddl \n";
if ( $extraindex ne "no" )
{
  print "  Indices to create after the load $ddlpath${delim}$extraindex \n";
}
if ( $loadscript eq "NULL" )
{
  if ( $input eq "NULL" )
  {
    print "  Data generated by DBGEN in $dbgen \n";
  }
  else
  {
    print "  Data loaded from flat files in $input \n";
  }
}
if ( $earlyindex eq "yes" )
{
  print "  Indexes created before loading \n";
}
else
{
  print "  Indexes created after loading \n";
}
if ( $addRI ne "NULL" )
{
  print "  RI being used from $ddlpath${delim}$addRI \n";
}
if ( $astFile ne "NULL" )
{
  print "  AST being used from $ddlpath${delim}$astFile \n";
}
if ( $loadstats eq "yes" )
{
  if ( $earlyindex eq "yes" )
  {
    print "  Statistics for tables and indexes gathered during load \n";
  }
  else
  {
    if ( $runstatShort eq "NULL" )
    {
      print "  Statistics for tables and indexes gathered after load using
$ddlpath${delim}$runstats \n";
    }
    else
    {
      print "  Statistics for tables and indexes gathered after load using
$ddlpath${delim}$runstats and $ddlpath${delim}$runstatShort \n";
    }
  }
}
else

```

```

{
  if ( $runstatShort eq "NULL" )
  {
    print " Statistics for tables and indexes gathered after load using
$ddlpath${delim}$runstats \n";
  }
  else
  {
    print " Statistics for tables and indexes gathered after load using
$ddlpath${delim}$runstats and $ddlpath${delim}$runstatShort\n";
  }
}
if ( $loadconfigfile ne "NULL" )
{
  print " Database Configuration parameters for LOAD taken from
$ddlpath${delim}$loadconfigfile\n";
}
if ( $loadDBMconfig ne "NULL" )
{
  print " Database manager Configuration parameters for LOAD taken
from $ddlpath${delim}$loadDBMconfig\n";
}
if ( $configfile ne "NULL" )
{
  print " Database Configuration parameters taken from
$ddlpath${delim}$configfile\n";
}
else
{
  print " Database Configuration paramters taken from
$ddlpath${delim}dss.dbconfig${sfReal}GB\n";
  $configfile="dss.dbconfig${sfReal}GB";
}
if ( $dbmconfig ne "NULL" )
{
  print " Database Manager Configuration parameters taken from
$ddlpath${delim}$dbmconfig\n";
}
else
{
  print " Database Manager Configuration paramters taken from
$ddlpath${delim}dss.dbmconfig${sfReal}GB\n";
  $configfile="dss.dbmconfig${sfReal}GB";
}
#print " Copy image for load command created in $copydir\n";
if ( $log eq "yes" )
{
  print " Backup files placed in $backupdir\n";
}
else
{
  print " No backup will be taken.\n";
}
print " Log retain set to $log\n";
if ( $logDir eq "NULL" )
{
  print " Log files remain in database path\n";
}
else
{
  print " Log file path set to $logDir\n";
}
if ( $logprimary eq "NULL" )
{
  print " Log Primary left at default\n";
}
else
{
  print " Log Primary set to $logprimary\n";
}
}

```

```

if ( $logsecond eq "NULL" )
{
  print " Log Second left at default\n";
}
else
{
  print " Log second set to $logsecond\n";
}
if ( $logfilsiz eq "NULL" )
{
  print " Logfilsiz left at default\n";
}
else
{
  print " Logfilsiz set to $logfilsiz\n";
}
if (($loadconfigfile eq "") || ($loadconfigfile eq "NULL"))
{
  print " Machine size set to $machine so the following configura-
tion\n";
  print " parameters are used for load, create index and runstats: \n";
  print "   BUFFPAGE = $buffpage \n";
  print "   SORTHEAP = $sortheap \n";
  print "   SHEAPTHRES = $sheapthres\n";
  print "   NUM_IOSERVERS = $ioservers\n";
  print "   NUM_IOCLEANERS = $ioclnrs\n";
  print "   CHNGPGS_THRESH = $chngpgs\n";
  print "   UTIL_HEAP_SZ = $util_heap_sz\n";
  print "   Degree of parallelism (dft_degree and max_querydegree)
set to $smpdegree\n";
  print "   Parameters for load are: temp file   = $ldtemp\n";
  print "                               sort buf   = $sortbuf\n";
  print "                               ld parallelism = $load_parallelism\n";
  if ( $fparse eq "yes" )
  {
    print "                               FASTPARSE used on load\n";
  }
}
if ( $loadscript ne "NULL" )
{
  print " Load commands in $ddlpath${delim}$loadscript\n";
}

print " Degree of parallelism (dft_degree and max_querydegree) set
to $smpdegree\n";
if ( $agentpri ne "NULL" )
{
  print " AGENTPRI set to $agentpri\n";
}
if ( $activate eq "yes" )
{
  print " Database will be activated when build is complete\n";
}
if ( $explainDDL ne "NULL" )
{
  print " EXPLAIN DDL being used from
$ddlpath${delim}$explainDDL\n";
}
else
{
  print " EXPLAIN DDL being used from default sqlib directory\n";
}

print "Sleeping for 15 seconds to give you a chance to reconsider...\n";
sleep 15;

```

```

# don't need separate calls for mln/mpp vs uni since the $all_In will be
# defined appropriately
if ( $platform eq "nt" )
{
  if (($mode eq "uni") || ($mode eq "smp"))
  {
    #spaces required for NT
    $src=&dodb_noconn("db2set DB2OPTIONS=\\" -t -v +c\\", $all_In);
  }
  else
  {
    $src=&dodb_noconn("db2set DB2OPTIONS=\\\\" -t -v
+c\\", $all_In);
  }
}
else
{
  if (($mode eq "uni") || ($mode eq "smp"))
  {
    $src=&dodb_noconn("db2set DB2OPTIONS=\\"-t -v +c\\", $once);
  }
  else
  {
    $src=&dodb_noconn("db2set DB2OPTIONS=\\\\"-t -v +c\\", $once);
  }
}
}

if ( $rc != 0 )
{
  die "failure setting db2 environment variable : DB2OPTIONS
rc=$rc\n";
}

if ( $platform eq "nt" )
{
  $src=&dodb_noconn("db2set DB2NTNOCACHE=ON", $all_In);
}

if ( $ret != 0 )
{
  die "failure setting db2 environment variable : DB2NTNOCACHE\n";
}
# @de980723wlc

# set the db2 env vars for loading, from the
TPCD_LOAD_DB2SET_SCRIPT script
if ( $loadsetScript ne "NULL" )
{
  if ( $platform eq "nt" )
  {
    ##### Mike , th, the- for some reason rah on NT doesn't like run-
ning
    ##### a fully qualified file name. Switch to dir, then run
    ## check CHANGE THIS to have single node and multinode exe-
cution
    if ( ( $mode eq "uni" ) || ( $mode eq "smp" ) )
    {
      system("db2set -r $instance");
      $ret=system("${ddlpath}${delim}$loadsetScript");
      # $ret=system("cd ${ddlpath} $sep $loadsetScript");
    }
    else
    {
      system("rah \\" db2set -r $instance" ");
      $ret=system("rah \\" cd ${ddlpath} & $loadsetScript" ");
    }
  }
  else
  {

```

```

      system("db2set -r $instance");
      $ret=system("${ddlpath}${delim}$loadsetScript");
    }
  }
  if ( $ret != 0 )
  {
    die "failure setting load time db2set parms from $loadsetScript \n";
  }
}
# stopping and starting db2 before we continue
print "Stopping DB2 ... \n";
$rc=system("db2stop");
if ( $rc < 0 )
{
  die "failure during db2stop rc = $rc \n";
}
print "Starting DB2 ... \n";
$rc=system("db2start");
#if ( $rc != 0 )
#{
# die "failure during db2start rc = $rc \n";
#}

# create the database
if ( $buildStage eq "ALL" )
{
  # build from the beginning
  &outtime("**** Starting to create the database");

  &dodb_noconn("db2 \\"create database $dbname on $dbpath collate
using identity with 'TPC-D $sf GB\\", $once);
  # remove the update.pair.num file so when setupDir runs, it doesn't
  # hang waiting for an answer on nt
  &rm("${auditDir}${delim}$dbname.$user.update.pair.num");

  # reset the dbm configuration before we start
  # and drop deadlock event monitor (kwai 20030721)

  &dodb_conn($dbname, "db2 grant connect on database to public
$sep \
  db2 commit $sep \
  db2 set event monitor db2detaildeadlock state 0 $sep \
  db2 commit $sep \
  db2 drop event monitor db2detaildeadlock $sep \
  db2 commit", $once);

  &dodb_noconn("db2 reset database manager configuration", $once);

  # update the log information first
  # set up the log directory before we do any index creation
  if ($logDirScript ne "NULL")
  {
    system ("${ddlpath}${delim}$logDirScript");
  }
  elseif ( $logDir ne "NULL" )
  {
    &dodb_noconn("db2 update database configuration for $dbname
using newlogpath $logDir", $all_In);
  }
  $setLogs=0;
  $setLogString="";
  if ( $logprimary ne "NULL" )
  {
    $setLogString.="db2 update db cfg for $dbname using logprimary
$logprimary";
    $setLogs=1;
  }
  if ( $logsecond ne "NULL" )
  {
    if ( $setLogs != 0 )
    {

```

```

    $setLogString.=" $sep ";
}
$setLogString.="db2 update db cfg for $dbname using logsecond
$logsecond";
$setLogs=1;
}
if ( $logfilsiz ne "NULL" )
{
    if ( $setLogs != 0 )
    {
        $setLogString.=" $sep ";
    }
    $setLogString.="db2 update db cfg for $dbname using logfilsiz
$logfilsiz";
    $setLogs=1;
}
if ( $setLogs != 0 )
{
    &dodb_noconn("$setLogString",$all_in);
}

# setup the load configuration
&outtime("**** Setting LOAD configuration.");
if (($loadconfigfile eq "") || ($loadconfigfile eq "NULL"))
{
    &dodb_noconn("db2 update db cfg for $dbname using buffpage
$buffpage $sep \
    db2 update db cfg for $dbname using sortheap $sortheap $sep
\
    db2 update db cfg for $dbname using num_iocleaners $ioclnrs
$sep \
    db2 update db cfg for $dbname using num_ioservers
$ioservers $sep \
    db2 update db cfg for $dbname using util_heap_sz
$util_heap_sz $sep \
    db2 update db cfg for $dbname using chngpgs_thresh
$chngpgs",
    $all_in);
    &dodb_noconn("db2 update dbm cfg using sheapthres $sheap-
thres",$once);
}
else
{
    &dodb2file_noconn("$ddlpath${delim}$loadconfigfile",$all_in);
    &dodb2file_noconn("$ddlpath${delim}$loadDBMconfig",$once);
}
system(" db2_all \\\|\\|\\| db2 get db cfg for tpcd >
/db2dump/dbcfg_load.## \" ");
&dodb_noconn("db2 terminate",$once);
$rc=system("db2stop");
if ( $rc != 0 )
{
    die "failure during db2stop after resetting for load config rc = $rc
\n";
}
$rc=system("db2start");
if ( $rc != 0 )
{
    die "failure during db2start rc = $rc \n";
}
} # end of "CREATE DATABASE" phase
if (( $buildStage eq "ALL" ) || ( $buildStage eq "CRTTBSP" ) ||
( $buildStage eq "LOAD" ) ||
( $buildStage eq "INDEX" ) && ( $earlyindex eq "yes" ))
{
    # create the nodegroups is there is a file specified
    if ( $nodegroupdef ne "NULL" )
    {
        #run the create bufferpool ddl
        &outtime("**** Creating the nodegroups");

```

```

        &dodb2file($dbname,"$ddlpath${delim}$nodegroupdef",$once);
    }
    # create the explain tables - these should go into userspace1 since
no
# other tablespaces exist
if ( $explainDDL ne "NULL" )
{
    $explnPathFile="$ddlpath${delim}$explainDDL";
}
else
{
    if ( $platform eq "ptx" )
    {
        $home=$ENV{"HOME"};
        $sqlpath="$home${delim}sqllib";
    }
    if ( $platform ne "nt" )
    {
        $sqlpath="$delimsqllib";
    }
    else
    {
        $sqlpath=$ENV{"DB2PATH"};
    }
    $explnPathFile="$sqlpath${delim}misc${delim}EXPLAIN.DDL";
}

if ( $buffpooldef ne "NULL" )
{
    #run the create bufferpool ddl
    &outtime("**** Creating the bufferpools");
    &dodb2file($dbname,"$ddlpath${delim}$buffpooldef",$once);
}

# create the tablespaces
&outtime("**** Ready to start creating the tablespaces");
&dodb2file($dbname,"$ddlpath${delim}$tbspddl",$once);
# if we are in audit mode, then we must create the the tablespaces
and
# tables for the update functions and we must generate the data for
the
# update functions before we start timing the load. (All activity
# on the database after the table creation is started and before the
performance
# tests are run must be included in load time
# NOTE: we do not have to do this if we are building the qualification
database
&outtime("**** Start of audited Load Time - starting to create tables");

# create/populate the staging tables
if ( $stagingTbl ne "NULL" )
{
    # staging tables must be created for both test and qualification da-
tabase
# but they do not need to be populated for the qualification data-
base
&dodb2file($dbname,"$ddlpath${delim}$stagingTbl",$once);
if ( $qual ne "QUAL" )
{
    if ( $preloadSampleUF ne "NULL" )
    {
        # preload the sample UF data for statistics gathering
        $rc = system ("$ddlpath${delim}$preloadSampleUF");
    }
    if ( $deleteSampleUF ne "NULL" )
    {
        # delete the sample rows now that stats have been gathered

&dodb2file($dbname,"$ddlpath${delim}$deleteSampleUF",$once);

```

```

    }
  }
}
&dodb2file($dbname,"$ddlpath${delim}$ddl", $once);

# update the locksize on the non-updated tables to be table level
locking
# update the tables for appendmode

if ($appendOn eq "yes"){
  &dodb_conn($dbname,
    "db2 alter table tpcd.nation locksize table $sep \
    db2 alter table tpcd.region locksize table $sep \
    db2 alter table tpcd.customer locksize table $sep \
    db2 alter table tpcd.supplier locksize table $sep \
    db2 alter table tpcd.part locksize table $sep \
    db2 alter table tpcd.partsupp locksize table $sep \
    db2 alter table tpcd.lineitem append on $sep \
    db2 alter table tpcd.orders append on",
    $once);
}
else{
  &dodb_conn($dbname,
    "db2 alter table tpcd.nation locksize table $sep \
    db2 alter table tpcd.region locksize table $sep \
    db2 alter table tpcd.customer locksize table $sep \
    db2 alter table tpcd.supplier locksize table $sep \
    db2 alter table tpcd.part locksize table $sep \
    db2 alter table tpcd.partsupp locksize table ",
    $once);
}

if ( $mode eq "mpp" )
{
  #need parallel specific
  print "need to figure parallel specific creation of tmp\n";
}
mkdir("${delim}tmp${delim}$instance",0777);
} # end of "CREATE TABLESPACE and TABLES" phase
if (( $buildStage eq "ALL" ) || ( $buildStage eq "CRTTBSP" ) ||
( $buildStage eq "LOAD" ) ||
(( $buildStage eq "INDEX" ) && ( $earlyindex eq "yes" )))
{
  # do the load stage of the build, or if early index is on do
  # the index creation also
  # setup the load configuration
  if ( $buildStage ne "ALL" )
  { # we're restarting a build so reapply the load config
    &outtime("**** Setting LOAD configuration.");
    if (( $loadconfigfile eq "" ) || ( $loadconfigfile eq "NULL" ))
    {
      &dodb_noconn("db2 update db cfg for $dbname using buffpage
$buftp $sep \
      db2 update db cfg for $dbname using sortheap $sortheap $sep
\
      db2 update db cfg for $dbname using num_iocleaners $ioclnrs
$sep \
      db2 update db cfg for $dbname using num_ioservers
$ioservers $sep \
      db2 update db cfg for $dbname using util_heap_sz
$util_heap_sz $sep \
      db2 update db cfg for $dbname using chngpgs_thresh
$chngpgs",
      $all_in);
      &dodb_noconn("db2 update dbm cfg using sheapthres $sheap-
thres", $once);
    }
    else
    {
      &dodb2file_noconn("${ddlpath}${delim}$loadconfigfile", $all_in);

```

```

      &dodb2file_noconn("${ddlpath}${delim}$loadDBMconfig", $once);
    }
  }
  &dodb_noconn("db2 terminate", $once);
  $rc=system("db2stop");
  if ( $rc != 0 )
  {
    die "failure during db2stop after resetting for load config rc = $rc
\n";
  }
  $rc=system("db2start");
  if ( $rc != 0 )
  {
    die "failure during db2start rc = $rc \n";
  }
}

# if earlyindex requested, create indexes
if ( $earlyindex eq "yes" )
{
  &outtime("**** Starting to create indexes");
  &dodb2file($dbname,"$ddlpath${delim}$indexddl", $once);

  &outtime("**** Create index completed");
}

# start the dbgen and load.....call the specific mode for loading
(uni,smp,mIn)
if (( $mode eq "uni" ) || ( $mode eq "smp" ))
{
  &outtime("**** Starting the load");
  # call the appropriate dbgen/load for uni/smp
  if (( $loadscript eq "NULL" ) || ( $loadscript eq "" ))
  {
    $rc = system("perl genloaduni $qual");
    if ( $rc != 0 )
    {
      die "genloaduni failed rc = $rc\n";
    }
  }
  else
  {
    &dodb2file_noconn("${ddlpath}${delim}$loadscript", $once);
  }
}
elseif (( $mode eq "mIn" ) || ( $mode eq "mpp" ))
{
  &outtime("**** Starting the load");
  # call the appropriate dbgen/split/(sort)/load for mIn/mpp

  if (( $loadscript eq "NULL" ) || ( $loadscript eq "" ))
  {
    $rc = system("perl genloadmpp $qual");
    if ( $rc != 0 )
    {
      die "genloadmpp failed rc = $rc\n";
    }
  }
  else
  {
    # $rc = &dodb2file_noconn("${ddlpath}${delim}$loadscript $sf");
    $rc = system("${ddlpath}${delim}$loadscript $sf");
  }

  if ( $rc != 0 )
  {
    die "doload for $dbname failed rc = $rc. Script is
$ddlpath${delim}$loadscript\n";
  }
}
}

```

```

else
{
die "TPCD_MODE not set to one of uni, smp, mln or mpp\n";
}

&outtime("**** Load complete");

# verify that the audit directory exists
$filename="$auditDir";
if (-e $filename)
{
# set up the $auditDir/$dbname.$user.update.pair.num file
# to start at update pair 1
$filename="$auditDir${delim}$dbname.$user.update.pair.num";
}
else
{
mkdir ("$auditDir", 0775) || die "cannot mkdir $auditDir";
}
print "setting update pair num to 1\n";
system("echo 1 > $filename");
} # end all and load stage (and create index if early index was speci-
fied

if (( $buildStage eq "ALL" ) || ( $buildStage eq "CRTTBSP" ) ||
( $buildStage eq "LOAD" ) ||
( $buildStage eq "INDEX" ))
{
if ( $buildStage eq "INDEX")
{ # we're restarting a build so reapply the load config
&outtime("**** Setting LOAD configuration.");
if (($loadconfigfile eq "") || ($loadconfigfile eq "NULL"))
{
&dodb_noconn("db2 update db cfg for $dbname using buffpage
$buffpage $sep \
db2 update db cfg for $dbname using sorheap $sorheap $sep \
db2 update db cfg for $dbname using num_iocleaners $ioclnrs
$sep \
db2 update db cfg for $dbname using num_ioservers
$ioservers $sep \
db2 update db cfg for $dbname using util_heap_sz
$util_heap_sz $sep \
db2 update db cfg for $dbname using chngpgs_thresh
$chngpgs",
$all_in);
&dodb_noconn("db2 update dbm cfg using sheapthres $sheap-
thres", $once);
}
else
{
&dodb2file_noconn("$ddlpath${delim}$loadconfigfile", $all_in);
&dodb2file_noconn("$ddlpath${delim}$loadDBMconfig", $once);
}
&dodb_noconn("db2 terminate", $once);
$rc=system("db2stop");
if ( $rc != 0 )
{
die "failure during db2stop after resetting for load config rc = $rc
\n";
}
$rc=system("db2start");
if ( $rc != 0 )
{
die "failure during db2start rc = $rc \n";
}
}
}
}

```

```

# if indexes haven't been created, do so now
if ( $earlyindex ne "yes" )
{
&outtime("**** Create index started");
&dodb2file($dbname, "$ddlpath${delim}$indexddl", $once);

&outtime("**** Create index completed");
}
if ( $extraindex ne "no" )
{
# use this additional file for indexes
&outtime("**** Create index (part 2) started");
&dodb2file($dbname, "$ddlpath${delim}$extraindex", $once);
&outtime("**** Create index (part 2) completed");
}
} # end create/load/index phase of the build

if (( $buildStage eq "ALL" ) || ( $buildStage eq "CRTTBSP" ) ||
( $buildStage eq "LOAD" ) ||
( $buildStage eq "INDEX" ) || ( $buildStage eq "RUNSTATS" ))
{
if ( $buildStage eq "RUNSTATS")
{ # we're restarting a build so reapply the load config
&outtime("**** Setting LOAD configuration.");
if (($loadconfigfile eq "") || ($loadconfigfile eq "NULL"))
{
&dodb_noconn("db2 update db cfg for $dbname using buffpage
$buffpage $sep \
db2 update db cfg for $dbname using sorheap $sorheap $sep \
db2 update db cfg for $dbname using num_iocleaners $ioclnrs
$sep \
db2 update db cfg for $dbname using num_ioservers
$ioservers $sep \
db2 update db cfg for $dbname using util_heap_sz
$util_heap_sz $sep \
db2 update db cfg for $dbname using chngpgs_thresh
$chngpgs",
$all_in);
&dodb_noconn("db2 update dbm cfg using sheapthres $sheap-
thres", $once);
}
else
{
&dodb2file_noconn("$ddlpath${delim}$loadconfigfile", $all_in);
&dodb2file_noconn("$ddlpath${delim}$loadDBMconfig", $once);
}
&dodb_noconn("db2 terminate", $once);
$rc=system("db2stop");
if ( $rc != 0 )
{
die "failure during db2stop after resetting for load config rc = $rc
\n";
}
$rc=system("db2start");
if ( $rc != 0 )
{
die "failure during db2start rc = $rc \n";
}
}
}
# if statistics not gathered on the load, run runstats (we have to run
the
# stats at the same time as the index creation whether it be both dur-
ing load,
# or after load)
# We need to run the runstats as well if we have specified an extra
index file
# for "after load" indexes

```

```

if (( $loadstats eq "no" ) || ( $searlyindex eq "no" ) || ( $extraindex ne
"no" ))
{
# if loadstats not gathered, then index stats not gathered either.
&outtime("**** Runstats started");

if ( $runstatShort ne "NULL" )
{
# we've specified a second runstats file...This runstats file
should do
# runstats for all table except lineitem. The lineitem runstats
command
# should be left in the main runstats file.
if ( $platform eq "aix" || $platform eq "sun" || $platform eq "ptx" )
{
print "runstats from $ddlpath${delim}$runstatShort running
now\n";
$rc = system("db2 -tvf \"$ddlpath${delim}$runstatShort\" >
\"$auditDir${delim}tools${delim}runstatShort.out\" & ");
print "rc from runstatshort=$rc\n";
}
elseif ( $platform eq "nt" )
{
system("start db2 -tvf $ddlpath${delim}$runstatShort");
}
else
{
print "Don't know how to start in background on $platform
platform\n";
print "therefore running runstats serially\n";
}
&dodb2file($dbname, "$ddlpath${delim}$runstatShort", $once);
}
}
# run the full runstats, or the remainder of what wasn't put into the
short
# runstats file. You should be sure that this runstats will take
longer
# than the short runstats that is running in the background, other-
wise
# setting the config will happen before this is done.
&dodb2file($dbname, "$ddlpath${delim}$runstats", $once);
&outtime("**** Runstats completed");
}
} # end build phase all/load/index/runstats

# add the RI
if ( $addRI ne "NULL" )
{
&outtime("**** Adding RI constraints started");
&dodb2file($dbname, "$ddlpath${delim}$addRI", $once);
&outtime("**** Adding RI constraints completed");
}

#add the AST if it has been requested
if ( $astFile ne "NULL" )
{
&outtime("**** Adding AST started");
&dodb2file($dbname, "$ddlpath${delim}$astFile", $once);
&outtime("**** Adding AST completed");
}

# check tbspc info
&dodb_conn($dbname, "db2 list tablespaces show detail", $once);

# set the configuration
&outtime("**** Set Configuration started");
&dodb2file_noconn("${ddlpath}${delim}$configfile", $all_in);
&dodb2file_noconn("${ddlpath}${delim}$dbmconfig", $once);

```

```

system(" db2_all \\\\\" db2 get db cfg for tpcd >
/db2dump/dbcfg_run.## \\\\" );

if ( $buffpooldef_run ne "NULL" )
{
# set run bufferpools kmw-ironwood
&outtime("**** Altering the bufferpools");
&dodb2file($dbname, "$ddlpath${delim}$buffpooldef_run", $once);
}

if ( $agentpri ne "NULL" )
{
&dodb_noconn("db2 update dbm cfg using AGENTPRI $agent-
pri", $once);
}

# set the db2 environment variables for running the benchmark
if ( $setScript ne "NULL" )
{
if ( $platform eq "aix" || $platform eq "sun" || $platform eq "ptx" )
{
system("db2set -r $instance");
$setScript=system("${ddlpath}${delim}$setScript");
}
elseif ( $platform eq "nt" )
{
if (($mode eq "uni" ) || ($mode eq "smp" ))
{
system("db2set -r $instance");
$set = system("perl ${ddlpath}${delim}$setScript");
}
else
{
system(" rah \\\\" db2set -r $instance" );
$set = system(" rah \\\\" cd ${ddlpath} & $setScript \\\\" );
}
}
if ( $set != 0 )
{
die "failure setting runtime db2set parms from $setScript \n";
}
}
# if logging is enabled, we must take a backup of the database
if ( $log eq "yes" )
{
&dodb_noconn("db2 update database configuration for $dbname us-
ing LOGRETAIN yes", $all_in);
print "\n NOTE: DO NOT RESET THE DATABASE
CONFIGURATION or you will lose logretain\n";
# force a connection to the database on all nodes to ensure
LOGRETAIN is
# set in effect.
# An error message will print to screen if the logretain is set properly
# i.e. SQL116N A connection to or activation of database <database
name>
# cannot be made.
# This is expected and the lack of this error message should be
seen as an
# error in the database build.
&dodb_conn($dbname, "db2 \\\\"select count(*) from
tpcd.region\\\\"", $all_in);

if ( $qual eq "QUAL" )
{
&outtime("**** Starting the backup");

if (( $mode eq "mln" ) || ( $mode eq "mpp" ))
{
# must back up catalog node first...assume node 00

```

```

    $rc=system("db2_all \})<<+000< db2 \"backup database
$dbname to $backupdir without prompting\" ' ');
    if ( $rc != 0 )
    {
        die "backup of catalog node failed rc = $rc\n";
    }
    # back up remaining nodes
    $rc=system("db2_all \})<<-000< db2 backup database
$dbname to $backupdir without prompting\" ' ');
    if ( $rc != 0 )
    {
        die "backup of remaining nodes failed rc = $rc\n";
    }
    }
    else
    {
        &dodb_noconn("db2 backup database $dbname to $backup-
dir", $once);
    }
    &outtime("**** Finished the backup");
}
else
{
    # This is the test database. Clause 3.1.4 states that "the test
sponsor is
# not required to make or have backup copies of the test data-
base; however
# all other mechanisms that guarantee durability of the qualifica-
tion
# database must be enabled in the same way for the test data-
base".
# According to this clause we do need to keep the backup of the
database.
&dodb_noconn("db2dart $dbname /CHST /WHAT DBBP
OFF", $all_in);
}
}

# stop and restart database to get config parms recognized
$rc=system("db2stop");
if ( $rc != 0 )
{
    die "failure during db2stop rc = $rc \n";
}
$rc=system("db2start");
if ( $rc != 0 )
{
    die "failure during db2start rc = $rc \n";
}

&outtime("**** Set Configuration completed");
&outtime("**** End of audited Load Time");

#create generated seeds
if ( $genSeed ne "no" )
{
    $rc = system("perl createmseedme.pl 1000");
    if ( $rc != 0 )
    {
        warn "createmseedme failed\n";
    }
}

$rc = system("perl buildtpcdbatch $qual");
if ( $rc != 0 )
{
    die "buildtpcdbatch failed rc=$rc\n";
}

```

```

if ( $RealAudit eq "yes" )
{
    # if we are in real audit mode then we have to do a number of things
    # set up the audit directory structure and the run directory structure
    # so that once we have completed the buildtpcd, we are ready to
run.
    # first remove any old "update pair number" file so we won't get
prompted
    # doing setupDir
    &rm("$auditDir${delim}tools${delim}tpcd.runsetup");
    system("perl setupRun");
    # before we stop the database for the final time
    # if we are in the real audit mode then run dbtables and dbcheck be-
fore
    # we print out the final notice that we are ready to run the perform-
ance tests
    # if we are building the qualification database then we will bind to
both
    # the dbname database and the qualification database
    if ( $qual eq "QUAL" )
    {
        $verifyType="q";
    }
    else
    {
        $verifyType="t";
    }
    system("perl tablesdb $verifyType");

&dodb2file($dbname, "$auditDir${delim}tools${delim}first10rows.sql", $o-
nce);
}
# stop, restart and activate the database, if necessary

#Create Catalog info
$rc = system("perl catinfo.pl b");

if ( $rc != 0 )
{
    warn "catinfo failed!!! rc = $rc\n";
}

$rc=system("db2stop");
if ( $rc != 0 )
{
    die "failure during db2stop rc = $rc \n";
}

&outtime("**** Ready to run the performance tests once the dbm has
restarted");

if ( $RealAudit ne "yes" )
{
    # if we are not in a real audit, then we can restart the database man-
ager
    # if we are in a real audit, then we don't want to do this until the
# power test starts
    $rc=system("db2start");
    if ( $rc != 0 )
    {
        die "failure during db2start rc = $rc \n";
    }
    if ( $activate eq "yes" )
    {
        &dodb_noconn("activate database $dbname", $once);
    }
}

# finished creating the database
&outtime("**** Finished creating the database");

```

Appendix - C Query Text and Output

C.1 Qualification Query Output

Query 1

-- Query 01 - Var_0 Rev_01 - Pricing Summary Report Query

Tag: Q1 Stream: -1 Sequence number: 17

```
select
l_returnflag,
l_linestatus,
sum(l_quantity) as sum_qty,
sum(l_extendedprice) as sum_base_price,
sum(l_extendedprice * (1 - l_discount)) as sum_disc_price,
sum(l_extendedprice * (1 - l_discount) * (1 + l_tax)) as sum_charge,
avg(l_quantity) as avg_qty,
avg(l_extendedprice) as avg_price,
avg(l_discount) as avg_disc,
count_big(*) as count_order
from
tpcd.lineitem
where
l_shipdate <= date ('1998-12-01') - 90 day
group by
l_returnflag,
l_linestatus
order by
l_returnflag,
l_linestatus
```

L_RETURNFLAG	L_LINESTATUS	SUM_QTY	SUM_BASE_PRICE	SUM_DISC_PRICE	SUM_CHARGE
AVG_QTY	AVG_PRICE	AVG_DISC	COUNT_ORDER		

A	F	37734107.000	56586554400.730		
53758257134.870		55909065222.828	25.522		
38273.130		0.050	1478493.		
N	F	991417.000	1487504710.380		
1413082168.054		1469649223.194	25.516		
38284.468		0.050	38854.		
N	O	74476040.000	111701729697.740		
106118230307.605		110367043872.497	25.502		
38249.118		0.050	2920374.		
R	F	37719753.000	56568041380.900		
53741292684.604		55889619119.832	25.506		
38250.855		0.050	1478870.		

Number of rows retrieved is: 4

Query 2

-- Query 02 - Var_0 Rev_02 - Minimum Cost Supplier Query

Tag: Q2 Stream: -1 Sequence number: 2

```
select
s_acctbal,
s_name,
n_name,
p_partkey,
p_mfgr,
```

```
s_address,
s_phone,
s_comment
from
tpcd.part,
tpcd.supplier,
tpcd.partsupp,
tpcd.nation,
tpcd.region
where
p_partkey = ps_partkey
and s_suppkey = ps_suppkey
and p_size = 15
and p_type like '%BRASS'
and s_nationkey = n_nationkey
and n_regionkey = r_regionkey
and r_name = 'EUROPE'
and ps_supplycost = (
select
min(ps_supplycost)
from
tpcd.partsupp,
tpcd.supplier,
tpcd.nation,
tpcd.region
where
p_partkey = ps_partkey
and s_suppkey = ps_suppkey
and s_nationkey = n_nationkey
and n_regionkey = r_regionkey
and r_name = 'EUROPE'
)
order by
s_acctbal desc,
n_name,
s_name,
p_partkey
fetch first 100 rows only
```

S_ACCTBAL	S_NAME	N_NAME
P_PARTKEY	P_MFGR	S_ADDRESS
S_PHONE	S_COMMENT	

9938.530	Supplier#000005359	UNITED KINGDOM
185358	Manufacturer#4	QKuHYh,vZGiwu2FWEJoLDx04
33-429-790-6131	blithely silent pinto beans are furiously. slyly final deposits across	
9937.840	Supplier#000005969	ROMANIA
108438	Manufacturer#1	
ANDENSOSmk,miq23Xfb5RWt6dvUcvt6Qa		29-520-692-3537
carefully slow deposits use furiously. slyly ironic platelets above the ironic		
9936.220	Supplier#000005250	UNITED KINGDOM
249	Manufacturer#4	B3rqp0xbSEim4Mpy2RH J
33-320-228-2957	blithely special packages are. stealthily express deposits across the closely final instructi	
9923.770	Supplier#000002324	GERMANY
29821	Manufacturer#4	y3OD9UywSTok
779-299-1839	quickly express packages breach quiet pinto beans. requ	17-
9871.220	Supplier#000006373	GERMANY
43868	Manufacturer#5	J8fcXWstqM
813-485-8637	never silent deposits integrate furiously blit	17-
9870.780	Supplier#000001286	GERMANY
81285	Manufacturer#2	
YKA,E2fjiVd7eUrzp2Ef8j1QxGo2DFnosaTEH		17-516-924-4574
final theodolites cajole slyly special,		

9870.780 Supplier#000001286 GERMANY
181285 Manufacturer#4
YKA,E2fjiVd7eUrzp2Ef8j1QxGo2DFnosaTEH 17-516-924-4574
final theodolites cajole slyly special,
9852.520 Supplier#000008973 RUSSIA
18972 Manufacturer#2 t5L67YdBYyH6o,Vz24jpDyQ9
32-188-594-7038 quickly regular instructions wake-- carefully unusual
braids into the expres
9847.830 Supplier#000008097 RUSSIA
130557 Manufacturer#2 xMe97bpE69NzdwLoX
32-375-640-3593 slyly regular dependencies sleep slyly furiously
express dep
9847.570 Supplier#000006345 FRANCE
86344 Manufacturer#1
VSt3rzK3qG698u6ld8HhOByvrTcSTsvQIDQDag 16-886-766-7945
silent pinto beans should have to snooze carefully along the final
reques
9847.570 Supplier#000006345 FRANCE
173827 Manufacturer#2
VSt3rzK3qG698u6ld8HhOByvrTcSTsvQIDQDag 16-886-766-7945
silent pinto beans should have to snooze carefully along the final
reques
9836.930 Supplier#000007342 RUSSIA
4841 Manufacturer#4 JOIK7C1,7xrEZSSow 32-
399-414-5385 final accounts haggle. bold accounts are furiously
dugouts. furiously silent asymptotes are slyly
9817.100 Supplier#000002352 RUSSIA
124815 Manufacturer#2 4LfoHUZjgEjEbAKw
TgdKcgOc4D4uCYw 32-551-831-1437 blithely pending
packages across the ironic accounts grow slyly after the furiously
9817.100 Supplier#000002352 RUSSIA
152351 Manufacturer#3 4LfoHUZjgEjEbAKw
TgdKcgOc4D4uCYw 32-551-831-1437 blithely pending
packages across the ironic accounts grow slyly after the furiously
9739.860 Supplier#000003384 FRANCE
138357 Manufacturer#2 o,Z3v4POifeV k9U1b 6J1ucX,l
16-494-913-5925 slyly ironic theodolites hag
9721.950 Supplier#000008757 UNITED KINGDOM
156241 Manufacturer#3 Atg6GnM4dT2 33-
821-407-2995 ironic, even dolphins above the furiously ironic foxes
sleep slyly around the caref
9681.330 Supplier#000008406 RUSSIA
78405 Manufacturer#1 ,qUuXcftUI 32-139-
873-8571 furiously even deposits affix thinly special theodolites. furio
9643.550 Supplier#000005148 ROMANIA
107617 Manufacturer#1 kT4ciVFslx9z4s79p Js825
29-252-617-4850 doggedly even ideas boost furiously against the
furiously express
9624.820 Supplier#000001816 FRANCE
34306 Manufacturer#3
e7vab91vLJpWxxZnewmnDBpDmxYHrb 16-392-237-6726
blithely regular accounts cajole furiously. regular
9624.780 Supplier#000009658 ROMANIA
189657 Manufacturer#1 oE9uBgEfSS4oplcepXyAYM,x
29-748-876-2014 regular deposits haggle. furiously express asympto
9612.940 Supplier#000003228 ROMANIA
120715 Manufacturer#2
KDdpNKN3cWu7ZSrbdqp7AfSLxx,qWB 29-325-784-8187
carefully pending accounts serve. furiously close deposits boost slyly. q
9612.940 Supplier#000003228 ROMANIA
198189 Manufacturer#4
KDdpNKN3cWu7ZSrbdqp7AfSLxx,qWB 29-325-784-8187
carefully pending accounts serve. furiously close deposits boost slyly. q
9571.830 Supplier#000004305 ROMANIA
179270 Manufacturer#2 qNHZ7WmCzygwMPRDO9Ps
29-973-481-1831 furiously final deposits
9558.100 Supplier#000003532 UNITED KINGDOM
88515 Manufacturer#4
EOeuiiOn21OVpTIGguuffDFsbN1p0lhpXHp 33-152-301-2164
daring, sly accounts breach about th

9492.790 Supplier#000005975 GERMANY
25974 Manufacturer#5 S6mliCTx82z7IV 17-
992-579-4839 always pending packages boost slyly.
9461.050 Supplier#000002536 UNITED KINGDOM
20033 Manufacturer#1 8mmGbyzaU
7ZS2wJumTibypncu9pNkDc4FYA 33-556-973-5522 even foxes are
quickly furiously express requests. packages
9453.010 Supplier#000000802 ROMANIA
175767 Manufacturer#1 ,6HYXb4uaHITmtMBj4Ak57Pd
29-342-882-6463 final, regular packages across the slowly regular
packag
9408.650 Supplier#000007772 UNITED KINGDOM
117771 Manufacturer#4 AiC5YAH,gu0i7 33-
152-491-1126 blithely final ideas sleep carefully. requests are
9359.610 Supplier#000004856 ROMANIA
62349 Manufacturer#5 HYgcF3Jb yh1 29-
334-870-9731 carefully unusual packages sleep carefully even ideas.
dogged accoun
9357.450 Supplier#000006188 UNITED KINGDOM
138648 Manufacturer#1 g801,ssP8wpTk4Hm
33-583-607-1633 carefully regular deposits wake carefully furiously
even i
9352.040 Supplier#000003439 GERMANY
170921 Manufacturer#4 qYPDgoiBGhCYxjgC
17-128-996-4650 fluffily regular pinto beans wake. unusual, final ideas
c
9312.970 Supplier#000007807 RUSSIA
90279 Manufacturer#5 oGYMPck9XHGB2PBfKRnHA
32-673-872-5854 unusual asymptotes above the
9312.970 Supplier#000007807 RUSSIA
100276 Manufacturer#5 oGYMPck9XHGB2PBfKRnHA
32-673-872-5854 unusual asymptotes above the
9280.270 Supplier#000007194 ROMANIA
47193 Manufacturer#3 zhRUQkBSrFYxIAXTflnj vyGRQjeK
29-318-454-2133 slyly ironic requests despite the unusual ins
9274.800 Supplier#000008854 RUSSIA
76346 Manufacturer#3 1xhLoOUM7I3mZ1mKnerw
OSqdbb4QbGa 32-524-148-5221 ruthlessly ironic instructions
along the regular, furious requests integrate car
9249.350 Supplier#000003973 FRANCE
26466 Manufacturer#1
d18GiDsL6Wm2IsGXM,RZf1jCsgZAOjNYVThTRP4 16-722-866-1658
quickly ironic sauternes use b
9249.350 Supplier#000003973 FRANCE
33972 Manufacturer#1
d18GiDsL6Wm2IsGXM,RZf1jCsgZAOjNYVThTRP4 16-722-866-1658
quickly ironic sauternes use b
9208.700 Supplier#000007769 ROMANIA
40256 Manufacturer#5 rsimdze 5o9P Ht7xS 29-
964-424-9649 furiously ruthless epitaphs among the furiously regular
accounts use slowly fluffily ev
9201.470 Supplier#000009690 UNITED KINGDOM
67183 Manufacturer#5 CB BnUTImi5zdeEI7R7
33-121-267-9529 blithely unusual accounts integrate slyly. platelets
9192.100 Supplier#000000115 UNITED KINGDOM
85098 Manufacturer#3 nJ 2t0f7Ve,wL1,6WzGBJLNBUCKIsV
33-597-248-1220 slyly bold pinto beans boost across the furiously
regular packages. carefully regu
9189.980 Supplier#000001226 GERMANY
21225 Manufacturer#4 qsLcQsVlyZfuXlpjz 17-
725-903-1381 final, express instruction
9128.970 Supplier#000004311 RUSSIA
146768 Manufacturer#5 I8JnXd7NSJRs594RxsRR0
32-155-440-7120 regular pinto beans sleep ca
9104.830 Supplier#000008520 GERMANY
150974 Manufacturer#4 RqRVDgD0ER J9 b41vR2,3
17-728-804-1793 deposits sleep carefully e
9101.000 Supplier#000005791 ROMANIA
128254 Manufacturer#5 zub2zCV,jhHPPQqi,P2INajE1zl
n66cOEoXFG 29-549-251-5384 carefully ironic packages after the

9094.570 Supplier#000004582 RUSSIA
 39575 Manufacturer#1 WBOxkCSG3r,mnQ
 n,h9Vlxjr9ARHFvKqMDf 32-587-577-1351 asymptotes above the
 slyly even requests haggle furiously about the regular accounts
 8996.870 Supplier#000004702 FRANCE
 102191 Manufacturer#5 8XVcQK23akp 16-
 811-269-8946 stealthy requests haggle c
 8996.140 Supplier#00000814 ROMANIA
 139813 Manufacturer#2
 af0O5pg83IPU4IDVmEylXZVqYZQzSDIYLAmR 29-995-571-8781
 ironic theodolites are evenly unusual requests-- pending pinto beans
 across the in
 8968.420 Supplier#000010000 ROMANIA
 119999 Manufacturer#5 aTGLEusCiL4F
 PDBdv665XBjHPyCOB0i 29-578-432-2146 furiously final ideas
 believe furiously. furiously final ideas
 8936.820 Supplier#000007043 UNITED KINGDOM
 109512 Manufacturer#1
 FVajceZlnZdbJE6Z9XsRUxrUEpiwHDrOXi,1Rz 33-784-177-8208
 furiously regular excuses wake after the blithely special pinto beans?
 even instructions sl
 8929.420 Supplier#000008770 FRANCE
 173735 Manufacturer#4 R7cG26TtXrHAP9 HckhfRi
 16-242-746-9248 final accounts sleep furiously. blithely ironic foxes
 wake boldly across the furiously s
 8920.590 Supplier#000003967 ROMANIA
 26460 Manufacturer#1 eHoAXe62SY9 29-
 194-731-3944 quickly even requests should have to affix blithely-- fur
 8920.590 Supplier#000003967 ROMANIA
 173966 Manufacturer#2 eHoAXe62SY9 29-
 194-731-3944 quickly even requests should have to affix blithely-- fur
 8913.960 Supplier#000004603 UNITED KINGDOM
 137063 Manufacturer#2
 OUzlvMUR7n,utLxmPNeYKsf3T24OXskxB5 33-789-255-7342
 slyly ironic packages detect furious accounts. ironic de
 8877.820 Supplier#000007967 FRANCE
 167966 Manufacturer#5 A3pi1BARM4nx6R,qrwFoRPU
 16-442-147-9345 final deposits after the silent deposits ha
 8862.240 Supplier#000003323 ROMANIA
 73322 Manufacturer#3 W9 IYcsC9FwBqk3ItL
 29-736-951-3710 unusual, pending theodolites integrate furiously slyly
 even pinto beans. unusual sheaves sleep befor
 8841.590 Supplier#000005750 ROMANIA
 100729 Manufacturer#5
 Erx3lAgu0g62iaHF9x50uMH4EgeN9hEG 29-344-502-5481
 excuses after the blithely regular packages mold carefully deposits.
 regular a
 8781.710 Supplier#000003121 ROMANIA
 13120 Manufacturer#5 wNqTogx238ZYCamFb,50v,bj
 4lbNFW9Bvw1xP 29-707-291-5144 packages are quickly after the
 final, even packages. furiously regular
 8754.240 Supplier#000009407 UNITED KINGDOM
 179406 Manufacturer#4 CHRCbkaWcf5B
 33-903-970-9604 regular dependencies haggle across the carefully
 bold
 8691.060 Supplier#000004429 UNITED KINGDOM
 126892 Manufacturer#2 k,BQms5UhoAF1B2Asi,fLib
 33-964-337-5038 quickly special foxes against the furiously silent
 platelets wake quickly after t
 8655.990 Supplier#000006330 RUSSIA
 193810 Manufacturer#2 UozlaENrOytKe2w6CelEWFwN
 iO3S8Rae7Ou 32-561-198-3705 blithely even packages alongside
 8638.360 Supplier#000002920 RUSSIA
 75398 Manufacturer#1 Je2a8bszf3L 32-
 122-621-7549 express deposits wake. furiously silent requests wake
 carefully silent instru
 8638.360 Supplier#000002920 RUSSIA
 170402 Manufacturer#3 Je2a8bszf3L 32-
 122-621-7549 express deposits wake. furiously silent requests wake
 carefully silent instru

8607.690 Supplier#000006003 UNITED KINGDOM
 76002 Manufacturer#2
 EH9wADcEiuenMONR08zDwMidw,52Y2RyILeIA 33-416-807-5206
 always special foxes wake slyly bold, ironic accounts. ironic
 instructions affix carefull
 8569.520 Supplier#000005936 RUSSIA
 5935 Manufacturer#5 jXaNZ6vwnEWJ2ksLZJpjtgt0bY2a3AU
 32-644-251-7916 packages sleep furiously. special requests about the
 fluffily even accounts detect
 8564.120 Supplier#000000033 GERMANY
 110032 Manufacturer#1
 gfeKpYw3400L0SDyWXA6Ya1Qmq1w6YB9f3R 17-138-897-9374
 ironic instructions are. special pearls above
 8553.820 Supplier#000003979 ROMANIA
 143978 Manufacturer#4 BfmVhCAnCMY3jzpjUmY4CNWs9
 HzpdQR7INJU 29-124-646-4897 express, ironic pinto beans cajole
 around the express, even packages. qu
 8517.230 Supplier#000009529 RUSSIA
 37025 Manufacturer#5 e44R8o7JAIS9iMcR 32-
 565-297-8775 furiously silent requests cajole furiously furiously ironic
 foxes. slyly express p
 8517.230 Supplier#000009529 RUSSIA
 59528 Manufacturer#2 e44R8o7JAIS9iMcR 32-
 565-297-8775 furiously silent requests cajole furiously furiously ironic
 foxes. slyly express p
 8503.700 Supplier#000006830 RUSSIA
 44325 Manufacturer#4 BC4WFCYRUZyalgchU 4S
 32-147-878-5069 quickly regular excuses detect evenly around
 8457.090 Supplier#000009456 UNITED KINGDOM
 19455 Manufacturer#1 7SBhZs8gP1cJt0Qf433YBk
 33-858-440-4349 carefully final accounts sleep blithely special foxes.
 slyly regular pinto beans alon
 8441.400 Supplier#000003817 FRANCE
 141302 Manufacturer#2 hU3fz3xL78 16-
 339-356-5115 blithely blithe ideas are
 8432.890 Supplier#000003990 RUSSIA
 191470 Manufacturer#1
 wehBBp1RQbfxAYDASS75MsywmsKHRVdkrvNe6m 32-839-509-
 9301 final requests along the blithely ironic packages kindle against
 the carefully fina
 8431.400 Supplier#000002675 ROMANIA
 5174 Manufacturer#1
 HJFStOu9R5NGPOegKhgbzBdyvrG2yh8w 29-474-643-1443
 express, final deposits cajole carefully. stealthily unusual requests
 8407.040 Supplier#000005406 RUSSIA
 162889 Manufacturer#4 j7 gYF5RW8DC5UjKc
 32-626-152-4621 quickly final sheaves boost. car
 8386.080 Supplier#000008518 FRANCE
 36014 Manufacturer#3
 2jqzqqAVe9crMVGP,n9nTsQXulNTUYoJjEdcqWV 16-618-780-7481
 slyly ironic theodolites are slyly. dogged, pendin
 8376.520 Supplier#000005306 UNITED KINGDOM
 190267 Manufacturer#5 9t8Y8
 QqSIsOADPt6NLdk,TP5zyRx41oBUlgoGc9 33-632-514-7931
 furiously even instructions integrate during the furiously regular re
 8348.740 Supplier#000008851 FRANCE
 66344 Manufacturer#4 nWxi7GwEbjhw1 16-
 796-240-2472 ironic instructions nag slyly against the slyly even
 theodolites. requests alongside of
 8338.580 Supplier#000007269 FRANCE
 17268 Manufacturer#4 ZwhJSwABUoiB04,3
 16-267-277-4365 ruthlessly regular asymptotes a
 8328.460 Supplier#000001744 ROMANIA
 69237 Manufacturer#5 oLo3fV64q2,FKHa3p,qHnS7Yzv,ps8
 29-330-728-5873 blithely silent excuses are slyly above the furiously
 even courts
 8307.930 Supplier#000003142 GERMANY
 18139 Manufacturer#1 dqblvV8dCNAorGIJ 17-
 595-447-6026 theodolites sleep blithely carefully regular warhorses.
 slyly regular ins

8231.610 Supplier#000009558 RUSSIA
 192000 Manufacturer#2 mcdgen,yT1iJDHDS5fV
 32-762-137-5858 slyly regular theodolites sleep fluffy express depos
 8152.610 Supplier#000002731 ROMANIA
 15227 Manufacturer#4 nluXJCuY1tu 29-
 805-463-2030 gifts use. slyly silent ideas are carefully beneath the
 silent instructions. slyly sil
 8109.090 Supplier#000009186 FRANCE
 99185 Manufacturer#1 wgfosrVPexl9pEXWYwaqIBMDYYf
 16-668-570-1402 quickly pending requests are blithely along the
 ironic, final requests; instr
 8102.620 Supplier#000003347 UNITED KINGDOM
 18344 Manufacturer#5 m CtXS2S16i 33-
 454-274-8532 packages grow special orbits. regular theodolites about
 the carefully pe
 8046.070 Supplier#000008780 FRANCE
 191222 Manufacturer#3 AczzuE0UK9osj ,Lx0Jmh
 16-473-215-6395 regular epitaphs integrate slyly.
 8042.090 Supplier#000003245 RUSSIA
 135705 Manufacturer#4
 Dh8lkg39onrbOL4DyTfGw8a9oKUX3d9Y 32-836-132-8872
 carefully regular instructions integrate blithely silent foxes. furiously
 express instructions hagg
 8042.090 Supplier#000003245 RUSSIA
 150729 Manufacturer#1
 Dh8lkg39onrbOL4DyTfGw8a9oKUX3d9Y 32-836-132-8872
 carefully regular instructions integrate blithely silent foxes. furiously
 express instructions hagg
 7992.400 Supplier#000006108 FRANCE
 118574 Manufacturer#1 8tBydnTDwUqfBfFV4I3
 16-974-998-8937 regular pinto beans are after
 7980.650 Supplier#000001288 FRANCE
 13784 Manufacturer#4 zE,7HgVPrCn 16-
 646-464-8247 unusual pinto beans cajole furiously according t
 7950.370 Supplier#000008101 GERMANY
 33094 Manufacturer#5 kkYvL6luvojJgTNG IKKaXQDYgx8lLohj
 17-627-663-8014 quickly regular requests are furiously. pending
 deposits wake
 7937.930 Supplier#000009012 ROMANIA
 83995 Manufacturer#2 iUiTziH,Ek3i4lwSgunXMgrcTzwdb
 29-250-925-9690 blithely bold ideas haggle quickly final, regular
 request
 7914.450 Supplier#000001013 RUSSIA
 125988 Manufacturer#2 riRcntps4KEDTYScjpMIWeYf6mNnR
 32-194-698-3365 final, ironic theodolites alongside of the ironic
 7912.910 Supplier#000004211 GERMANY
 159180 Manufacturer#5
 2wQRVovHrm3,v03IKzfTd,1PYsFXQFFOG 17-266-947-7315
 final requests integrate slyly above the silent, even
 7912.910 Supplier#000004211 GERMANY
 184210 Manufacturer#4
 2wQRVovHrm3,v03IKzfTd,1PYsFXQFFOG 17-266-947-7315
 final requests integrate slyly above the silent, even
 7894.560 Supplier#000007981 GERMANY
 85472 Manufacturer#4 NSJ96vMROAbeXP
 17-963-404-3760 regular, even theodolites integrate carefully. bold,
 special theodolites are slyly fluffy iron
 7887.080 Supplier#000009792 GERMANY
 164759 Manufacturer#3 Y28ITVeYriT3kIGdV2K8fSZ
 V2UqT5H1Otz 17-988-938-4296 pending, ironic packages sleep
 among the carefully ironic accounts. quickly final accounts
 7871.500 Supplier#000007206 RUSSIA
 104695 Manufacturer#1 3w fNCnrVmvJJE95sgWZzvW
 32-432-452-7731 furiously dogged pinto beans cajole. bold, express
 notornis until the slyly pending
 7852.450 Supplier#000005864 RUSSIA
 8363 Manufacturer#4 WCNfBPZeSxh3h,c 32-
 454-883-3821 blithely regular deposits
 7850.660 Supplier#000001518 UNITED KINGDOM
 86501 Manufacturer#1 ONda3YJIHKJOC 33-

730-383-3892 furiously final accounts wake carefully idle requests.
 even dolphins wake acc
 7843.520 Supplier#000006683 FRANCE
 11680 Manufacturer#4 Z20JGkiv01Y00oCFwUGfviIbhzCyd
 16-464-517-8943 carefully bold accounts doub

Number of rows retrieved is: 100

Query 3

-- Query 03 - Var_0 Rev_01 - Shipping Priority Query

Tag: Q3 Stream: -1 Sequence number: 11

```
select
  l_orderkey,
  sum(l_extendedprice * (1 - l_discount)) as revenue,
  o_orderdate,
  o_shippriority
from
  tpcd.customer,
  tpcd.orders,
  tpcd.lineitem
where
  c_mktsegment = 'BUILDING'
  and c_custkey = o_custkey
  and l_orderkey = o_orderkey
  and o_orderdate < date ('1995-03-15')
  and l_shipdate > date ('1995-03-15')
group by
  l_orderkey,
  o_orderdate,
  o_shippriority
order by
  revenue desc,
  o_orderdate
fetch first 10 rows only
```

L_ORDERKEY	REVENUE	O_ORDERDATE	O_SHIPPRIORITY
2456423	406181.011	1995-03-05	0
3459808	405838.699	1995-03-04	0
492164	390324.061	1995-02-19	0
1188320	384537.936	1995-03-09	0
2435712	378673.056	1995-02-26	0
4878020	378376.795	1995-03-12	0
5521732	375153.922	1995-03-13	0
2628192	373133.309	1995-02-22	0
993600	371407.459	1995-03-05	0
2300070	367371.145	1995-03-13	0

Number of rows retrieved is: 10

Query 4

-- Query 04 - Var_0 Rev_01 - Order Priority Checking Query

Tag: Q4 Stream: -1 Sequence number: 14

```
select
  o_orderpriority,
  count(*) as order_count
from
  tpcd.orders
where
  o_orderdate >= date ('1993-07-01')
  and o_orderdate < date ('1993-07-01') + 3 month
  and exists (
  select
  *
  from
```

```

tpcd.lineitem
where
l_orderkey = o_orderkey
and l_commitdate < l_receiptdate
)
group by
o_orderpriority
order by
o_orderpriority

```

O_ORDERPRIORITY ORDER_COUNT

```

-----
1-URGENT          10594
2-HIGH            10476
3-MEDIUM         10410
4-NOT SPECIFIED  10556
5-LOW            10487

```

Number of rows retrieved is: 5

Query 5

-- Query 05 - Var_0 Rev_02 Local Supplier Volume Query

Tag: Q5 Stream: -1 Sequence number: 20

```

select
n_name,
sum(l_extendedprice * (1 - l_discount)) as revenue
from
tpcd.customer,
tpcd.orders,
tpcd.lineitem,
tpcd.supplier,
tpcd.nation,
tpcd.region
where
c_custkey = o_custkey
and o_orderkey = l_orderkey
and l_suppkey = s_suppkey
and c_nationkey = s_nationkey
and s_nationkey = n_nationkey
and n_regionkey = r_regionkey
and r_name = 'ASIA'
and o_orderdate >= date ('1994-01-01')
and o_orderdate < date ('1994-01-01') + 1 year
group by
n_name
order by
revenue desc

```

```

N_NAME          REVENUE
-----
INDONESIA        55502041.170
VIETNAM         55295086.997
CHINA           53724494.257
INDIA           52035512.000
JAPAN           45410175.695

```

Number of rows retrieved is: 5

Query 6

-- Query 06 - Var_0 Rev_01 - Forecasting Revenue Change Query

Tag: Q6 Stream: -1 Sequence number: 5

```

select
sum(l_extendedprice * l_discount) as revenue
from
tpcd.lineitem

```

```

where
l_shipdate >= date ('1994-01-01')
and l_shipdate < date ('1994-01-01') + 1 year
and l_discount between .06 - 0.01 and .06 + 0.01
and l_quantity < 24

```

REVENUE

123141078.228

Number of rows retrieved is: 1

Query 7

-- Query 07 - Var_0 Rev_01 - Volume Shipping Query

Tag: Q7 Stream: -1 Sequence number: 21

```

select
supp_nation,
cust_nation,
l_year,
sum(volume) as revenue
from
(
select
n1.n_name as supp_nation,
n2.n_name as cust_nation,
year (l_shipdate) as l_year,
l_extendedprice * (1 - l_discount) as volume
from
tpcd.supplier,
tpcd.lineitem,
tpcd.orders,
tpcd.customer,
tpcd.nation n1,
tpcd.nation n2
where
s_suppkey = l_suppkey
and o_orderkey = l_orderkey
and c_custkey = o_custkey
and s_nationkey = n1.n_nationkey
and c_nationkey = n2.n_nationkey
and (
(n1.n_name = 'FRANCE' and n2.n_name = 'GERMANY')
or (n1.n_name = 'GERMANY' and n2.n_name = 'FRANCE')
)
and l_shipdate between date ('1995-01-01') and date ('1996-12-31')
) as shipping
group by
supp_nation,
cust_nation,
l_year
order by
supp_nation,
cust_nation,
l_year

```

```

SUPP_NATION      CUST_NATION      L_YEAR
REVENUE
-----

```

```

FRANCE          GERMANY          1995
54639732.734
FRANCE          GERMANY          1996
54633083.308
GERMANY         FRANCE           1995
52531746.670
GERMANY         FRANCE           1996
52520549.022

```

Number of rows retrieved is: 4

Query 8

-- Query 08 - Var_0 Rev_01 - National Market Share Query

Tag: Q8 Stream: -1 Sequence number: 8

```

select
o_year,
sum(case
when nation = 'BRAZIL' then volume
else 0
end) / sum(volume) as mkt_share
from
(
select
year(o_orderdate) as o_year,
l_extendedprice * (1 - l_discount) as volume,
n2.n_name as nation
from
tpcd.part,
tpcd.supplier,
tpcd.lineitem,
tpcd.orders,
tpcd.customer,
tpcd.nation n1,
tpcd.nation n2,
tpcd.region
where
p_partkey = l_partkey
and s_suppkey = l_suppkey
and l_orderkey = o_orderkey
and o_custkey = c_custkey
and c_nationkey = n1.n_nationkey
and n1.n_regionkey = r_regionkey
and r_name = 'AMERICA'
and s_nationkey = n2.n_nationkey
and o_orderdate between date('1995-01-01') and date ('1996-12-31')
and p_type = 'ECONOMY ANODIZED STEEL'
) as all_nations
group by
o_year
order by
o_year

```

O_YEAR	MKT_SHARE
1995	0.034
1996	0.041

Number of rows retrieved is: 2

Query 9

-- Query 09 - Var_0 Rev_01 - Product Type Profit Measure Query

Tag: Q9 Stream: -1 Sequence number: 3

```

select
nation,
o_year,
sum(amount) as sum_profit
from
(
select
n_name as nation,
year(o_orderdate) as o_year,
l_extendedprice * (1 - l_discount) - ps_supplycost * l_quantity as
amount
from

```

```

tpcd.part,
tpcd.supplier,
tpcd.lineitem,
tpcd.partsupp,
tpcd.orders,
tpcd.nation
where
s_suppkey = l_suppkey
and ps_suppkey = l_suppkey
and ps_partkey = l_partkey
and p_partkey = l_partkey
and o_orderkey = l_orderkey
and s_nationkey = n_nationkey
and p_name like '%green%'
) as profit
group by
nation,
o_year
order by
nation,
o_year desc

```

NATION	O_YEAR	SUM_PROFIT
ALGERIA	1998	31342867.235
ALGERIA	1997	57138193.023
ALGERIA	1996	56140140.133
ALGERIA	1995	53051469.653
ALGERIA	1994	53867582.129
ALGERIA	1993	54942718.132
ALGERIA	1992	54628034.713
ARGENTINA	1998	30211185.708
ARGENTINA	1997	50805741.752
ARGENTINA	1996	51923746.575
ARGENTINA	1995	49298625.767
ARGENTINA	1994	50835610.109
ARGENTINA	1993	51646079.178
ARGENTINA	1992	50410314.995
BRAZIL	1998	27217924.383
BRAZIL	1997	48378669.199
BRAZIL	1996	50482870.357
BRAZIL	1995	47623383.635
BRAZIL	1994	47840165.726
BRAZIL	1993	49054694.035
BRAZIL	1992	48667639.084
CANADA	1998	30379833.769
CANADA	1997	50465052.311
CANADA	1996	52560501.390
CANADA	1995	52375332.809
CANADA	1994	52600364.659
CANADA	1993	52644504.073
CANADA	1992	53932871.697
CHINA	1998	31075466.165
CHINA	1997	50551874.450
CHINA	1996	51039293.875
CHINA	1995	49287534.617
CHINA	1994	50851090.067
CHINA	1993	54229629.833
CHINA	1992	52400529.372
EGYPT	1998	29054433.386
EGYPT	1997	50627611.452
EGYPT	1996	49542212.845
EGYPT	1995	48311550.321
EGYPT	1994	49790644.736
EGYPT	1993	48904292.969
EGYPT	1992	49434932.619
ETHIOPIA	1998	28040717.267
ETHIOPIA	1997	47455009.866
ETHIOPIA	1996	46491097.573
ETHIOPIA	1995	46804449.301

ETHIOPIA	1994	48516143.917
ETHIOPIA	1993	46551891.563
ETHIOPIA	1992	44934648.643
FRANCE	1998	32226407.839
FRANCE	1997	47121485.860
FRANCE	1996	47263135.496
FRANCE	1995	47275997.571
FRANCE	1994	47067209.332
FRANCE	1993	51163370.106
FRANCE	1992	47846235.331
GERMANY	1998	28624942.660
GERMANY	1997	49309074.877
GERMANY	1996	49918683.168
GERMANY	1995	52650718.724
GERMANY	1994	50346900.423
GERMANY	1993	50991895.806
GERMANY	1992	48274126.099
INDIA	1998	29943144.354
INDIA	1997	50665453.231
INDIA	1996	50283092.291
INDIA	1995	50006774.645
INDIA	1994	48995190.756
INDIA	1993	50286902.852
INDIA	1992	50850329.402
INDONESIA	1998	27672339.997
INDONESIA	1997	50512145.726
INDONESIA	1996	51653060.117
INDONESIA	1995	51508779.594
INDONESIA	1994	52817950.322
INDONESIA	1993	47959994.955
INDONESIA	1992	51776605.032

[some lines deleted]

UNITED KINGDOM	1998	28494874.004
UNITED KINGDOM	1997	49381810.899
UNITED KINGDOM	1996	51386853.960
UNITED KINGDOM	1995	51509586.788
UNITED KINGDOM	1994	48086499.711
UNITED KINGDOM	1993	49166827.224
UNITED KINGDOM	1992	49349122.083
UNITED STATES	1998	25126238.946
UNITED STATES	1997	50077306.419
UNITED STATES	1996	48048649.470
UNITED STATES	1995	48809032.423
UNITED STATES	1994	49296747.183
UNITED STATES	1993	48029946.801
UNITED STATES	1992	48671944.498
VIETNAM	1998	30442736.059
VIETNAM	1997	50309179.794
VIETNAM	1996	50488161.410
VIETNAM	1995	49658284.612
VIETNAM	1994	50596057.261
VIETNAM	1993	50953919.152
VIETNAM	1992	49613838.315

Number of rows retrieved is: 175

Query 10

-- Query 10 - Var_0 Rev_01 - Returned Item Reporting Query

Tag: Q10 Stream: -1 Sequence number: 18

```
select
c_custkey,
c_name,
sum(l_extendedprice * (1 - l_discount)) as revenue,
c_acctbal,
n_name,
c_address,
```

```
c_phone,
c_comment
from
tpcd.customer,
tpcd.orders,
tpcd.lineitem,
tpcd.nation
where
c_custkey = o_custkey
and l_orderkey = o_orderkey
and o_orderdate >= date ('1993-10-01')
and o_orderdate < date ('1993-10-01') + 3 month
and l_returnflag = 'R'
and c_nationkey = n_nationkey
group by
c_custkey,
c_name,
c_acctbal,
c_phone,
n_name,
c_address,
c_comment
order by
revenue desc
fetch first 20 rows only
```

C_CUSTKEY	C_NAME	REVENUE
C_ACCTBAL	N_NAME	C_ADDRESS
C_PHONE	C_COMMENT	

```
-----
-----
-----
-----
57040 Customer#000057040 734235.246
632.870 JAPAN Eioryzjf4pp 22-895-
641-3466 requests sleep blithely about the furiously i
143347 Customer#000143347 721002.695
2557.470 EGYPT 1aReFYv,Kw4 14-
742-935-3718 fluffily bold excuses haggle finally after the u
60838 Customer#000060838 679127.308
2454.770 BRAZIL 64EaJ5vMAHWJIBOXJklpNc2RJiWE
12-913-494-9813 furiously even pinto beans integrate under the
ruthless foxes; ironic, even dolphins across the slyl
101998 Customer#000101998 637029.567
3790.890 UNITED KINGDOM 01c9CilNnfrOQYmZj
33-593-865-6378 accounts doze blithely! enticing, final deposits sleep
blihtely special accounts. slyly express accounts pla
125341 Customer#000125341 633508.086
4983.510 GERMANY S29ODD6bceU8QSuuEJznkNaK
17-582-695-5962 quickly express requests wake quickly blithely
25501 Customer#000025501 620269.785
7725.040 ETHIOPIA
W556MxuoiaYCCZamJI,Rn0B4ACUGdkQ8DZ 15-874-808-6793
quickly special requests sleep evenly among the special deposits.
special deposi
115831 Customer#000115831 596423.867
5098.100 FRANCE rFeBbEEYk dl
ne7zV5fDrmiq1oK09wV7pxqCgIc 16-715-386-3788 carefully bold
excuses sleep alongside of the thinly idle
84223 Customer#000084223 594998.024
528.650 UNITED KINGDOM nAVZCs6BaWap rM27N
2qBnzc5WBauxbA 33-442-824-8191 pending, final ideas haggle
final requests. unusual, regular asymptotes affix according to the even
foxes.
54289 Customer#000054289 585603.392
5583.020 IRAN vXCxoCsU0Bad5JQI ,oobkZ
20-834-292-4707 express requests sublata blithely regular requests.
regular, even ideas solve.
39922 Customer#000039922 584878.113
7321.110 GERMANY
```

Zgy4s50I2GKN4pLDPBU8m342glw6R 17-147-757-8036 even
 pinto beans haggie. slyly bold accounts inte
 6226 Customer#000006226 576783.761
 2230.090 UNITED KINGDOM
 8gPu8,NPGkfyQQ0hclYUGPIBWc,ybP5g, 33-657-701-3391
 quickly final requests against the regular instructions wake blithely final
 instructions. pa
 922 Customer#000000922 576767.533
 3869.250 GERMANY
 Az9RFaut7NkPnc5zSD2PwHgVvr4jRzq 17-945-916-9648
 boldly final requests cajole blith
 147946 Customer#000147946 576455.132
 2030.130 ALGERIA iANyZHjqhyy7Ajah0pTrYyhJ
 10-886-956-3143 furiously even accounts are blithely above the
 furiousl
 115640 Customer#000115640 569341.193
 6436.100 ARGENTINA Vtgfia9ql 7EpHgecU1X
 11-411-543-4901 final instructions are slyly according to the
 73606 Customer#000073606 568656.858
 1785.670 JAPAN xuR0Tro5yChDfOCrjkd2ol
 22-437-653-6966 furiously bold orbits about the furiously busy
 requests wake across the furiously quiet theodolites. d
 110246 Customer#000110246 566842.982
 7763.350 VIETNAM 7KzflgX MDOq7sOkI
 31-943-426-9837 dolphins sleep blithely among the slyly final
 142549 Customer#000142549 563537.237
 5085.990 INDONESIA
 ChqEoK43OysjdHbtKCp6dKqjNyyvi9 19-955-562-2398 regular,
 unusual dependencies boost slyly; ironic attainments nag fluffily into
 the unusual packages?
 146149 Customer#000146149 557254.986
 1791.550 ROMANIA s87fvzFQpU 29-
 744-164-6487 silent, unusual requests detect quickly slyly regul
 52528 Customer#000052528 556397.351
 551.790 ARGENTINA NFztyTOR10UOJ
 11-208-192-3205 unusual requests detect. slyly dogged theodolites
 use slyly. deposit
 23431 Customer#000023431 554269.536
 3381.860 ROMANIA HgiV0phqhala9aydNollb
 29-915-458-2654 instructions nag quickly. furiously bold accounts
 cajol

Number of rows retrieved is: 20

Query 11

-- Query 11 - Var_0 Rev_01 - Important Stock Identification Query

Tag: Q11 Stream: -1 Sequence number: 15

```

select
ps_partkey,
sum(ps_supplycost * ps_availqty) as value
from
tpcd.partsupp,
tpcd.supplier,
tpcd.nation
where
ps_suppkey = s_suppkey
and s_nationkey = n_nationkey
and n_name = 'GERMANY'
group by
ps_partkey having
sum(ps_supplycost * ps_availqty) > (
select
sum(ps_supplycost * ps_availqty) * 0.0001000000
from
tpcd.partsupp,
tpcd.supplier,
tpcd.nation

```

```

where
ps_suppkey = s_suppkey
and s_nationkey = n_nationkey
and n_name = 'GERMANY'
)
order by
value desc

```

PS_PARTKEY	VALUE
129760	17538456.860
166726	16503353.920
191287	16474801.970
161758	16101755.540
34452	15983844.720
139035	15907078.340
9403	15451755.620
154358	15212937.880
38823	15064802.860
85606	15053957.150
33354	14408297.400
154747	14407580.680
82865	14235489.780
76094	14094247.040
222	13937777.740
121271	13908336.000
55221	13716120.470
22819	13666434.280
76281	13646853.680
85298	13581154.930
85158	13554904.000
139684	13535538.720
31034	13498025.250
87305	13482847.040
10181	13445148.750
62323	13411824.300
26489	13377256.380
96493	13339057.830
56548	13329014.970
55576	13306843.350
159751	13306614.480
92406	13287414.500
182636	13223726.740
199969	13135288.210
62865	13001926.940
7284	12945298.190
197867	12944510.520
11562	12931575.510
75165	12916918.120
97175	12911283.500
140840	12896562.230
65241	12890600.460
166120	12876927.220
9035	12863828.700
144616	12853549.300
176723	12832309.740
170884	12792136.580
29790	12723300.330
95213	12555483.730
183873	12550533.050
171235	12476538.300
21533	12437821.320
17290	12432159.500
156397	12260623.500
122611	12222812.980
139155	12220319.250
146316	12215800.610
171381	12199734.520
198633	12078226.950
167417	12046637.620

59512	12043468.760
31688	12034893.640
159586	12001505.840
8993	11963814.300
120302	11857707.550
43536	11779340.520
9552	11776909.160
86223	11772205.080
53776	11758669.650
131285	11616953.740
91628	11611114.830
169644	11567959.720
182299	11567462.050
33107	11453818.760
104184	11436657.440
67027	11419127.140
176869	11371451.710
30885	11369674.790
54420	11345076.880
72240	11313951.050
178708	11294635.170
81298	11273686.130
158324	11243442.720
117095	11242535.240
176793	11237733.380
86091	11177793.790
116033	11145434.360
129058	11119112.200
193714	11104706.390
117195	11077217.960
49851	11043701.780
19791	11030662.620
75800	11012401.620
161562	10996371.690
10119	10980015.750
39185	10970042.560
47223	10950022.130
175594	10942923.050
111295	10893675.610
155446	10852764.570
156391	10839810.380
40884	10837234.190
141288	10837130.210
152388	10830977.820
33449	10830858.720
149035	10826130.020
162620	10814275.680
118324	10791788.100
38932	10777541.750

[rows deleted]

139680	7939242.360
31134	7938318.300
45636	7937240.850
56694	7936015.950
8114	7933921.880
71518	7932261.690
72922	7930400.640
146699	7929167.400
92387	7928972.670
186289	7928786.190
95952	7927972.780
196514	7927180.700
4403	7925729.040
2267	7925649.370
45924	7925047.680
11493	7916722.230
104478	7916253.600
166794	7913842.000
161995	7910874.270

23538	7909752.060
41093	7909579.920
112073	7908617.570
92814	7908262.500
88919	7907992.500
79753	7907933.880
108765	7905338.980
146530	7905336.600
71475	7903367.580
36289	7901946.500
61739	7900794.000
52338	7898638.080
194299	7898421.240
105235	7897829.940
77207	7897752.720
96712	7897575.270
10157	7897046.250
171154	7896814.500
79373	7896186.000
113808	7893353.880
27901	7892952.000
128820	7892882.720
25891	7890511.200
122819	7888881.020
154731	7888301.330
101674	7879324.600
51968	7879102.210
72073	7877736.110
5182	7874521.730

Number of rows retrieved is: 1048

Query 12

-- Query 12 - Var_0 Rev_02 - Shipping Modes and Order Priority Query

Tag: Q12 Stream: -1 Sequence number: 22

```

select
  l_shipmode,
  sum(case
    when o_orderpriority = '1-URGENT'
    or o_orderpriority = '2-HIGH'
  then 1
  else 0
  end) as high_line_count,
  sum(case
    when o_orderpriority <> '1-URGENT'
    and o_orderpriority <> '2-HIGH'
  then 1
  else 0
  end) as low_line_count
from
  tpcd.orders,
  tpcd.lineitem
where
  o_orderkey = l_orderkey
  and l_shipmode in ('MAIL', 'SHIP')
  and l_commitdate < l_receiptdate
  and l_shipdate < l_commitdate
  and l_receiptdate >= date ('1994-01-01')
  and l_receiptdate < date ('1994-01-01') + 1 year
group by
  l_shipmode
order by
  l_shipmode

```

L_SHIPMODE	HIGH_LINE_COUNT	LOW_LINE_COUNT
------------	-----------------	----------------

MAIL	6202	9324
------	------	------

SHIP 6200 9262

Number of rows retrieved is: 2

Query 13

-- Query 13 - Var_0 Rev_01 - Customer Distribution Query

Tag: Q13 Stream: -1 Sequence number: 10

```

select
c_count,
count(*) as custdist
from
(
select
c_custkey,
count(o_orderkey)
from
tpcd.customer left outer join tpcd.orders on
c_custkey = o_custkey
and o_comment not like '%special%requests%'
group by
c_custkey
) as c_orders (c_custkey, c_count)
group by
c_count
order by
custdist desc,
c_count desc

```

C_COUNT	CUSTDIST
0	50004
9	6641
10	6566
11	6058
8	5949
12	5553
13	4989
19	4748
7	4707
18	4625
15	4552
17	4530
14	4484
20	4461
16	4323
21	4217
22	3730
6	3334
23	3129
24	2622
25	2079
5	1972
26	1593
27	1185
4	1033
28	869
29	559
3	398
30	373
31	235
2	144
32	128
33	71
34	48
35	33
1	23
36	17

37	7
40	4
38	4
39	2
41	1

Number of rows retrieved is: 42

Query 14

-- Query 14 - Var_0 Rev_01 - Promotion Effect Query

Tag: Q14 Stream: -1 Sequence number: 1

```

select
100.00 * sum(case
when p_type like 'PROMO%'
then l_extendedprice * (1 - l_discount)
else 0
end) / sum(l_extendedprice * (1 - l_discount)) as promo_revenue
from
tpcd.lineitem,
tpcd.part
where
l_partkey = p_partkey
and l_shipdate >= date ('1995-09-01')
and l_shipdate < date ('1995-09-01') + 1 month

```

PROMO_REVENUE

16.381

Number of rows retrieved is: 1

Query 15

-- Query 15 - Var_a Rev_01 - Top Supplier Query

Tag: Q15a Stream: -1 Sequence number: 16

```

with revenue (supplier_no, total_revenue) as (
select
l_suppkey,
sum(l_extendedprice * (1-l_discount))
from
tpcd.lineitem
where
l_shipdate >= date ('1996-01-01')
and l_shipdate < date ('1996-01-01') + 3 month
group by
l_suppkey
)
select
s_suppkey,
s_name,
s_address,
s_phone,
total_revenue
from
tpcd.supplier,
revenue
where
s_suppkey = supplier_no
and total_revenue = (
select
max(total_revenue)
from
revenue
)
order by
s_suppkey

```

S_SUPPKEY	S_NAME	S_ADDRESS
S_PHONE	TOTAL_REVENUE	
8449	Supplier#000008449	Wp34zim9qYFbVctdW
20-469-856-8873	1772627.209	

Number of rows retrieved is: 1

Query 16

-- Query 16 - Var_0 Rev_01 - Parts/Supplier Relationship Query

Tag: Q16 Stream: -1 Sequence number: 13

```

select
p_brand,
p_type,
p_size,
count(distinct ps_suppkey) as supplier_cnt
from
tpcd.partsupp,
tpcd.part
where
p_partkey = ps_partkey
and p_brand <> 'Brand#45'
and p_type not like 'MEDIUM POLISHED%'
and p_size in (49, 14, 23, 45, 19, 3, 36, 9)
and ps_suppkey not in (
select
s_suppkey
from
tpcd.supplier
where
s_comment like '%Customer%Complaints%'
)
group by
p_brand,
p_type,
p_size
order by
supplier_cnt desc,
p_brand,
p_type,
p_size

```

P_BRAND	P_TYPE	P_SIZE	SUPPLIER_CNT
Brand#41	MEDIUM BRUSHED TIN	3	28
Brand#54	STANDARD BRUSHED COPPER	14	27
Brand#11	STANDARD BRUSHED TIN	23	24
Brand#11	STANDARD BURNISHED BRASS	36	24
Brand#15	MEDIUM ANODIZED NICKEL	3	24
Brand#15	SMALL ANODIZED BRASS	45	24
Brand#15	SMALL BURNISHED NICKEL	19	24
Brand#21	MEDIUM ANODIZED COPPER	3	24
Brand#22	SMALL BRUSHED NICKEL	3	24
Brand#22	SMALL BURNISHED BRASS	19	24
Brand#25	MEDIUM BURNISHED COPPER	36	24
Brand#31	PROMO POLISHED COPPER	36	24
Brand#33	LARGE POLISHED TIN	23	24
Brand#33	PROMO POLISHED STEEL	14	24
Brand#35	PROMO BRUSHED NICKEL	14	24
Brand#41	ECONOMY BRUSHED STEEL	9	24
Brand#41	ECONOMY POLISHED TIN	19	24
Brand#41	LARGE PLATED COPPER	36	24
Brand#42	ECONOMY PLATED BRASS	3	24
Brand#42	STANDARD POLISHED TIN	49	24
Brand#43	PROMO BRUSHED TIN	3	24

Brand#43	SMALL ANODIZED COPPER	36	24
Brand#44	STANDARD POLISHED NICKEL	3	24
Brand#52	ECONOMY PLATED TIN	14	24
Brand#52	STANDARD BURNISHED NICKEL	3	24
Brand#53	MEDIUM ANODIZED STEEL	14	24
Brand#14	PROMO ANODIZED NICKEL	45	23
Brand#32	ECONOMY PLATED BRASS	9	23
Brand#52	SMALL ANODIZED COPPER	3	23
Brand#11	ECONOMY BRUSHED COPPER	45	20
Brand#11	ECONOMY PLATED BRASS	23	20
Brand#11	LARGE BRUSHED COPPER	49	20
Brand#11	LARGE POLISHED COPPER	49	20
Brand#12	STANDARD ANODIZED TIN	49	20
Brand#12	STANDARD PLATED BRASS	19	20
Brand#13	ECONOMY BRUSHED BRASS	9	20
Brand#13	ECONOMY BURNISHED STEEL	14	20
Brand#13	LARGE BURNISHED NICKEL	19	20
Brand#13	MEDIUM BURNISHED COPPER	36	20
Brand#13	SMALL BRUSHED TIN	45	20
Brand#13	STANDARD ANODIZED COPPER	3	20
Brand#13	STANDARD PLATED NICKEL	23	20
Brand#14	ECONOMY ANODIZED COPPER	14	20
Brand#14	ECONOMY PLATED TIN	36	20
Brand#14	ECONOMY POLISHED NICKEL	3	20
Brand#14	MEDIUM ANODIZED NICKEL	3	20
Brand#14	SMALL POLISHED TIN	14	20
Brand#15	MEDIUM ANODIZED COPPER	9	20
Brand#15	MEDIUM PLATED TIN	23	20
Brand#15	PROMO PLATED BRASS	14	20
Brand#15	SMALL ANODIZED COPPER	45	20
Brand#15	SMALL PLATED COPPER	49	20
Brand#15	STANDARD PLATED TIN	3	20
Brand#21	LARGE ANODIZED COPPER	36	20
Brand#21	LARGE BRUSHED TIN	3	20
Brand#21	MEDIUM ANODIZED COPPER	14	20
Brand#21	PROMO BRUSHED TIN	36	20
Brand#21	PROMO POLISHED NICKEL	45	20
Brand#21	SMALL ANODIZED COPPER	9	20
Brand#21	SMALL POLISHED NICKEL	23	20
Brand#22	LARGE ANODIZED COPPER	36	20
Brand#22	LARGE BRUSHED COPPER	49	20
Brand#22	PROMO ANODIZED TIN	49	20
Brand#22	PROMO POLISHED BRASS	45	20
Brand#22	SMALL BURNISHED STEEL	45	20
Brand#23	MEDIUM ANODIZED STEEL	45	20
Brand#23	PROMO POLISHED STEEL	23	20
Brand#23	STANDARD BRUSHED TIN	14	20
Brand#23	STANDARD PLATED NICKEL	36	20
Brand#24	PROMO PLATED COPPER	49	20
Brand#24	PROMO PLATED STEEL	49	20
Brand#24	PROMO POLISHED STEEL	9	20
Brand#24	STANDARD BRUSHED TIN	36	20
Brand#25	LARGE ANODIZED BRASS	3	20
Brand#25	PROMO BURNISHED TIN	3	20
Brand#31	ECONOMY POLISHED NICKEL	3	20
Brand#31	MEDIUM PLATED TIN	45	20
Brand#31	SMALL ANODIZED STEEL	14	20
Brand#32	ECONOMY ANODIZED COPPER	36	20
Brand#32	ECONOMY BRUSHED NICKEL	49	20
Brand#32	LARGE ANODIZED TIN	19	20
Brand#32	MEDIUM BURNISHED COPPER	19	20
Brand#32	SMALL ANODIZED STEEL	45	20
Brand#33	ECONOMY POLISHED COPPER	19	20
Brand#33	PROMO PLATED NICKEL	14	20
Brand#33	SMALL POLISHED TIN	9	20
Brand#33	STANDARD ANODIZED BRASS	49	20
Brand#33	STANDARD BURNISHED BRASS	45	20
Brand#34	ECONOMY BRUSHED NICKEL	49	20
Brand#34	LARGE BRUSHED BRASS	19	20
Brand#34	SMALL BRUSHED TIN	3	20

Brand#34	STANDARD PLATED COPPER	9	20
Brand#35	LARGE ANODIZED NICKEL	3	20
Brand#35	MEDIUM ANODIZED BRASS	45	20
Brand#35	MEDIUM ANODIZED STEEL	23	20
Brand#35	PROMO ANODIZED COPPER	49	20
Brand#35	SMALL POLISHED COPPER	14	20
Brand#41	LARGE ANODIZED STEEL	3	20
Brand#41	LARGE BRUSHED NICKEL	23	20
Brand#41	LARGE BURNISHED COPPER	3	20
Brand#41	MEDIUM PLATED STEEL	19	20
Brand#41	SMALL BURNISHED COPPER	23	20
Brand#42	MEDIUM BURNISHED BRASS	14	20
Brand#42	SMALL BURNISHED COPPER	3	20
Brand#43	ECONOMY POLISHED COPPER	9	20
Brand#43	SMALL PLATED STEEL	3	20
Brand#43	STANDARD BURNISHED TIN	23	20
Brand#44	LARGE ANODIZED STEEL	23	20

[rows deleted]

Brand#55	STANDARD BURNISHED TIN	36	4
Brand#55	STANDARD BURNISHED TIN	49	4
Brand#55	STANDARD PLATED BRASS	9	4
Brand#55	STANDARD PLATED BRASS	45	4
Brand#55	STANDARD PLATED BRASS	49	4
Brand#55	STANDARD PLATED COPPER	9	4
Brand#55	STANDARD PLATED COPPER	45	4
Brand#55	STANDARD PLATED NICKEL	3	4
Brand#55	STANDARD PLATED NICKEL	19	4
Brand#55	STANDARD PLATED NICKEL	45	4
Brand#55	STANDARD PLATED STEEL	14	4
Brand#55	STANDARD PLATED STEEL	23	4
Brand#55	STANDARD PLATED STEEL	49	4
Brand#55	STANDARD PLATED TIN	9	4
Brand#55	STANDARD PLATED TIN	14	4
Brand#55	STANDARD PLATED TIN	36	4
Brand#55	STANDARD POLISHED BRASS	3	4
Brand#55	STANDARD POLISHED BRASS	9	4
Brand#55	STANDARD POLISHED BRASS	23	4
Brand#55	STANDARD POLISHED COPPER	3	4
Brand#55	STANDARD POLISHED COPPER	23	4
Brand#55	STANDARD POLISHED COPPER	45	4
Brand#55	STANDARD POLISHED NICKEL	3	4
Brand#55	STANDARD POLISHED NICKEL	23	4
Brand#55	STANDARD POLISHED NICKEL	36	4
Brand#55	STANDARD POLISHED NICKEL	45	4
Brand#55	STANDARD POLISHED NICKEL	49	4
Brand#55	STANDARD POLISHED STEEL	14	4
Brand#55	STANDARD POLISHED STEEL	23	4
Brand#55	STANDARD POLISHED TIN	9	4
Brand#55	STANDARD POLISHED TIN	19	4
Brand#55	STANDARD POLISHED TIN	36	4
Brand#11	SMALL BRUSHED TIN	19	3
Brand#15	LARGE PLATED NICKEL	45	3
Brand#15	LARGE POLISHED NICKEL	9	3
Brand#21	PROMO BURNISHED STEEL	45	3
Brand#22	STANDARD PLATED STEEL	23	3
Brand#25	LARGE PLATED STEEL	19	3
Brand#32	STANDARD ANODIZED COPPER	23	3
Brand#33	SMALL ANODIZED BRASS	9	3
Brand#35	MEDIUM ANODIZED TIN	19	3
Brand#51	SMALL PLATED BRASS	23	3
Brand#52	MEDIUM BRUSHED BRASS	45	3
Brand#53	MEDIUM BRUSHED TIN	45	3
Brand#54	ECONOMY POLISHED BRASS	9	3
Brand#55	PROMO PLATED BRASS	19	3
Brand#55	STANDARD PLATED TIN	49	3

Number of rows retrieved is: 18314

Query 17

-- Query 17 - Var_0 Rev_01 - Small-Quantity-Order Revenue Query

Tag: Q17 Stream: -1 Sequence number: 6

```
select
sum(l_extendedprice) / 7.0 as avg_yearly
from
tpcd.lineitem,
tpcd.part
where
p_partkey = l_partkey
and p_brand = 'Brand#23'
and p_container = 'MED BOX'
and l_quantity < (
select
0.2 * avg(l_quantity)
from
tpcd.lineitem
where
l_partkey = p_partkey
)
```

AVG_YEARLY

348406.054

Number of rows retrieved is: 1

Query 18

-- Query 18 - Var_0 Rev_01 - Large Volume Customer Query

Tag: Q18 Stream: -1 Sequence number: 7

```
select
c_name,
c_custkey,
o_orderkey,
o_orderdate,
o_totalprice,
sum(l_quantity)
from
tpcd.customer,
tpcd.orders,
tpcd.lineitem
where
o_orderkey in (
select
l_orderkey
from
tpcd.lineitem
group by
l_orderkey having
sum(l_quantity) > 300
)
and c_custkey = o_custkey
and o_orderkey = l_orderkey
group by
c_name,
c_custkey,
o_orderkey,
o_orderdate,
o_totalprice
order by
o_totalprice desc,
o_orderdate
fetch first 100 rows only
```

C_NAME	C_CUSTKEY	O_ORDERKEY	O_ORDERDATE	O_TOTALPRICE	O_ORDERKEY
Customer#000128120	128120	4722021	1994-04-07		
544089.090	323.000				
Customer#000144617	144617	3043270	1997-02-12		
530604.440	317.000				
Customer#000013940	13940	2232932	1997-04-13		
522720.610	304.000				
Customer#000066790	66790	2199712	1996-09-30		
515531.820	327.000				
Customer#000046435	46435	4745607	1997-07-03		
508047.990	309.000				
Customer#000015272	15272	3883783	1993-07-28		
500241.330	302.000				
Customer#000146608	146608	3342468	1994-06-12		
499794.580	303.000				
Customer#000096103	96103	5984582	1992-03-16		
494398.790	312.000				
Customer#000024341	24341	1474818	1992-11-15		
491348.260	302.000				
Customer#000137446	137446	5489475	1997-05-23		
487763.250	311.000				
Customer#000107590	107590	4267751	1994-11-04		
485141.380	301.000				
Customer#000050008	50008	2366755	1996-12-09		
483891.260	302.000				
Customer#000015619	15619	3767271	1996-08-07		
480083.960	318.000				
Customer#000077260	77260	1436544	1992-09-12		
479499.430	307.000				
Customer#000109379	109379	5746311	1996-10-10		
478064.110	302.000				
Customer#000054602	54602	5832321	1997-02-09		
471220.080	307.000				
Customer#000105995	105995	2096705	1994-07-03		
469692.580	307.000				
Customer#000148885	148885	2942469	1992-05-31		
469630.440	313.000				
Customer#000114586	114586	551136	1993-05-19		
469605.590	308.000				
Customer#000105260	105260	5296167	1996-09-06		
469360.570	303.000				
Customer#000147197	147197	1263015	1997-02-02		
467149.670	320.000				
Customer#000064483	64483	2745894	1996-07-04		
466991.350	304.000				
Customer#000136573	136573	2761378	1996-05-31		
461282.730	301.000				
Customer#000016384	16384	502886	1994-04-12		
458378.920	312.000				
Customer#000117919	117919	2869152	1996-06-20		
456815.920	317.000				
Customer#000012251	12251	735366	1993-11-24		
455107.260	309.000				
Customer#000120098	120098	1971680	1995-06-14		
453451.230	308.000				
Customer#000066098	66098	5007490	1992-08-07		
453436.160	304.000				
Customer#000117076	117076	4290656	1997-02-05		
449545.850	301.000				
Customer#000129379	129379	4720454	1997-06-07		
448665.790	303.000				
Customer#000126865	126865	4702759	1994-11-07		
447606.650	320.000				
Customer#000088876	88876	983201	1993-12-30		
446717.460	304.000				
Customer#000036619	36619	4806726	1995-01-17		
446704.090	328.000				

Customer#000141823	141823	2806245	1996-12-29		
446269.120	310.000				
Customer#000053029	53029	2662214	1993-08-13		
446144.490	302.000				
Customer#000018188	18188	3037414	1995-01-25		
443807.220	308.000				
Customer#000066533	66533	29158	1995-10-21		
443576.500	305.000				
Customer#000037729	37729	4134341	1995-06-29		
441082.970	309.000				
Customer#000003566	3566	2329187	1998-01-04		
439803.360	304.000				
Customer#000045538	45538	4527553	1994-05-22		
436275.310	305.000				
Customer#000081581	81581	4739650	1995-11-04		
435405.900	305.000				
Customer#000119989	119989	1544643	1997-09-20		
434568.250	320.000				
Customer#000003680	3680	3861123	1998-07-03		
433525.970	301.000				
Customer#000113131	113131	967334	1995-12-15		
432957.750	301.000				
Customer#000141098	141098	565574	1995-09-24		
430986.690	301.000				
Customer#000093392	93392	5200102	1997-01-22		
425487.510	304.000				
Customer#000015631	15631	1845057	1994-05-12		
419879.590	302.000				
Customer#000112987	112987	4439686	1996-09-17		
418161.490	305.000				
Customer#000012599	12599	4259524	1998-02-12		
415200.610	304.000				
Customer#000105410	105410	4478371	1996-03-05		
412754.510	302.000				
Customer#000149842	149842	5156581	1994-05-30		
411329.350	302.000				
Customer#000010129	10129	5849444	1994-03-21		
409129.850	309.000				
Customer#000069904	69904	1742403	1996-10-19		
408513.000	305.000				
Customer#000017746	17746	6882	1997-04-09		
408446.930	303.000				
Customer#000013072	13072	1481925	1998-03-15		
399195.470	301.000				
Customer#000082441	82441	857959	1994-02-07		
382579.740	305.000				
Customer#000088703	88703	2995076	1994-01-30		
363812.120	302.000				

Number of rows retrieved is: 57

Query 19

-- Query 19 - Var_0 Rev_01 - Discounted Revenue Query

Tag: Q19 Stream: -1 Sequence number: 19

```

select
sum(l_extendedprice* (1 - l_discount)) as revenue
from
tpcd.lineitem,
tpcd.part
where
(
p_partkey = l_partkey
and p_brand = 'Brand#12'
and p_container in ('SM CASE', 'SM BOX', 'SM PACK', 'SM PKG')
and l_quantity >= 1 and l_quantity <= 1 + 10
and p_size between 1 and 5
and l_shipmode in ('AIR', 'AIR REG')

```

```

and l_shipinstruct = 'DELIVER IN PERSON'
)
or
(
p_partkey = l_partkey
and p_brand = 'Brand#23'
and p_container in ('MED BAG', 'MED BOX', 'MED PKG', 'MED PACK')
and l_quantity >= 10 and l_quantity <= 10 + 10
and p_size between 1 and 10
and l_shipmode in ('AIR', 'AIR REG')
and l_shipinstruct = 'DELIVER IN PERSON'
)
or
(
p_partkey = l_partkey
and p_brand = 'Brand#34'
and p_container in ('LG CASE', 'LG BOX', 'LG PACK', 'LG PKG')
and l_quantity >= 20 and l_quantity <= 20 + 10
and p_size between 1 and 15
and l_shipmode in ('AIR', 'AIR REG')
and l_shipinstruct = 'DELIVER IN PERSON'
)

```

REVENUE

3083843.058

Number of rows retrieved is: 1

Query 20

-- Query 20 - Var_0 Rev_01 - Potential Part Promotion Query

Tag: Q20 Stream: -1 Sequence number: 4

```

select
s_name,
s_address
from
tpcd.supplier,
tpcd.nation
where
s_suppkey in (
select
ps_suppkey
from
tpcd.partsupp
where
ps_partkey in (
select
p_partkey
from
tpcd.part
where
p_name like 'forest%'
)
and ps_availqty > (
select
0.5 * sum(l_quantity)
from
tpcd.lineitem
where
l_partkey = ps_partkey
and l_suppkey = ps_suppkey
and l_shipdate >= date ('1994-01-01')
and l_shipdate < date ('1994-01-01') + 1 year
)
)
and s_nationkey = n_nationkey
and n_name = 'CANADA'

```

order by
s_name

S_NAME	S_ADDRESS
[rows deleted from output below]	
Supplier#000000020	iybAE,RmTymrZVYafZva2SH,j
Supplier#000000091	
YV45D7TtkfdQanOOZ7q9QxkyGUapU1oOWU6q3	
Supplier#000000197	YC2Acon6kjY3zj3Fbxs2k4Vdf7X0cd2F
Supplier#000000226	83qOdU2EYRdPQAQhEtn GRZEd
Supplier#000000285	Br7e1nnt1yxrw6lmgpJ7YdhFDjuBf
Supplier#000000378	FfbhyCxWvcPrO8ltp9
Supplier#000000402	i9Sw4DoyMhzhKXCH9By,AYSgmD
Supplier#000000530	0qwCMwobKY OcmLyfRXIagA8ukENJv,
Supplier#000000688	D fw5ocppmZpYBBIPI718hCihLDZ5KhKX
Supplier#000000710	f19YPvOyb QoYwjKC,oPycpGfieBAcwKJo
Supplier#000000736	
I6i2nMwVuovfKnuVgaSGK2rDy65DIAFLegil7	
Supplier#000000761	
zlSLeIQUj2XrvTTFnv7WAcYZGvMTx882d4	
Supplier#000000884	bmhEShejaS
Supplier#000000887	urEaTejH5POADP2ARrf
Supplier#000000935	ij98czM 2KzWe7dDT0xB8sq0UfCdvrx
Supplier#000000975	,AC e,tBpNwKb5xMUzeohxIRn,
hdZJo73gFQF8y	
Supplier#000001263	rQWr6nf8Zhb2TAiIDlvo5Io
Supplier#000001399	LmrocnIMSyYOWuANx7
Supplier#000001446	lch9HMNU1R7a0LLybsUodVknk6
Supplier#000001454	TOpimgu2TVXljihiL93h,
Supplier#000001500	wDmF5xLxtQch9ctVu,
Supplier#000001602	uKNWleafaM644
Supplier#000001626	UhxNRzUu1dtFmp0
Supplier#000001682	pXtKGrTQVYH1Rr
Supplier#000001699	Q9C4rfJ26oijVPqqcqVXeRl
Supplier#000001700	7hMICof1Y5zLFg
Supplier#000001726	TeRY7TtTH24sEword7yAaSkjx8
Supplier#000001730	Rc8e,1Pybn r6zo0VJIEiD0UD vhk
Supplier#000001746	
qWsendIOekQG1aW4uq06uQaCm51se8lrv7 hBRd	
Supplier#000001752	Fra7outx41THYJaRThdOGiBk
Supplier#000001856	
jXcRgzYF0ah05iR8p6w5SbJLcUGyYiURPvFwUJWM	
Supplier#000001931	FpJbMU2h6ZR2eBv8I9NlxF
Supplier#000001939	Nrk,JA4bfReUs
Supplier#000001990	
DSDJkCgBjZuPg1yuM,CUDLnsRliOxkkHezTCA	
Supplier#000002020	jB6r1d7MxP6co
Supplier#000002022	dwebGX7Id2pc25YvY33
Supplier#000002036	20ytTtVObjKUUI2WCB0A
Supplier#000002204	uYmlr46C06udCqanj0KiRsoTQakZsEyssL
Supplier#000002243	nSOEV3JeOU79
Supplier#000002245	hz2qWXWVjOyKhqPYMoEwz6zFkrTaDM
Supplier#000002282	ES21K9dxoW111TzWCj7ekdlNwSwNv1Z
6mQ,BKn	
Supplier#000002303	nCoWfpB6YOymbgOht7lftklpklHl
Supplier#000002373	RzHSxOTQmEiCjxiBiVA52Z JB58rJhPRYlR
Supplier#000002419	qydBQd14I5l5mVXa4fYY
Supplier#000002481	nLKHUOn2MI9TOA06Znq9GEMclIMO2
Supplier#000002571	JZUugz04c iJfLrlGsz90 N,W 1rVHNIReyq
Supplier#000002585	CsPoKpw2QuTY4AV1NkWuttnela4SN
Supplier#000002630	ZIQAvjNuy9KH5ive zm7k VIPiD7CCo21
Supplier#000002719	4nnzQl2CbqREQUuIsXTBVUkaP4mNS3
Supplier#000002721	HVdFAN2JHMQSpKm
Supplier#000002730	lIFxR4fzm31C6,muzJwl84z
Supplier#000002775	yDclaDaBD4ihH
Supplier#000002853	rTNAOitXka
Supplier#000002875	6JgMi 9Qt6VmwL3Ltt1SRlKww0keLQ,RAZa
Supplier#000002934	m,trBENywsARwg3DhB
Supplier#000002941	Naddba 8YTEKekZyP0
Supplier#000002960	KCPCEsRGG06vx8TygHh60nAYf9rStQt2T

Supplier#000002980 B9k9yVsyaxVwktOSHezqHiAEp9id0SKzkw
 Supplier#000003062 LSNQNgqY1xnOzz9zBCapy7HwOZQ
 Supplier#000003087 ANwe8QsZ4Rgj1HSqVz991eWQ
 Supplier#000003089 s5b VCIzQMSZVa r g7LTdgc29GbTE7r1x
 Supplier#000003095 HxON3jJhUi3zjt, r mTD
 Supplier#000003201 E87yws6l,t0qNs4QW7UzExKiJnJDZWue
 Supplier#000003213 pxrRP4irQ1VoyfQ,dTf3
 Supplier#000003241 j06SU,LS9O3mwjAMOVIANelhb
 Supplier#000003275 9xO4nyJ2QJcX6vGf
 Supplier#000003288 EDdfNt7E5Uc,xLTupolgYL4y7Ujh,
 Supplier#000003313 EI2I7we,049SPrvomUm4hZwJoOhZkvLxLJXgVH
 Supplier#000003314 jnisU8MzqO4iUB3zsPcrystMw3DDUoJ54q7LD
 Supplier#000003380 jPv0V,pszouuFT3YsAqIP,kxT3u,gTFIEbRt,x
 Supplier#000003403 e3X2o ,KCG9tsHji8A XXCxiF2hZWBw
 Supplier#000003421 Sh3dt9W5oeofFWovnfHrg,
 Supplier#000003441 zvfJlZs,oUuShHjpcX
 Supplier#000003590 sy79CMLxqb,Cbo
 Supplier#000003607 lNqFHQYjwSAkf
 Supplier#000003625 qY588W0Yk5iaUy1RXTgNrEKrMAJBYHcKs
 Supplier#000003656 eEYmmO2gmd JdfG32XtDgJv,db56
 Supplier#000003782 iVsPZg7bk06TqNMwi0LKbLURc1zmrq
 Supplier#000003918 meRvRCsJoAbfqd0Re4
 Supplier#000003941 Pmb05mQfBMS618O7WKqZJ 9vyv
 Supplier#000003994 W00LZp3NjK0
 Supplier#000004005 V723F1wCy2eA4Oglu8TjBtOVUHp
 Supplier#000004033 ncsAhv9Je,kFXTNjfb2
 Supplier#000004140 0hL7DJyYjchL
 Supplier#000004165 wTJ2dZNA8P2oi99N6DT47ndHy,XKD2
 Supplier#000004207 tf64pwiOM4IkWjN3mS,e06WuAjLx
 Supplier#000004236 dl,HPTJmGipxYsSq9wmqkuWjst,mCeJ8O6T
 Supplier#000004246 Xha aXQF7u4qU3LsHD
 Supplier#000004278 bBddbpbXlVp Di9
 Supplier#000004343 GK3sbopqrQEKLWmvVBFCG
 Supplier#000004346 S3076LEOwo
 Supplier#000004388 VfZ 11j,mwp4aS
 Supplier#000004406 Ah0ZaLu6VwufPWUz,7kbXgYZhauEaHqGlg
 Supplier#000004430 yvSsKNSTL5HLXBET4luOsPNLxKzAmk
 Supplier#000004522 xXtCKwsZDArxIBGDfzX2PgobGZsBg
 Supplier#000004527 p pVXCnxgcklWf6A1o3OHY3qW6
 Supplier#000004542 NJSbLJDroYG2y1r3rDiKg
 Supplier#000004574 1HvGwnVueZ5CIndc
 Supplier#000004655 67NqBc4 t3PG3F8aO lsqWNq4kGaPowYL
 Supplier#000004701 6jX4u47URzIMHf
 Supplier#000004711 bEzjp1QdQu lS2ERMxv0km vn6bu2zXIL1
 Supplier#000004987 UfX1upJ8MvOvgFJA8
 Supplier#000005000 DeX8w0H8FrCUvahgy ilbuzBX3NK
 Supplier#000005100 OfvYPs3lo,wEvvLHNaluCX
 Supplier#000005192 JDp4rhXiDw0kf6RH
 Supplier#000005195 Woi3b2ZaicPh ZSfu1EfXhE
 Supplier#000005283 5fxYXxwXy,TQX,MqDC2hxzyQ
 Supplier#000005300 gXG28YapxU
 Supplier#000005386 Ub6AAfHpWLWP
 Supplier#000005426 9Dz2OVT1q sb4BK71jQ1XjPBYPvO
 Supplier#000005484 saFdOR
 qW7AFY,3asPqiiAa11Mo22pCoN0BtPrKo
 Supplier#000005505 d2sbjG43KwMPX
 Supplier#000005506 On f5ypzoWgB
 Supplier#000005516 XsN99Ks9wEvcOHU6jRD2MeebQFf76mD8vovuY
 Supplier#000005536 Nzo9tGkpgbHT,EZ4D,77MYKI4ah1C
 Supplier#000005605 7Vj6eilOmThqkM
 Supplier#000005631 14TVrjIzo2SJEbYCDgpmwTlwwSqC
 Supplier#000005730 5rkb0PSews HvxkL8JaD41UpnSF2cg8H1
 Supplier#000005736 2dq XTYhtYWSfp
 Supplier#000005737 dmEWcS32C3kx,d,B95 OmYn48
 Supplier#000005797 ,o,OebwRbSDmVI9gN9fpWPCiqB UogvISR

Supplier#000005836 tx3SjPD2ZuWGFBRH,
 Supplier#000005875 IK,sYiGzB94hSyHy9xvSZFbVQNCZe2LXZuGbS
 Supplier#000005974 REhR5jE,iLusQXvf54SwYySgsSSVFHu
 Supplier#000005989 rjFY,5kgLpBu7c
 Supplier#000006059 4m0cv8MwJ9yX2vwl Z
 Supplier#000006065 Uii2Cy3W4Tu5sLk LuvXLRy6KihIgv
 Supplier#000006070 TalC5m0pDrO6DZbngfmGmqe
 Supplier#000006109 rY5gbfh3dKHnycQUTPGCwnbe
 Supplier#000006121 S92ycWwEzYYw4GspCBJN1WMuHhoZ
 Supplier#000006215 j2iEbTsl,5PWdqWZ7k1yilSb7qtiiZjDIPEo
 Supplier#000006217 RVN23SYT9jenUeaWGxUd
 Supplier#000006274 S3yTZWqxTKUq q QGgcW9
 AqhCkNZsW51hHuwU
 Supplier#000006435 xlgE69XszYbnO4Eon7cHHO8y
 Supplier#000006463 7 wkdl2EO49iotley2kmiM
 ADpLSszGV3RNWj
 Supplier#000006493 oJv f,sNaB6Hm7r,fknDVTl63raJgAjZK
 Supplier#000006521 b9 2zjHzxR
 Supplier#000006607 3F 2e2gqD5u5B
 Supplier#000006706 Ak4ga,ePu1ZQ6C3kqrqjosaX0gxvqS9vkbe
 Supplier#000006761 n4jhxGMqB5pRd1HhplvwrWstOLla
 Supplier#000006808 HGd2Xo 9nEcHJhZvXjXwWkIpaT
 Supplier#000006858 fnlINT885vBBhsWwTGiz0o22thwGy16h
 GHJj21
 Supplier#000006872 XIDPiA7PLXCWK6SeEclD
 Supplier#000006949 mlxYUJhsGcltKe ,GFirNu183AvT
 Supplier#000006985 PrUUiBoQpy,OtgJ01Z4BxJQUyrw9c3l
 Supplier#000007072 2tRyX9M1a 4Rcm57s779F1ANG9jlpK
 Supplier#000007098
 G3j8gOKC4OcbAu2OVOPhrXQWMCUdjg8wgCHOExu
 Supplier#000007135 ls DoKV7V5ulfQy9V
 Supplier#000007160 TqDGBULB3cTqIT6FKDvm9BS4e4v,zwYiQPb
 Supplier#000007169 tEc95D2moN9S84nd55O,dlnW
 Supplier#000007322 wr7dgtE5q MAJiYUuwmi3MyDkSMX1
 Supplier#000007365 51xhROLvQMj05DndtZWt
 Supplier#000007398 V8eE6oz00OFNU,
 Supplier#000007402 4UVv58ery1rjmqrS5
 Supplier#000007448 yhhpWiJi7EJ6Q5VcaQ
 Supplier#000007477 9m9j0wfhWzCvVhXkU,PpAxwSH0h
 Supplier#000007509 q8,V6LJR0hKJHcOuSG7aLTmG
 Supplier#000007561 rMcFg2530VC
 Supplier#000007789 rQ7cUcPrtudOyO3svNSkimqH6qrfWT2S2
 Supplier#000007801 69fi,U1r6enUb
 Supplier#000007818 yhhc2CQec Jrvc8zqBi83
 Supplier#000007885 u3sicch5ZpyTUpN1cJKNcAoabiWgY
 Supplier#000007918 r,v9mBQ6LoEYyj1
 Supplier#000007926 ErzCF80K9Uy
 Supplier#000007957 ELwnio24ssoU1 dRyZIL OK3Vtzb
 Supplier#000007965 F7Un5lJ7p5hhj
 Supplier#000007968
 DsF9UIZ2Fo6HXN9aErvygi1kHoD582HSGZpP
 Supplier#000007998 LnASFBfYRFOo9d6d,asBvVq9Lo2P
 Supplier#000008168 aOa82a8R0hKJcCnfDLX
 Supplier#000008231 IK7eGw Yj90sTdpS,vcqWxLB
 Supplier#000008243 2AyePMkDqmqzVzjGTizXthFlO8h
 EitudCMxOmIIG
 Supplier#000008275 BibNdFwg,gpXKQILN
 Supplier#000008323 75l18sZmASwm
 POeheRMdj9tmpyeQ,BfCXN5BIAb
 Supplier#000008366
 h778cEj14BuW9OEkIvPTWq4iwASR6EBBXN7zeS8
 Supplier#000008423 RQhKnkAhR0DAR3lx4Q1weMMn00hNe Kq
 Supplier#000008480 4sSDA4ACRekINJEm5T6b
 Supplier#000008532 Uc29q4,5xVdDOF87Uzrxhr4xWS0ihEUXuh
 Supplier#000008595 MH0iB73GQ3z UW3O DbCbqmc
 Supplier#000008610 SgVgP90vP452sUNTgzL9zKwXHXAzV6tV
 Supplier#000008705 aE,trRNdPx,4yinTD9O3DebDlp
 Supplier#000008742 HmPIQeZsKCEcTUL14,kKq

```

Supplier#000008841 | I 85Lu1sekgb2xrSlzm0
Supplier#000008895 | 2cH4okfaLSZTTg8sKRbbJQxkmeFu2Esj
Supplier#000008967 | 2kwEHYMG
7FwozNImAUE6mH0hYtqYculJM
Supplier#000008972 | w2vF6 D5YZO3visPXsqVfLADTK
Supplier#000009032 | qK,trB6Sdy4Dz1BRUFNy
Supplier#000009147 | rOAuryHxpZ9eOvx
Supplier#000009252 | F7cZaPUHwh1 ZKyj3xmAVWC1XdP
ue1p5m,i
Supplier#000009278 | RqYTzgxj93CLX 0mcYfCENOfd
Supplier#000009327 | uoqMdf7e7Gj9dbQ53
Supplier#000009430 | igRqmneFt
Supplier#000009567 | r4Wfx4c3xsEAjcGj71HHZByornl D9vrztXlv4
Supplier#000009601 | 51m637bO,Rw5DnHWFUvLacRx9
Supplier#000009709 | rRnCbHYgDgl9PZYnyWKVYSUW0vKg
Supplier#000009753 | wLhVEcRmd7PkJF4FBnGK7Z
Supplier#000009796 | z,y4ldmr15DOvPUqYG
Supplier#000009799 | 4wNjXGa4OKWI
Supplier#000009811 | E3iuyq7UnZxU7oPZle2Gu6
Supplier#000009812 | APFRMy3lCbgFga53n5t9DxzFPQPgnjrGt32
Supplier#000009862 | rJzweWeN58
Supplier#000009868 | ROjGgx5gvtkmnUUoeyy7v
Supplier#000009869 |
ucLqzrpBTRMewGSM29t0rNTM30g1Tu3Xgg3mKag
Supplier#000009899 | 7XdpAHzr1t,UQFZE
Supplier#000009974 | 7wJ,J5DKcxSU4Kp1cQLpbcAvB5AsvKT

```

Number of rows retrieved is: 204

Query 21

-- Query 21 - Var_0 Rev_01 - Suppliers Who Kept Orders Waiting
Query

Tag: Q21 Stream: -1 Sequence number: 9

```

select
s_name,
count(*) as numwait
from
tpcd.supplier,
tpcd.lineitem l1,
tpcd.orders,
tpcd.nation
where
s_suppkey = l1.l_suppkey
and o_orderkey = l1.l_orderkey
and o_orderstatus = 'F'
and l1.l_receiptdate > l1.l_commitdate
and exists (
select
*
from
tpcd.lineitem l2
where
l2.l_orderkey = l1.l_orderkey
and l2.l_suppkey <> l1.l_suppkey
)
and not exists (
select
*
from
tpcd.lineitem l3
where
l3.l_orderkey = l1.l_orderkey
and l3.l_suppkey <> l1.l_suppkey
and l3.l_receiptdate > l3.l_commitdate
)
and s_nationkey = n_nationkey
and n_name = 'SAUDI ARABIA'

```

```

group by
s_name
order by
numwait desc,
s_name
fetch first 100 rows only

```

S_NAME	NUMWAIT
Supplier#000002829	20
Supplier#000005808	18
Supplier#000000262	17
Supplier#000000496	17
Supplier#000002160	17
Supplier#000002301	17
Supplier#000002540	17
Supplier#000003063	17
Supplier#000005178	17
Supplier#000008331	17
Supplier#000002005	16
Supplier#000002095	16
Supplier#000005799	16
Supplier#000005842	16
Supplier#000006450	16
Supplier#000006939	16
Supplier#000009200	16
Supplier#000009727	16
Supplier#000000486	15
Supplier#000000565	15
Supplier#000001046	15
Supplier#000001047	15
Supplier#000001161	15
Supplier#000001336	15
Supplier#000001435	15
Supplier#000003075	15
Supplier#000003335	15
Supplier#000005649	15
Supplier#000006027	15
Supplier#000006795	15
Supplier#000006800	15
Supplier#000006824	15
Supplier#000007131	15
Supplier#000007382	15
Supplier#000008913	15
Supplier#000009787	15
Supplier#000000633	14
Supplier#000001960	14
Supplier#000002323	14
Supplier#000002490	14
Supplier#000002993	14
Supplier#000003101	14
Supplier#000004489	14
Supplier#000005435	14
Supplier#000005583	14
Supplier#000005774	14
Supplier#000007579	14
Supplier#000008180	14
Supplier#000008695	14
Supplier#000009224	14
Supplier#000000357	13
Supplier#000000436	13
Supplier#000000610	13
Supplier#000000788	13
Supplier#000000889	13
Supplier#000001062	13
Supplier#000001498	13
Supplier#000002056	13
Supplier#000002312	13
Supplier#000002344	13
Supplier#000002596	13

```

Supplier#000002615      13
Supplier#000002978      13
Supplier#000003048      13
Supplier#000003234      13
Supplier#000003727      13
Supplier#000003806      13
Supplier#000004472      13
Supplier#000005236      13
Supplier#000005906      13
Supplier#000006241      13
Supplier#000006326      13
Supplier#000006384      13
Supplier#000006394      13
Supplier#000006624      13
Supplier#000006629      13
Supplier#000006682      13
Supplier#000006737      13
Supplier#000006825      13
Supplier#000007021      13
Supplier#000007417      13
Supplier#000007497      13
Supplier#000007602      13
Supplier#000008134      13
Supplier#000008234      13
Supplier#000009435      13
Supplier#000009436      13
Supplier#000009564      13
Supplier#000009896      13
Supplier#000000379      12
Supplier#000000673      12
Supplier#000000762      12
Supplier#000000811      12
Supplier#000000821      12
Supplier#000001337      12
Supplier#000001916      12
Supplier#000001925      12
Supplier#000002039      12
Supplier#000002357      12
Supplier#000002483      12

```

Number of rows retrieved is: 100

Query 22

-- Query 22 - Var_0 Rev_01 - Global Sales Opportunity Query

Tag: Q22 Stream: -1 Sequence number: 12

```

select
c_ntrycode,
count(*) as numcust,
sum(c_acctbal) as totacctbal
from
(
select
substr(c_phone, 1, 2) as c_ntrycode,
c_acctbal
from
tpcd.customer
where
substr(c_phone, 1, 2) in
('13', '31', '23', '29', '30', '18', '17')
and c_acctbal > (
select
avg(c_acctbal)
from
tpcd.customer
where
c_acctbal > 0.00
and substr(c_phone, 1, 2) in

```

```

('13', '31', '23', '29', '30', '18', '17')
)
and not exists (
select
*
from
tpcd.orders
where
o_custkey = c_custkey
)
) as custsale
group by
c_ntrycode
order by
c_ntrycode

```

CNTRYCODE	NUMCUST	TOTACCTBAL
13	888	6737713.990
17	861	6460573.720
18	964	7236687.400
23	892	6701457.950
29	948	7158866.630
30	909	6808436.130
31	922	6806670.180

Number of rows retrieved is: 7

C.2 First 10 rows of Test Database Tables

SELECT * FROM TPCD.REGION FETCH FIRST 10 ROWS ONLY

R_REGIONKEY	R_NAME	R_COMMENT
0	AFRICA	special Tiresias about the furiously even dolphins are furi
1	AMERICA	even, ironic theodolites according to the bold platelets wa
2	ASIA	silent, bold requests sleep slyly across the quickly sly dependencies. furiously silent instructions alongside
3	EUROPE	special, bold deposits haggle foxes. platelet
4	MIDDLE EAST	furiously unusual packages use carefully above the unusual, exp

5 record(s) selected.

SELECT * FROM TPCD.NATION FETCH FIRST 10 ROWS ONLY

N_NATIONKEY	N_NAME	N_REGIONKEY	N_COMMENT
0	ALGERIA	0	final accounts wake quickly. special reques
5	ETHIOPIA	0	fluffily ruthless requests integrate fluffily. pending ideas wake blithely acco
14	KENYA	0	ironic requests boost. quickly pending pinto beans cajole slyly slyly even deposits. ironic packages
15	MOROCCO	0	ideas according to the fluffily final pinto beans sleep furiously
16	MOZAMBIQUE	0	ironic courts wake fluffily even, bold deposi

1 ARGENTINA 1 idly final instructions cajole
 stealthily. regular instructions wake carefully blithely express accounts.
 fluffi
 2 BRAZIL 1 always pending pinto beans sleep
 sil
 3 CANADA 1 foxes among the bold requests
 17 PERU 1 final, final accounts sleep slyly
 across the requests.
 24 UNITED STATES 1 blithely regular deposits
 serve furiously blithely regular warthogs! slyly fi
 10 record(s) selected.

SELECT * FROM TPCD.PART FETCH FIRST 10 ROWS ONLY

P_PARTKEY	P_NAME	P_MFGR
P_BRAND	P_TYPE	P_SIZE
P_RETAILPRICE	P_COMMENT	P_CONTAINER
43	medium khaki chocolate rosy blush	Manufacturer#4
Brand#44	PROMO POLISHED STEEL	5
WRAP CASE	+9.4304000000000E+002 carefully iro	
89	ghost khaki lawn pale dim	Manufacturer#5
Brand#53	STANDARD BURNISHED STEEL	7 MED JAR
+9.8908000000000E+002	quickly ironi	
98	frosted goldenrod chartreuse dark honeydew	Manufacturer#5
Brand#54	STANDARD ANODIZED BRASS	
22 MED JAR	+9.9809000000000E+002 furiou	
122	ghost royal chocolate peach ivory	Manufacturer#2
Brand#21	MEDIUM ANODIZED TIN	8 LG
DRUM	+1.0221200000000E+003 pinto beans w	
144	wheat brown orange almond aquamarine	Manufacturer#1
Brand#14	SMALL ANODIZED TIN	26 SM
BOX	+1.0441400000000E+003 blithely bold r	
169	tan lime sky almond midnight	Manufacturer#5
Brand#55	STANDARD POLISHED BRASS	10
JUMBO CASE	+1.0691600000000E+003 blithely	
178	blue black cornflower white powder	Manufacturer#1
Brand#13	STANDARD POLISHED TIN	10 LG
JAR	+1.0781700000000E+003 pending pearls sleep	
232	ivory purple spring tan cornsilk	Manufacturer#5
Brand#53	LARGE BURNISHED NICKEL	50 SM PKG
+1.1322300000000E+003	quick deposits enga	
242	magenta deep lawn linen navy	Manufacturer#3
Brand#35	SMALL POLISHED STEEL	42 LG
BAG	+1.1422400000000E+003 final pearls wake b	
244	midnight brown magenta maroon tan	Manufacturer#5
Brand#51	ECONOMY BURNISHED BRASS	48
LG BOX	+1.1442400000000E+003 careful	

10 record(s) selected.

SELECT * FROM TPCD.SUPPLIER FETCH FIRST 10 ROWS ONLY

S_SUPPKEY	S_NAME	S_ADDRESS
S_NATIONKEY	S_PHONE	S_COMMENT
474	Supplier#000000474	USHBMdX8iFodU
0 10-327-319-7717	+5.2262100000000E+003	pending, express courts along the carefully express accounts use quickly final instr
1311	Supplier#000001311	
RkSRZhG0WUBlvJSU1X9js0hOmf6SL6b1hmKW4bf	0 10-472-262-9154	-8.0577000000000E+002 slyly regular platelets cajole. pending packages haggle blithely regular packag

1878 Supplier#000001878 IXQbu8BN2TgGS
 0 10-903-990-3612 +9.2702600000000E+003 ironic, final esca-
 pades wake blithely among the regular
 6559 Supplier#000006559 wQXd8ML1z7KsEz,KUTpFmU
 0 10-175-586-1002 +3.6684000000000E+002 theodolites use. furi-
 ously f
 8379 Supplier#000008379 Ge-
 HYbtj.EQacbKAWsyZ7SiH5BJ7cY6Pq 0 10-247-201-5353
 +3.5586100000000E+003 ironic instructions cajole. stealthy f
 8814 Supplier#000008814 G64p9bmN4IEar1sbb65
 0 10-274-747-4283 +1.3014700000000E+003 blithely bold courts
 cajole silent request
 9358 Supplier#000009358 Ds5FfdEuXPXVjjRGeq
 0 10-374-899-2706 +7.0544900000000E+003 regular packages
 solve after the furious, unusual deposits. bold dependencies are f
 9714 Supplier#000009714 v9KJ,mGzvaEL9iAT
 112ZJT4rKcOew 0 10-347-780-2647
 +5.8646000000000E+003 carefully bold requests engage fluffily. furi-
 ously bold instructions sleep. pend
 10406 Supplier#000010406 5GFuCsTjoBwc
 0 10-465-671-6896 +4.5713400000000E+003 blithely unusual in-
 structions haggle. silent theodolites hang deposits. slyly silent g
 11613 Supplier#000011613 imor,wc1nK42SV5iMX9 R
 0 10-565-356-4350 +3.0208600000000E+003 blithely enticing pack-
 ages haggle slyly. accounts x-ray finally. furiously unusual ins
 10 record(s) selected.

SELECT * FROM TPCD.PARTSUPP FETCH FIRST 10 ROWS ONLY

PS_PARTKEY	PS_SUPPKEY	PS_AVAILQTY	PS_SUPPLYCOST	PS_COMMENT
43	44	3211	+8.0578000000000E+002	final, express dependencies sleep according to the express requests. bold, regular accounts detect outside the slyly
43	2500044	6770	+4.9319000000000E+002	furiously special pinto beans cajole. ironic decoys across the
43	5000044	9506	+4.9365000000000E+002	carefully fluffy accounts across the blithely final accounts hang slyly according to the furiously special platelets. sil
43	7500044	3232	+3.0712000000000E+002	bold packages wake blithely above the furiously bold
89	90	3430	+7.4487000000000E+002	boldly silent theodolites grow carefully furiously special platelets. packages cajole fluffily foxes. slyly special ideas against the slyly unusual packages
89	2500090	8599	+7.7653000000000E+002	blithely even deposits integrate blithely about the furiously regular pains. special account
89	5000090	7876	+4.1761000000000E+002	final foxes sleep fluffily regular packages. fluffily pending platelets sleep never against the slyly bold packages. slyly unusual foxes among the quickly fina
89	7500090	924	+9.2002000000000E+002	blithely regular ideas wake carefully. quickly regular sheaves wake
98	99	9486	+9.0821000000000E+002	deposits haggle busily express deposits. furiously blithe platelets
98	2500099	8550	+6.5716000000000E+002	express, final deposits haggle along the regular foxes. carefully regular excuses wake against the carefully even pinto beans. furiously express pinto beans

10 record(s) selected.

SELECT * FROM TPCD.CUSTOMER FETCH FIRST 10 ROWS ONLY

C_CUSTKEY C_NAME C_ADDRESS
 C_NATIONKEY C_PHONE C_ACCTBAL
 C_MKTSEGMENT C_COMMENT

 43 Customer#000000043
 ouSbjHk8lh5fKX3zGso3ZSj9Aa3PoaFd 19 29-316-665-
 2897 +9.90428000000000E+003 MACHINERY idly regular senti-
 ments affix. slyly pending foxes around the deposits haggle according
 to th

89 Customer#000000089 dtR, y9JQWUO6FoJExyp8whOU
 14 24-394-451-5404 +1.53076000000000E+003 FURNITURE bold
 accounts cajole furiously after the permanently even excuses. ac-
 counts cajole. fluffily even requ

98 Customer#000000098 7yiheXNSpuEAwbswDW
 12 22-885-845-6889 -5.51370000000000E+002 BUILDING blithely
 final foxes along the unusual realms detect accounts. idle theodolites
 use pinto beans. ev

122 Customer#000000122
 yp5sloNd26IAENZW3a67wSfXA6hTF 3 13-702-694-4520
 +7.86546000000000E+003 HOUSEHOLD furiously regular instruc-
 tions cajole furiously ideas. quickly bold foxes wake careful

144 Customer#000000144
 VxYZ3ebhgltnetaGjNC8qCccjYU05 fePLOno8y 1 11-717-379-
 4478 +6.41731000000000E+003 MACHINERY fluffily regular re-
 quests at the blithely even theodolites haggle around the requests.
 special frets x-

169 Customer#000000169 NjhmHa7xrcjE
 18 28-362-499-3728 +4.48383000000000E+003 FURNITURE furi-
 ously pending dugouts use furiously unusual, regular deposits. care-
 fully regul

178 Customer#000000178 p
 HUSDg8Cgan4Fj8Drvczd4gi4dSqV0a7n 0ag 21 31-436-268-
 6327 +2.27250000000000E+003 FURNITURE blithely express
 pinto beans do haggle. slyly ironic deposits wake carefully about the fin

232 Customer#000000232
 oA9o.3YOXu2rzKONdd.cxpqCFXUv5kuxBYKp 22 32-283-563-
 2674 +5.54710000000000E+002 HOUSEHOLD ideas eat furiously
 carefully special instructions

242 Customer#000000242
 apgzK3HWAjKHFteJ16Tg3OERViesqBbx 3 13-324-350-
 3564 +1.97541000000000E+003 MACHINERY carefully express
 ideas nag final requests. slyly daring accounts cajole slyly blithely pend

244 Customer#000000244
 FBVbCpEVaFaP8KogqQO2VuXeVx 15 25-621-225-
 8173 +2.50638000000000E+003 HOUSEHOLD blithely silent re-
 quests are quickly along t

10 record(s) selected.

SELECT * FROM TPCD.ORDERS FETCH FIRST 10 ROWS ONLY

O_ORDERKEY O_CUSTKEY O_ORDERSTATUS
 O_TOTALPRICE O_ORDERDATE O_ORDERPRIORITY
 O_CLERK O_SHIPRIORITY O_COMMENT

 368004 115312861 F +9.62985700000000E+004
 01/01/1992 2-HIGH Clerk#000644454 0 slyly unusual
 theodolites snooze pending instructions! q
 560930 25046506 F +2.62145760000000E+005
 01/01/1992 3-MEDIUM Clerk#000017603 0 pinto beans
 use carefully quickly ironic foxes! carefully ironic
 682656 83852087 F +1.84822640000000E+005
 01/01/1992 5-LOW Clerk#000795342 0 silent ideas
 doubt along the careful

779654 32491363 F +1.31404100000000E+005
 01/01/1992 5-LOW Clerk#000770223 0 final platelets
 snooze above t
 1054181 139420987 F +1.92793400000000E+005
 01/01/1992 5-LOW Clerk#000469323 0 final accounts
 dazzle quickly. even acco
 1249954 37416013 F +1.71866550000000E+005
 01/01/1992 2-HIGH Clerk#000383087 0 furiously ex-
 press pinto beans sleep closely! slyly
 1555776 120413194 F +4.43426000000000E+004
 01/01/1992 3-MEDIUM Clerk#000555212 0 carefully un-
 usual reque
 3138151 95707111 F +1.80085560000000E+005
 01/01/1992 5-LOW Clerk#000342117 0 furiously bold
 packages sleep slyly even, special accounts
 4905731 47075614 F +7.02759000000000E+004
 01/01/1992 1-URGENT Clerk#000786750 0 quickly ironic
 deposits cajol
 5018977 104147872 F +7.61296900000000E+004
 01/01/1992 2-HIGH Clerk#000451800 0 ironic requests
 wake carefully: quickly bold accounts cajole reques

10 record(s) selected.

SELECT * FROM TPCD.LINEITEM FETCH FIRST 10 ROWS ONLY

L_ORDERKEY L_PARTKEY L_SUPPKEY L_LINENUMBER
 L_QUANTITY L_EXTENDEDPRICE L_DISCOUNT
 L_TAX L_RETURNFLAG L_LINESTATUS L_SHIPDATE
 L_COMMITDATE L_RECEIPTDATE L_SHIPINSTRUCT
 L_SHIPMODE L_COMMENT

 842980 188155842 5655897 4
 +5.00000000000000E+000 +9.44220000000000E+003
 +1.00000000000000E-002 +3.00000000000000E-002 A F
 01/02/1992 03/20/1992 01/20/1992 COLLECT COD REG
 AIR blithely ironic deposits cajole qui
 16214466 192988558 5488578 1
 +5.00000000000000E+000 +8.18455000000000E+003
 +0.00000000000000E+000 +0.00000000000000E+000 R F
 01/02/1992 03/13/1992 01/22/1992 NONE MAIL
 furiously slow dolphins boos
 30467136 151584977 1584978 1
 +4.90000000000000E+001 +1.00665600000000E+005
 +2.00000000000000E-002 +1.00000000000000E-002 R F
 01/02/1992 03/15/1992 01/26/1992 TAKE BACK RETURN
 SHIP regular, ironic deposits doze blithel
 37087616 29604236 4604241 4
 +2.30000000000000E+001 +2.61912500000000E+004
 +6.00000000000000E-002 +1.00000000000000E-002 A F
 01/02/1992 03/21/1992 01/05/1992 TAKE BACK RETURN
 AIR stealthily special c
 40583460 136619135 9119149 3
 +4.50000000000000E+001 +4.71285000000000E+004
 +8.00000000000000E-002 +4.00000000000000E-002 A F
 01/02/1992 03/31/1992 01/30/1992 COLLECT COD RAIL
 blithely dogged re
 44722882 32437674 2437675 1
 +3.10000000000000E+001 +4.99115500000000E+004
 +1.00000000000000E-002 +0.00000000000000E+000 R F
 01/02/1992 03/22/1992 01/12/1992 TAKE BACK RETURN
 RAIL silent deposi
 49490369 127042005 2042030 7
 +3.20000000000000E+001 +3.01008000000000E+004
 +2.00000000000000E-002 +4.00000000000000E-002 A F

```

01/02/1992 03/31/1992 01/16/1992 NONE          FOB
permanent requests are
    70652288 137300110 2300137      4
+4.500000000000000E+001 +4.964625000000000E+004
+1.000000000000000E-002 +4.000000000000000E-002 A    F
01/02/1992 02/29/1992 01/20/1992 TAKE BACK RETURN
RAIL  foxes sleep carefully about the slyly p
    82791749 76911477 1911492      2
+9.000000000000000E+000 +1.336167000000000E+004
+6.000000000000000E-002 +5.000000000000000E-002 A    F
01/02/1992 02/19/1992 01/29/1992 TAKE BACK RETURN
TRUCK  fluffily enticing pin
    82791749 51183576 8683592      3
+3.200000000000000E+001 +5.302464000000000E+004
+3.000000000000000E-002 +3.000000000000000E-002 R    F
01/02/1992 03/16/1992 01/12/1992 NONE          SHIP
slyly dogged requests dazzle carefully req

```

10 record(s) selected.

C.3 Query Substitution Parameters

Power stream Seed = 906020938
-- TPC TPC-H Parameter Substitution (Version 2.1.1b)
-- using 906020938 as a seed to the RNG

```

Q1 DELTA      71
Q2 SIZE      39
  TYPE      TIN
  REGION    AFRICA
Q3 SEGMENT    HOUSEHOLD
  DATE      1995-03-06
Q4 DATE      1993-12-01
Q5 REGION    AMERICA
  DATE      1994-01-01
Q6 DATE      1994-01-01
  DISCOUNT 0.06
  QUANTITY  25
Q7 NATION1   JORDAN
  NATION2   ROMANIA
Q8 NATION    ROMANIA
  REGION    EUROPE
  TYPE      SMALL BRUSHED STEEL
Q9 COLOR     frosted
Q10 DATE     1995-01-01
Q11 NATION   MOROCCO
  FRACTION  0.0000001000
Q12 SHIPMODE1 RAIL
  SHIPMODE2 REG AIR
  DATE      1996-01-01
Q13 WORD1    special
  WORD2     accounts
Q14 DATE     1996-09-01
Q15 DATE     1993-03-01
Q16 BRAND    Brand#35
  TYPE      LARGE BURNISHED
  SIZE1     37
  SIZE2     10
  SIZE3     3
  SIZE4     7
  SIZE5     40
  SIZE6     31
  SIZE7     21
  SIZE8     30
Q17 BRAND    Brand#53
  CONTAINER JUMBO PKG
Q18 QUANTITY 314
Q19 BRAND1   Brand#41
  BRAND2     Brand#13
  BRAND3     Brand#45
  QUANTITY1  4

```

```

QUANTITY2 16
QUANTITY3 26
Q20 COLOUR coral
  DATE     1993-01-01
  NATION   IRAN
Q21 NATION ARGENTINA
Q22 I1     20
  I2       27
  I3       17
  I4       15
  I5       30
  I6       32
  I7       13

```

Throughput Stream = 1 Seed = 906020939
-- TPC TPC-H Parameter Substitution (Version 2.1.1b)
-- using 906020939 as a seed to the RNG

```

Q1 DELTA      79
Q2 SIZE      27
  TYPE      COPPER
  REGION    EUROPE
Q3 SEGMENT    AUTOMOBILE
  DATE      1995-03-22
Q4 DATE      1996-07-01
Q5 REGION    ASIA
  DATE      1994-01-01
Q6 DATE      1994-01-01
  DISCOUNT 0.03
  QUANTITY  24
Q7 NATION1   ETHIOPIA
  NATION2   IRAQ
Q8 NATION    IRAQ
  REGION    MIDDLE EAST
  TYPE      SMALL PLATED STEEL
Q9 COLOR     dim
Q10 DATE     1993-10-01
Q11 NATION   CANADA
  FRACTION  0.0000001000
Q12 SHIPMODE1 AIR
  SHIPMODE2 REG AIR
  DATE      1996-01-01
Q13 WORD1    special
  WORD2     deposits
Q14 DATE     1997-01-01
Q15 DATE     1995-10-01
Q16 BRAND    Brand#15
  TYPE      PROMO PLATED
  SIZE1     25
  SIZE2     30
  SIZE3     37
  SIZE4     3
  SIZE5     32
  SIZE6     22
  SIZE7     43
  SIZE8     34
Q17 BRAND    Brand#55
  CONTAINER WRAP CASE
Q18 QUANTITY 315
Q19 BRAND1   Brand#53
  BRAND2     Brand#41
  BRAND3     Brand#44
  QUANTITY1  9
  QUANTITY2  17
  QUANTITY3  22
Q20 COLOUR   moccasin
  DATE      1996-01-01
  NATION    ALGERIA
Q21 NATION   CHINA
Q22 I1       13
  I2         25

```

I3 19
I4 31
I5 26
I6 16
I7 22

Throughput Stream = 2 Seed = 906020940
-- TPC TPC-H Parameter Substitution (Version 2.1.1b)

-- using 906020940 as a seed to the RNG

Q1 DELTA 87
Q2 SIZE 15
TYPE STEEL
REGION AMERICA
Q3 SEGMENT HOUSEHOLD
DATE 1995-03-08
Q4 DATE 1994-03-01
Q5 REGION MIDDLE EAST
DATE 1995-01-01
Q6 DATE 1995-01-01
DISCOUNT 0.09
QUANTITY 24
Q7 NATION1 RUSSIA
NATION2 CANADA
Q8 NATION CANADA
REGION AMERICA
TYPE SMALL ANODIZED STEEL
Q9 COLOR cornflower
Q10 DATE 1994-07-01
Q11 NATION MOZAMBIQUE
FRACTION 0.0000001000
Q12 SHIPMODE1 SHIP
SHIPMODE2 REG AIR
DATE 1997-01-01
Q13 WORD1 special
WORD2 deposits
Q14 DATE 1997-04-01
Q15 DATE 1993-06-01
Q16 BRAND Brand#55
TYPE SMALL BRUSHED
SIZE1 2
SIZE2 12
SIZE3 21
SIZE4 30
SIZE5 42
SIZE6 27
SIZE7 20
SIZE8 32
Q17 BRAND Brand#52
CONTAINER WRAP BAG
Q18 QUANTITY 313
Q19 BRAND1 Brand#51
BRAND2 Brand#33
BRAND3 Brand#33
QUANTITY1 4
QUANTITY2 18
QUANTITY3 29
Q20 COLOUR antique
DATE 1995-01-01
NATION KENYA
Q21 NATION IRAN
Q22 I1 11
I2 10
I3 16
I4 19
I5 29
I6 32
I7 18

Throughput Stream = 3 Seed = 906020941
-- TPC TPC-H Parameter Substitution (Version 2.1.1b)

-- using 906020941 as a seed to the RNG

Q1 DELTA 96
Q2 SIZE 2
TYPE BRASS
REGION EUROPE
Q3 SEGMENT AUTOMOBILE
DATE 1995-03-24
Q4 DATE 1996-10-01
Q5 REGION AFRICA
DATE 1995-01-01
Q6 DATE 1995-01-01
DISCOUNT 0.06
QUANTITY 25
Q7 NATION1 KENYA
NATION2 SAUDI ARABIA
Q8 NATION SAUDI ARABIA
REGION MIDDLE EAST
TYPE STANDARD POLISHED STEEL
Q9 COLOR burlywood
Q10 DATE 1993-04-01
Q11 NATION EGYPT
FRACTION 0.0000001000
Q12 SHIPMODE1 FOB
SHIPMODE2 REG AIR
DATE 1997-01-01
Q13 WORD1 special
WORD2 deposits
Q14 DATE 1997-07-01
Q15 DATE 1996-01-01
Q16 BRAND Brand#35
TYPE ECONOMY ANODIZED
SIZE1 47
SIZE2 40
SIZE3 6
SIZE4 27
SIZE5 25
SIZE6 20
SIZE7 35
SIZE8 9
Q17 BRAND Brand#54
CONTAINER WRAP PKG
Q18 QUANTITY 314
Q19 BRAND1 Brand#53
BRAND2 Brand#11
BRAND3 Brand#32
QUANTITY1 10
QUANTITY2 19
QUANTITY3 26
Q20 COLOUR khaki
DATE 1993-01-01
NATION EGYPT
Q21 NATION BRAZIL
Q22 I1 14
I2 33
I3 19
I4 12
I5 29
I6 27
I7 25

Throughput Stream = 4 Seed = 906020942
-- TPC TPC-H Parameter Substitution (Version 2.1.1b)

-- using 906020942 as a seed to the RNG

Q1 DELTA 104
Q2 SIZE 40
TYPE NICKEL
REGION AMERICA
Q3 SEGMENT FURNITURE
DATE 1995-03-10
Q4 DATE 1994-07-01

Q5 REGION AMERICA
 DATE 1995-01-01
 Q6 DATE 1995-01-01
 DISCOUNT 0.04
 QUANTITY 25
 Q7 NATION1 FRANCE
 NATION2 JAPAN
 Q8 NATION JAPAN
 REGION ASIA
 TYPE STANDARD BURNISHED COPPER
 Q9 COLOR bisque
 Q10 DATE 1994-02-01
 Q11 NATION PERU
 FRACTION 0.0000001000
 Q12 SHIPMODE1 MAIL
 SHIPMODE2 AIR
 DATE 1997-01-01
 Q13 WORD1 special
 WORD2 deposits
 Q14 DATE 1997-10-01
 Q15 DATE 1993-10-01
 Q16 BRAND Brand#15
 TYPE STANDARD PLATED
 SIZE1 1
 SIZE2 29
 SIZE3 16
 SIZE4 39
 SIZE5 41
 SIZE6 12
 SIZE7 27
 SIZE8 8
 Q17 BRAND Brand#51
 CONTAINER SM CASE
 Q18 QUANTITY 312
 Q19 BRAND1 Brand#15
 BRAND2 Brand#44
 BRAND3 Brand#32
 QUANTITY1 5
 QUANTITY2 20
 QUANTITY3 22
 Q20 COLOUR sky
 DATE 1996-01-01
 NATION ROMANIA
 Q21 NATION ROMANIA
 Q22 I1 25
 I2 30
 I3 15
 I4 14
 I5 16
 I6 24
 I7 10

Throughput Stream = 5 Seed = 906020943
 -- TPC TPC-H Parameter Substitution (Version 2.1.1b)
 -- using 906020943 as a seed to the RNG
 Q1 DELTA 112
 Q2 SIZE 28
 TYPE COPPER
 REGION MIDDLE EAST
 Q3 SEGMENT AUTOMOBILE
 DATE 1995-03-27
 Q4 DATE 1997-02-01
 Q5 REGION ASIA
 DATE 1995-01-01
 Q6 DATE 1995-01-01
 DISCOUNT 0.09
 QUANTITY 24
 Q7 NATION1 UNITED KINGDOM
 NATION2 EGYPT
 Q8 NATION EGYPT

REGION MIDDLE EAST
 TYPE PROMO BRUSHED COPPER
 Q9 COLOR yellow
 Q10 DATE 1994-11-01
 Q11 NATION ETHIOPIA
 FRACTION 0.0000001000
 Q12 SHIPMODE1 TRUCK
 SHIPMODE2 AIR
 DATE 1997-01-01
 Q13 WORD1 special
 WORD2 deposits
 Q14 DATE 1998-01-01
 Q15 DATE 1996-05-01
 Q16 BRAND Brand#55
 TYPE MEDIUM POLISHED
 SIZE1 4
 SIZE2 25
 SIZE3 8
 SIZE4 6
 SIZE5 22
 SIZE6 19
 SIZE7 49
 SIZE8 12
 Q17 BRAND Brand#53
 CONTAINER SM BAG
 Q18 QUANTITY 313
 Q19 BRAND1 Brand#12
 BRAND2 Brand#32
 BRAND3 Brand#21
 QUANTITY1 10
 QUANTITY2 10
 QUANTITY3 29
 Q20 COLOUR dodger
 DATE 1995-01-01
 NATION INDONESIA
 Q21 NATION IRAQ
 Q22 I1 17
 I2 14
 I3 28
 I4 34
 I5 22
 I6 33
 I7 11

Throughput Stream = 6 Seed = 906020944
 -- TPC TPC-H Parameter Substitution (Version 2.1.1b)
 -- using 906020944 as a seed to the RNG
 Q1 DELTA 120
 Q2 SIZE 16
 TYPE STEEL
 REGION AMERICA
 Q3 SEGMENT FURNITURE
 DATE 1995-03-12
 Q4 DATE 1994-11-01
 Q5 REGION EUROPE
 DATE 1995-01-01
 Q6 DATE 1995-01-01
 DISCOUNT 0.07
 QUANTITY 25
 Q7 NATION1 MOROCCO
 NATION2 VIETNAM
 Q8 NATION VIETNAM
 REGION ASIA
 TYPE PROMO PLATED COPPER
 Q9 COLOR thistle
 Q10 DATE 1993-08-01
 Q11 NATION CHINA
 FRACTION 0.0000001000
 Q12 SHIPMODE1 RAIL
 SHIPMODE2 AIR

DATE 1993-01-01
 Q13 WORD1 special
 WORD2 packages
 Q14 DATE 1993-05-01
 Q15 DATE 1994-01-01
 Q16 BRAND Brand#35
 TYPE PROMO ANODIZED
 SIZE1 7
 SIZE2 35
 SIZE3 9
 SIZE4 2
 SIZE5 15
 SIZE6 47
 SIZE7 39
 SIZE8 25
 Q17 BRAND Brand#55
 CONTAINER SM PKG
 Q18 QUANTITY 315
 Q19 BRAND1 Brand#14
 BRAND2 Brand#15
 BRAND3 Brand#25
 QUANTITY1 5
 QUANTITY2 11
 QUANTITY3 25
 Q20 COLOUR peru
 DATE 1993-01-01
 NATION UNITED KINGDOM
 Q21 NATION EGYPT
 Q22 I1 33
 I2 19
 I3 10
 I4 32
 I5 18
 I6 23
 I7 34

SIZE2 2
 SIZE3 36
 SIZE4 14
 SIZE5 16
 SIZE6 38
 SIZE7 18
 SIZE8 31
 Q17 BRAND Brand#52
 CONTAINER LG CASE
 Q18 QUANTITY 312
 Q19 BRAND1 Brand#21
 BRAND2 Brand#53
 BRAND3 Brand#24
 QUANTITY1 1
 QUANTITY2 12
 QUANTITY3 21
 Q20 COLOUR blush
 DATE 1997-01-01
 NATION JORDAN
 Q21 NATION VIETNAM
 Q22 I1 17
 I2 15
 I3 18
 I4 21
 I5 34
 I6 12
 I7 20

Throughput Stream = 7 Seed = 906020945
 -- TPC TPC-H Parameter Substitution (Version 2.1.1b)
 -- using 906020945 as a seed to the RNG

Q1 DELTA 67
 Q2 SIZE 4
 TYPE BRASS
 REGION MIDDLE EAST
 Q3 SEGMENT MACHINERY
 DATE 1995-03-29
 Q4 DATE 1997-06-01
 Q5 REGION MIDDLE EAST
 DATE 1996-01-01
 Q6 DATE 1996-01-01
 DISCOUNT 0.04
 QUANTITY 25
 Q7 NATION1 GERMANY
 NATION2 JORDAN
 Q8 NATION JORDAN
 REGION MIDDLE EAST
 TYPE PROMO ANODIZED COPPER
 Q9 COLOR slate
 Q10 DATE 1994-05-01
 Q11 NATION FRANCE
 FRACTION 0.0000001000
 Q12 SHIPMODE1 AIR
 SHIPMODE2 REG AIR
 DATE 1996-01-01
 Q13 WORD1 pending
 WORD2 packages
 Q14 DATE 1993-08-01
 Q15 DATE 1996-08-01
 Q16 BRAND Brand#15
 TYPE SMALL BURNISHED
 SIZE1 5

Appendix - D

Driver Source Code

D.1 tpcdbatch.h

```
/** Necessary header files */
/** System header files */
#include <stdio.h>
#include <stdlib.h>
#include <string.h>
#include <math.h>
#include <fcntl.h>          /* SUN bbe */

#include <time.h>
#include <ctype.h>
#if (defined(SQLAIX) || defined(SQLPTX) || defined(LINUX) ||
defined(SQLHP))
#include <unistd.h>        /* SUN */
#include <sys/stat.h>      /* SUN */
#endif
#if ((defined(SQLAIX) || defined(SQLPTX)) && !defined(LINUX))
#include <sys/vnode.h>     /* SUN */
#endif
#ifndef SQLWINT
#include <sys/time.h>      /* @d33143aha */
#include <sys/ipc.h>
#include <sys/sem.h>
#if (!defined(SQLPTX) && !defined(LINUX) && !defined(SQLHP))
#include <sys/mode.h>
#endif
#include <sys/timeb.h>
#include <sys/types.h>
#else
#include <windows.h>
#include <sys\timeb.h>
#endif
#include <errno.h>

/** External header files */
#include "sqlda.h"
#include "sqlenv.h"
#include "sql.h"
#include "sqlmon.h"
#include "sqlca.h"
#include "sqlutil.h"
#include "sqlcodes.h"

/** Internal header files */
/** #ifdef __cplusplus */
/** #include "sqlz.h" */
/** #include "sqlzcopy.h" */
/** #endif */

/*****
/* Define synonyms here */
/*****
#define TPCDBATCH_VERSION "5.6"

#define TPCDBATCH_NONSQL 10          /* @d23684
tjg */
#define TPCDBATCH_SELECT 20
#define TPCDBATCH_NONSELECT 30
#define TPCDBATCH_EOBLOCK 40       /* @d30369
tjg */
```

```
#define TPCDBATCH_INSERT 50
#define TPCDBATCH_DELETE 60

#define TPCDBATCH_MAX_COLS 100     /*
@d30369 tjg */

#define TPCDBATCH_CHAR char

#define TPCDBATCH_PRINT_FLOAT_WIDTH 20
/* kmw - allow 15 whole digit for %#.3f format */
/* - note: use > 18, size of long identifier so that it will */
/* be larger than any column heading */
#define TPCDBATCH_PRINT_FLOAT_MAX 1e15 /* kmw */
/* #define TPCD_PREPARETIME 1 */ /* for separate prep/exec on
uf jen 1106 */

#ifndef SQLWINT
#define PATH_DELIM '\\'
#define sleep(a) Sleep((a)*1000)
#else
#define PATH_DELIM '/'
#endif

#define PARALLEL_UPDATES 1

#ifndef PARALLEL_UPDATES
#define UF1OUTSTREAMPATTERN "%s%cuf1.%02d.%d.out"
#define TPCD_NONPARTITIONED
#define UF2OUTSTREAMPATTERN "%s%cuf2.%02d.%d.out"
#else
/* kelly add same as NONPART. */
#define UF2OUTSTREAMPATTERN "%s%cuf2.%02d.%d.out"
/* kelly ... take this out ... should be same name as non-partitioned
#define UF2OUTSTREAMPATTERN "%s%cuf2.%02d.%d.%d.out" */
/* DELjen add delchunk */
#endif
#define BUFSIZE 1024
#endif

#define T_STAMP_FORM_1 1
#define T_STAMP_FORM_2 2
/* jen TIME_ACC start */
#define T_STAMP_FORM_3 3
#define T_STAMP_1LEN 17
#if defined (SQLUNIX) || defined (SQLAIX)
#define T_STAMP_3LEN 24
#elif (defined (SQLDOS2) || defined (SQLWINT) || defined (SQLWIN) ||
defined (SQLDOS))
#define T_STAMP_3LEN 21 /* WIN NT timestamp fix bbe */
#else
#error Unknown operating system
#endif
/* jen TIME_ACC start */

#define BLANKS "\0"
#define READMODE "r\0"
#define WRITEMODE "w\0"
#define APPENDMODE "a\0"
#define mem_error(xx) \
{ fprintf(stderr, "\n--Out of memory when %s.\n", xx); }
/* Display out-of-memory and end */

#define TPCDBATCH_MIN(x,y) ((x) < (y) ? (x) : (y))
/** Returns the smaller of both x and y */
#define TPCDBATCH_MAX(x,y) ((x) > (y) ? (x) : (y)) /*
@d22817 tjg */
/** Returns the larger of both x and y */
```

```

/** Defines needed for decimal conversion */
#define SQLZ_DYNLINK
#define TRUE 1
#define LEFT 1
#define RIGHT 0
#define FALSE 0
#define sqlrx_get_left_nibble(byte) (((unsigned char)(byte)) >> 4)

#define sqlrx_get_right_nibble(byte) ((unsigned char) (byte & '\x0f'))
#define SQL_MAXDECIMAL 31
#define SQLRX_PREFERRED_PLUS 0x0c

/** Timer-necessary defines for portability */
#if (defined (SQLOS2) || defined (SQLWINT)) || defined (SQLWIN) ||
defined (SQLDOS)
typedef struct timeb Timer_struct;
#elif (defined (SQLUNIX) || defined (SQLAIX)) /*TIMER jen*/
typedef struct timeval Timer_struct;
#else
#error Unknown operating system
#endif

/* sleep time between starting subsequent tpcdbatches running UF1
and UF2 */
#define UF1_SLEEP 1
#define UF2_SLEEP 1
#define UF_DEADLOCK_SLEEP 1 /* sleep between deadlock retries
in UF1,UF2 */

#define MAXWAIT 50 /* maximum retries for deadlock encounters */

#define DEBUG 0 /* to be set to 1 for diagnostic purposes if needed
*/
/* #define UF1DEBUG 1 */
/* #define UF2DEBUG 1 */

```

D.2 tpcdbatch.sqc

```

/* included in tpcdbatch.sqc and tpcdUF.sqc */

#include "tpcdbatch.h"

/*****
/* global structure containing elements passed between different
functions */
/*****
struct global_struct
{
    struct stmt_info *s_info_ptr; /* ptr to stmt_info list */
    struct stmt_info *s_info_stop_ptr; /* ptr to last struct in list */
    struct comm_line_opt *c_l_opt; /* ptr to comm_line_opt struct
*/
    struct ctrl_flags *c_flags; /* ptr to ctrl_flags struct */
    Timer_struct stream_start_time; /* start time for stream
TIME_ACC */
    Timer_struct stream_end_time; /* end time for stream
TIME_ACC */
    char file_time_stamp[50]; /* time stamp for output files */
    double scale_factor; /* scale factor of database */
    char run_dir[150]; /* directory for output files */
    int copy_on_load; /* indication of whether or not */
/* to do use a copy directory */
/* (equiv to COPY YES) on load */
/* default is FALSE */
    long lSeed; /* seed used to generate the */
/* queries for this particular */
/* run. */
}

```

```

FILE *stream_list; /* ptr to query list file */
char update_num_file[150]; /* name of file that keeps track
*/
/* of which update pairs have run*/
char sem_file[150]; /* semaphore name */
char sem_file2[150]; /* semaphore name bbe */
FILE *stream_report_file; /* file to report start stop */
/* progress of the stream */
};

/*****
/* New type declaration to store details about SQL statement */
/*****
struct stmt_info
{
    long max_rows_fetch;
    long max_rows_out;
    int query_block; /* @d30369 tjq */
    unsigned int stmt_num; /* @d24993 tjq */
    double elapse_time; /* @d24993 tjq */
    double adjusted_time;
    char start_stamp[50]; /* start time stamp for block */
    char end_stamp[50]; /* end time stamp for block */
    char tag[50]; /* block tag */
    char qry_description[100];
    struct stmt_info *next; /* @d24993 tjq */
};

/*****
/* Structure containing command line options */
/*****
struct comm_line_opt
{
    /* @d22275 tjq */
    char str_file_name[256]; /* output filename */
    char infile[256]; /* input filename */
    int intStreamNum; /* integer version of stream number */
    int a_commit; /* auto-commit flag */
    int short_time; /* time interval flag */
    int update;
    int outfile;
};

/*****
/* Structure used to hold precision for decimal numbers */
/*****
struct declen
{ /* kmw */
    unsigned char m; /* # of digits left of decimal */
    unsigned char n; /* # of digits right of decimal */
};

/*****
/* Structure containing control flags passed between functions */
/*****
struct ctrl_flags
{
    /* @d25594 tjq */
    int eo_infile;
    int time_stamp;
    int eo_block; /* @d30369 tjq */
    int select_status;
};

```

```

/*****/
/* Function Prototypes */
/*****/
int SleepSome( int amount );
int get_env_vars(void);
int Get_SQL_stmt(struct global_struct *g_struct);

void print_headings (struct sqlda *sqlda, int *col_lengths); /* @d22817
tjg */
void echo_sqlda(struct sqlda *sqlda, int *col_lengths);
void allocate_sqlda(struct sqlda *sqlda);

void get_start_time(Timer_struct *start_time);
double get_elapsed_time (Timer_struct *start_time);

long error_check(void); /* @d28763 tjg */
void dumpCa(struct sqlca*); /*kwm*/

void display_usage(void);
char *uppercase(char *string);
char *lowercase(char *string);
void comm_line_parse(int agrc, char *argv[], struct global_struct
*g_struct);
void sqlrxd2a(char *decptr, char *asciiptr, short prec, short scal);
void init_setup(int argc, char *argv[], struct global_struct *g_struct);
void runUF1( struct global_struct *g_struct, int updatePair );
void runUF2( struct global_struct *g_struct, int updatePair );

/* These need to be extern because they're in another SQC file. aph
981205 */
/*extern void runUF1_fn( int updatePair, int i );*/ /* aph
981205 */
/*extern void runUF2_fn( int updatePair, int i, int numChunks );*/ /* aph
981205 */
/* Added four new arguments because SQL host vars can't be global.
aph 981205 */
extern void runUF1_fn ( int updatePair, int i, char *dbname, char
*userid, char *passwd );
extern void runUF2_fn ( int updatePair, int thisConcurrentDelete, int
numChunks, char *dbname, char *userid, char *passwd );

int sem_op (int semid, int semnum, int value);

char *get_time_stamp(int form, Timer_struct *timer_pointer); /*
TIME_ACC jen */
void summary_table (struct global_struct *g_struct);
void free_sqlda (struct sqlda *sqlda, int select_status); /* @d30369
tjg */
void output_file(struct global_struct *g_struct);
int PreSQLprocess(struct global_struct *g_struct, Timer_struct
*start_time);
void SQLprocess(struct global_struct *g_struct);
int PostSQLprocess(struct global_struct *g_struct, Timer_struct
*start_time);
int cleanup(struct global_struct *g_struct);

/* Semaphore control functions */
void create_semaphores(struct global_struct *g_struct);
void throughput_wait(struct global_struct *g_struct);
void runpower_wait(struct global_struct *g_struct, int sem_num);
void release_semaphore(struct global_struct *g_struct, int sem_num);
#ifdef SQLWINT
HANDLE open_semaphore(struct global_struct *g_struct, int num);
#else
int open_semaphore(struct global_struct *g_struct);
#endif

EXEC SQL INCLUDE SQLCA;

```

```

/*****/
/* Declare the SQL host variables. */
/*****/
EXEC SQL BEGIN DECLARE SECTION;

char stmt_str1[4000] = "\0"; /* Assume max SQL statment
of 4000 char */
struct {
short len;
char data[32700];
} stmt_str; /* jen LONG */
char dbname[9] = "\0";
char userid[9] = "\0";
char passwd[9] = "\0";
char sourcefile[256]; /* used for semaphores and table
functions?*/
sqlint32 chunk = 0; /* jenCI counter for within the set of
chunks*/

EXEC SQL END DECLARE SECTION;

/*****/
/* Declare the global variables. */
/*****/
struct sqlda *sqlda; /* SQL Descriptor area */

/* Global environment variables (sks May 25 98)*/
char env_tpcd_dbname[100];
char env_user[100];
char env_tpcd_audit_dir[150];
char env_tpcd_path_delim[2];
char env_tpcd_tmp_dir[150];
char env_tpcd_run_on_multiple_nodes[10];
char env_tpcd_copy_dir[150];
char env_tpcd_update_import[10];

/* Other globals */
FILE *instream, *outstream; /* File pointers */
int verbose = 0; /* Verbose option flag */
int semcontrol = 1; /* allows/disallows smaphores usage
*/
int updatePairStart; /* update pair to start at */
int currentUpdatePair; /* update pair running */
int updatePairStop; /* update pair to stop before */
char newtime[50]="\0"; /* Des - moved from
get_time_stamp */
char outstreamfilename[256]; /* store filename of outstream
wlc 081397 */
int inlistmax = 400; /* define # of keys to delete at a time
wlc 081897 */
int sqlda_allocated = 0; /* fixing free() problem in NT
wlc 090597 */
int ilmportStagingTbl=0; /* IMPORT use import or load
(default) */
char temp_time_stamp[50]; /* holds end timestamp to be
copied into start_time_stamp of next query bbeaton */
Timer_struct temp_time_struct; /* holds end time value to be
copied into start_time of next query bbeaton */

/* constants for the semaphores used; 1 for throughput and 2 for power
*/
#define INSERT_POWER_SEM 1
#define QUERY_POWER_SEM 2
#define THROUGHPUT_SEM 1

/*****/
/* Start main program processing. */
/*****/
int main(int argc, char *argv[])

```

```

{
struct comm_line_opt c_l_opt = { "\0", "\0", 0, 1, 0, 0, 0 };
/* command line options */
Timer_struct      start_time;      /* start point for elapsed time */

struct stmt_info  s_info = { -1, -1, 0, 1, -1, -1, "\0", "\0", "\0", "\0",
NULL };
/* first stmt_info structure */

struct ctrl_flags c_flags = { 0, 1, 0, TPCDBATCH_SELECT };
/* structure holding ctrl flags
passed between functions */

/* TIME_ACC jen start */
#if defined (SQLUNIX) || defined (SQLAIX)
struct global_struct g_struct =
{ NULL, NULL, NULL, NULL, {0,0}, {0,0}, "\0", 0.1, "\0", FALSE, 0,
NULL, "\0", "\0", "\0", NULL };
#elif defined (SQLOS2) || defined (SQLWINT) || defined (SQLWIN) ||
defined (SQLDOS))
struct global_struct g_struct =
{ NULL, NULL, NULL, NULL, {0,0,0,0}, {0,0,0,0}, "\0", 0.1, "\0",
FALSE, 0,
NULL, "\0", "\0", "\0", NULL };
#else
#error Unknown operating system
#endif
/* TIME_ACC jen end */

/* Get environment variables */
if (get_env_vars() != 0)
return -1;

/* perform setup and initialization and get process id of agent */
outstream = stdout;
g_struct.c_flags = &c_flags;

g_struct.s_info_ptr = &s_info;
g_struct.c_l_opt = &c_l_opt;

init_setup(argc,argv,&g_struct);          /* @d22275 tlg */

if ((g_struct.c_l_opt->update == 1) && (semcontrol == 1))
/* runpower: wait for insert function to complete */
/* waiting on the INSERT_POWER_SEM semaphore */
runpower_wait(&g_struct, INSERT_POWER_SEM);

strcpy(temp_time_stamp, "0");
/*****
*
* This is the transition from the "driver" to the "SUT"
*
*****/

/*****
/* Read in each statement, prepare, execute, and send output to file.
*/
/*****

while (!c_flags.eo_infile) { /* Check to see if there's no more input */

c_flags.eo_block = 0;

if (c_l_opt.outfile)

```

```

output_file(&g_struct); /* determine appropriate name for output
files */
if ((g_struct.c_l_opt->update != 3) && (g_struct.c_l_opt->update !=
4))
{
if (!strcmp(temp_time_stamp, "0")) /* if first query, get timestamp */
{
get_start_time(&start_time);
strcpy(g_struct.s_info_ptr->start_stamp,
get_time_stamp(T_STAMP_FORM_3,&start_time)); /*
TIME_ACC jen*/
}
else /* else get the end timestamp of previous query */
{
strcpy(g_struct.s_info_ptr->start_stamp, temp_time_stamp);
start_time = temp_time_struct;
}
/* write the start timestamp to the file...if this is not a qualification */
/* run, then write the seed used as well */

fprintf( outstream,"Start timestamp %*. *s \n",
T_STAMP_3LEN,T_STAMP_3LEN,          /* TIME_ACC
jen*/
g_struct.s_info_ptr->start_stamp);
if (c_l_opt.intStreamNum >= 0)
{
if (g_struct.lSeed == -1)
{
fprintf( outstream,"Using default qgen seed file");
}
else
fprintf( outstream,"Seed used = %ld",g_struct.lSeed);

fprintf( outstream,"\n");
}
}
do { /* Loop through these statements as long as we haven't
reached
the end of the input file or the end of a block of statements
*/

/**/ Read in the next statement **/
c_flags.select_status=Get_SQL_stmt(&g_struct);

if (PreSQLprocess(&g_struct, &start_time) == FALSE)
/* if after reading the next statement we see that we should
exit this loop (i.e. eof, update functions, etc...), get out
*/
break;

/*****
*
* The SQLprocess function implements the implementation
specific layer.
* It can handle arbitrary SQL statements.
*
*****/

/* If we've got up to here then processing
a regular SQL statement */
SQLprocess(&g_struct);

} while ((!c_flags.eo_block) && (!c_flags.eo_infile)); /* @d30369
tlg */

if (PostSQLprocess(&g_struct,&start_time) == FALSE)
/* if we've reached the end of the input file, then get out

```

```

of this loop (i.e. no more statements). Otherwise get
elapsed times and display info about rows */
break;

} /* end of for loop for multiple SQL statements */

g_struct.s_info_ptr = &s_info; /* set the global pointer to start of
linked list */

cleanup(&g_struct); /* finish some semaphore stuff, cleanup files,
and print out summary table */

/*****
*
* In cleanup we make the transition back from the "SUT" to the
"driver" *
*
*****/

return(0);

} /* end of main */

/*****/
/* Generic form of Sleep */
int SleepSome( int amount)
{
#ifdef SQLWINT
sleep (amount);
#else
Sleep (amount*1000); /* 10x for NT DJD Changed "sleep" to
"Sleep" */
#endif
return 0;
}

/*****/

/* Get environment variables. (sks May 25 98) */
/*****/
int get_env_vars(void) {
if (strcpy(env_tpcd_dbname, getenv("TPCD_DBNAME")) == NULL) {
fprintf(stderr, "\n The environment variable $TPCD_DBNAME is not
setup correctly.\n");
return -1;
}
if (strcpy(env_user, getenv("USER")) == NULL) {
fprintf(stderr, "\n The environment variable $USER is not setup
correctly.\n");
return -1;
}
if (strcpy(env_tpcd_audit_dir, getenv("TPCD_AUDIT_DIR")) ==
NULL) {
fprintf(stderr, "\n The environment variable $TPCD_AUDIT_DIR is
not setup correctly.\n");
return -1;
}
if (strcpy(env_tpcd_tmp_dir, getenv("TPCD_TMP_DIR")) == NULL) {
fprintf(stderr, "\n The environment variable $TPCD_TMP_DIR is not
setup correctly.\n");
return -1;
}
}
#if 0
if (strcpy(env_tpcd_path_delim, getenv("TPCD_PATH_DELIM")) ==
NULL ||

```

```

(strcmp(env_tpcd_path_delim, "/") &&
strcmp(env_tpcd_path_delim, "\\")){
fprintf(stderr, "\n The environment variable $TPCD_PATH_DELIM is
not setup correctly , env_tpcd_path_delim%s'.\n",
env_tpcd_path_delim);

return -1;
}
#endif
strcpy( env_tpcd_path_delim , "/" ); /*kmw*/
if (strcpy(env_tpcd_run_on_multiple_nodes,
getenv("TPCD_RUN_ON_MULTIPLE_NODES")) == NULL) {
fprintf(stderr, "\n The environment variable
$TPCD_RUN_ON_MULTIPLE_NODES");
fprintf(stderr, "\n is not setup correctly.\n");
return -1;
}
if (strcpy(env_tpcd_copy_dir, getenv("TPCD_COPY_DIR")) ==
NULL) {
fprintf(stderr, "\n The environment variable $TPCD_COPY_DIR is
not setup correctly.\n");
return -1;
}
/* If TPCD_UPDATE_IMPORT is not set then, the default is set to
false, */
/* which is done in init_setup subroutine */
strcpy(env_tpcd_update_import,
getenv("TPCD_UPDATE_IMPORT"));

return 0;
}

/*****/
/* Get the SQL statement and any control statements from input. */
/*****/
int Get_SQL_stmt(struct global_struct *g_struct)

{
char input_ln[256] = "\0"; /* buffer for 1 line of text */
char temp_str[4000] = "\0"; /* temp string for SQL stmt */
char control_str[256] = "\0"; /* control string */

char *test_semi; /* ptr to test for semicolon */
char *control_opt; /* ptr used in control_str parsing */
char *select_status; /* ptr to first word in query */
char *temp_ptr; /* general purpose temp ptr */

int good_sql = 0; /* good-sql stmt flag @d23684 tjg */
int stmt_num_flag = 1; /* first line of SQL stmt flag */
int eostmt = 0; /* flag to signal end of statement */

stmt_str.data[0]=\0; /* Initialize statement buffer */

if (verbose)
fprintf (stderr, "\n-----\n");
fprintf (outstream, "\n-----\n");

do {
/** Read in lines from input one at a time */
fscanf(instream, "%n%[\n]\n", input_ln);

if (strstr(input_ln, "--") == input_ln) { /* Skip all -- comments */

if (strstr(input_ln, "--SET") == input_ln) {
/* Store control string but
keep going to find SQL stmt */
strcpy(control_str, input_ln);
if (verbose)
fprintf(stderr, "%s\n", uppercase(control_str));

```

```

fprintf(outstream,"%s\n", uppercase(control_str));

/* Start parsing control str. and update appropriate vars. */
control_opt = strtok(control_str, "");
while (control_opt != NULL) {
    if (strcmp(control_opt, "--SET") { /* Skip the #SET token */
        if (!strcmp(control_opt, "ROWS_FETCH"))
            g_struct->s_info_ptr->max_rows_fetch =
atoi(strtok(NULL, ""));

        if (!strcmp(control_opt, "ROWS_OUT"))
            g_struct->s_info_ptr->max_rows_out = atoi(strtok(NULL, ""));
    }

    control_opt = strtok(NULL, "");
}

/* if the block option has been set, then check if we've
reached the end of a block of statements */
if (g_struct->s_info_ptr->query_block) /* @d30369 tjj
*/
    if (strstr(input_ln, "--EOBLK") == input_ln) {
        g_struct->c_flags->eo_block = 1;
        return TPCDBATCH_EOBLOCK;
    }
    if (strstr(input_ln, "-- Query") == input_ln)
        strcpy(g_struct->s_info_ptr->qry_description, input_ln);

    if (strstr(input_ln, "--#TAG") == input_ln)
        strcpy(g_struct->s_info_ptr->tag, (input_ln+sizeof("--#TAG")));

    /* if we're using update functions, return that info
appropriately */
    if (g_struct->c_l_opt->update != 0) {
        if (strstr(input_ln, "--#INSERT") == input_ln)
            return TPCDBATCH_INSERT;

        if (strstr(input_ln, "--#DELETE") == input_ln)
            return TPCDBATCH_DELETE;
    }

    if (strstr(input_ln, "--#COMMENT") == input_ln) { /* @d25594
tjj */
        temp_ptr = (input_ln + 11); /* User-specified comments go to
the outfile */

        if (verbose)
            fprintf(stderr, "%s\n", temp_ptr);
        fprintf(outstream, "%s\n", temp_ptr);
    }

    eostmt=0;
}

/* Need this hack here to check if there's any more empty lines left
in the input file. Continue only if there are aren't any */
else if (strcmp(input_ln, "\0")) /* HACK */ { /* A regular SQL
statement */
    if (stmt_num_flag) { /* print this out only if it's the first line
of the SQL statement. We only want this
line to appear once per statement */
        if (verbose)
            fprintf(stderr, "\n%s\n", g_struct->s_info_ptr->qry_description);
        fprintf(outstream, "\n%s\n", g_struct->s_info_ptr-
>qry_description);

        if (verbose)
            fprintf(stderr, "\nTag: %-5.5s Stream: %d Sequence number:
%d\n",

```

```

        g_struct->s_info_ptr->tag, g_struct->c_l_opt-
>intStreamNum,
        g_struct->s_info_ptr->stmt_num); /*jen0925*/
        fprintf(outstream, "\nTag: %-5.5s Stream: %d Sequence
number: %d\n",
            g_struct->s_info_ptr->tag, g_struct->c_l_opt-
>intStreamNum,
            g_struct->s_info_ptr->stmt_num); /*jen0925*/

        /* Turn off this flag once the number has been printed */
        stmt_num_flag = 0;

    } /* Print out this heading the first time you encounter a
non-comment statement */

    /* Test to see if we've reached the end of a statement */
    good_sql = TRUE; /* @d23684 tjj */
    test_semi = strstr(input_ln, ";");
    if (test_semi == NULL) { /* if there's no semi-colon keep on
going */
        strcat(stmt_str.data, input_ln); /* jen LONG */
        strcat(stmt_str.data, ""); /* jen LONG */
        stmt_str.len = strlen(stmt_str.data); /* jen LONG */
        eostmt = 0;
    }

    else { /* else replace the ; with a \0 and continue */
        *test_semi = '\0';
        strcat(stmt_str.data, input_ln); /* jen LONG */
        stmt_str.len = strlen(stmt_str.data); /* jen LONG */
        eostmt = 1;
    }

    fprintf(outstream, "\n%s", input_ln);
    if (verbose)
        fprintf(stderr, "\n%s", input_ln);
}

/* Test to see if we've reached the EOF. Get out if that's the case
*/
if (feof(instream)) {
    eostmt = TRUE;
    g_struct->c_flags->eo_infile = TRUE; /* @d22275 tjj
*/
}

} while (!eostmt);

fprintf(outstream, "\n");
if (verbose)
    fprintf(stderr, "\n");

/* erase the old control string */
strcpy(control_str, "\0");

/* Determine whether statement is a SELECT or other SQL */
if (good_sql) {
    strcpy(temp_str, stmt_str.data); /* jen LONG */
    uppercase(temp_str); /* Make sure that select is made to SELECT
*/
    select_status = strtok(temp_str, "");
    if ( (stmt_str.data[0] == '(') || (!strcmp(select_status, "SELECT")) ||
(!strcmp(select_status, "VALUES")) ||
(!strcmp(select_status, "WITH")) )
        return TPCDBATCH_SELECT;
    else
        return TPCDBATCH_NONSELECT;
}
}

```

```

/** If you go through a file with just comments or control statements
with no SQL, there's nothing to process...Exit TPCDBATCH **/

else /* @d23684 tjj */
return TPCDBATCH_NONSQL;

} /* Get_SQL_stmt */

/*****
/* allocate_sqlda -- This routine allocates space for the SQLDA. */
*****/

void allocate_sqlda(struct sqlda *sqlda)
{
int loopvar; /* Loop counter */

for (loopvar=0; loopvar<sqlda->sqlc; loopvar++)
{
switch (sqlda->sqlvar[loopvar].sqltype)
{
case SQL_TYP_INTEGER: /* INTEGER */
case SQL_TYP_NINTEGER:
if ((sqlda->sqlvar[loopvar].sqldata=
(TPCDBATCH_CHAR *)malloc(sizeof(sqlint32))) ==
NULL)
mem_error("allocating INTEGER");
break;
case SQL_TYP_BIGINT: /* BIGINT */
/*kmwBIGINT*/
case SQL_TYP_NBIGINT:
/*#ifdef SQLWINT */
/* if ((sqlda->sqlvar[loopvar].sqldata= */
/* (TPCDBATCH_CHAR *)malloc(sizeof(__int64))) == */
/* NULL)*/
/* #else */
if ((sqlda->sqlvar[loopvar].sqldata=
(TPCDBATCH_CHAR *)malloc(sizeof(sqlint64))) ==
NULL)
/* #endif*/
mem_error("allocating BIGINT");
break;
case SQL_TYP_CHAR: /* CHAR */
case SQL_TYP_NCHAR:
if ((sqlda->sqlvar[loopvar].sqldata=
(TPCDBATCH_CHAR *)calloc(256,sizeof(char))) ==
NULL)
mem_error("allocating CHAR/VARCHAR");
break;
case SQL_TYP_VARCHAR: /* VARCHAR */
case SQL_TYP_NVARCHAR:
if ((sqlda->sqlvar[loopvar].sqldata=
(TPCDBATCH_CHAR *)calloc(4002,sizeof(char))) ==
NULL)
mem_error("allocating CHAR/VARCHAR");
break;
case SQL_TYP_LONG: /* LONG VARCHAR */
case SQL_TYP_NLONG:
if ((sqlda->sqlvar[loopvar].sqldata=
(TPCDBATCH_CHAR *)calloc(32702,sizeof(char))) ==
NULL)
mem_error("allocating VARCHAR/LONG VARCHAR");
break;
case SQL_TYP_FLOAT: /* FLOAT */
case SQL_TYP_NFLOAT:
if ((sqlda->sqlvar[loopvar].sqldata=
(TPCDBATCH_CHAR *)malloc(sizeof(double))) == NULL)
mem_error("allocating FLOAT");
break;
}
}
}

```

```

case SQL_TYP_SMALL: /* SMALLINT */
case SQL_TYP_NSMAIL:
if ((sqlda->sqlvar[loopvar].sqldata=
(TPCDBATCH_CHAR *)malloc(sizeof(short))) == NULL)
mem_error("allocating SMALLINT");
break;
case SQL_TYP_DECIMAL: /* DECIMAL */
case SQL_TYP_NDECIMAL:
if ((sqlda->sqlvar[loopvar].sqldata=
(TPCDBATCH_CHAR *)malloc(20)) == NULL)
mem_error("allocating DECIMAL");
break;
case SQL_TYP_CSTR: /* VARCHAR (null
terminated) */
case SQL_TYP_NCSTR:
if ((sqlda->sqlvar[loopvar].sqldata=
(TPCDBATCH_CHAR *)calloc(4001,sizeof(char))) ==
NULL)
mem_error("allocating CHAR/VARCHAR");
break;
case SQL_TYP_DATE: /* DATE */
case SQL_TYP_NDATE:
if ((sqlda->sqlvar[loopvar].sqldata=
(TPCDBATCH_CHAR *)calloc(13,sizeof(char))) == NULL)
mem_error("allocating DATE");
break;
case SQL_TYP_TIME: /* TIME */
case SQL_TYP_NTIME:
if ((sqlda->sqlvar[loopvar].sqldata=
(TPCDBATCH_CHAR *)calloc(11,sizeof(char))) == NULL)
mem_error("allocating TIME");
break;
case SQL_TYP_STAMP: /* TIMESTAMP */
case SQL_TYP_NSTAMP:
if ((sqlda->sqlvar[loopvar].sqldata=
(TPCDBATCH_CHAR *)calloc(29,sizeof(char))) == NULL)
mem_error("allocating TIMESTAMP");
break;
}
if ((sqlda->sqlvar[loopvar].sqlind=
(short *)calloc(1,sizeof(short))) == NULL)
mem_error("allocating indicator");
}
}
sqlda_allocated = 1; /* fix free() problem on NT
wlc 090597 */
return; /* allocate_sqlda */
}

/*****
/* echo_sqlda -- This routine displays the contents of an SQLDA.
*/
*****/

void echo_sqlda(struct sqlda *sqlda, int *col_lengths)
{
int col; /* Column counter */

int col_type; /* Type of column */

char temp_string[100] = "\0"; /* Temporary string */
char decimal_string[100] = "\0"; /* String holding decimals */
char *temp_ptr;

TPCDBATCH_CHAR m,n; /* precision and accuracy
for decimal conversion */

```

```

for (col=0; col<sqlda->sqlc; col++) /* Loop through column count */
{
    col_type=sqlda->sqlvar[col].sqltype;          /* @d22817 tlg */

    if (*(sqlda->sqlvar[col].sqlind))             /* @d30369 tlg */
        fprintf(outstream, "%* n/a ",(col_lengths[col]-3));
    else
        switch (col_type)
        {
            case SQL_TYP_INTEGER:
            case SQL_TYP_NINTEGER:

                fprintf(outstream, "%*ld ",col_lengths[col],
                    *(sqlint32 *) (sqlda->sqlvar[col].sqldata));
                break;

            case SQL_TYP_BIGINT: /*kmwBIGINT*/
            case SQL_TYP_NBIGINT:
                /*#ifdef SQLWINT*/
                fprintf(outstream, "%*l64d ",col_lengths[col],/*
                /*      *(__int64 *) (sqlda->sqlvar[col].sqldata);*/
                /*#else*/
                fprintf(outstream, "%*lld ",col_lengths[col],
                    *(sqlint64 *) (sqlda->sqlvar[col].sqldata));
                /*#endif*/
                break;

            case SQL_TYP_CHAR:
            case SQL_TYP_NCHAR:

                fprintf(outstream, "%*s ",col_lengths[col],sqlda-
>sqlvar[col].sqldata);
                break;
            case SQL_TYP_VARCHAR:
            case SQL_TYP_NVARCHAR:
            case SQL_TYP_LONG:
            case SQL_TYP_NLONG:                    /* @d30369 tlg */
                ((struct sqlchar *)sqlda->sqlvar[col].sqldata)->
                data[((struct sqlchar *)sqlda->sqlvar[col].sqldata)->length] =
                "\0";
                fprintf(outstream, "%*s ",
                    col_lengths[col],
                    ((struct sqlchar *)sqlda->sqlvar[col].sqldata)->data);
                break;
            case SQL_TYP_FLOAT:
            case SQL_TYP_NFLOAT:
            { /* kmw */
                if ( fabs(*(double *) (sqlda->sqlvar[col].sqldata))
                    < TPCDBATCH_PRINT_FLOAT_MAX )
                    fprintf(outstream, "%*#.3f ",col_lengths[col],
                        *(double *) (sqlda->sqlvar[col].sqldata));
                else
                    fprintf(outstream, "%*e ",col_lengths[col],
                        *(double *) (sqlda->sqlvar[col].sqldata));
                break;
            }

            case SQL_TYP_SMALL:
            case SQL_TYP_NSMAIL:

                fprintf(outstream, "%*hd ",col_lengths[col],
                    *(short *) (sqlda->sqlvar[col].sqldata));
                break;
            case SQL_TYP_DECIMAL:
            case SQL_TYP_NDECIMAL:

                m=*(struct declen *)&sqlda->sqlvar[col].sqlen).m;
                n=*(struct declen *)&sqlda->sqlvar[col].sqlen).n;
                if (sqlrxd2a((char *)sqlda->sqlvar[col].sqldata,temp_string,m,n)
!= 0)

```

```

        {
            fprintf(stderr, "\nThe decimal value could not be
converted.\n");
            exit (-1);
        }
        else {

            temp_ptr = temp_string;

            if (*temp_ptr == '-')
                strcpy(decimal_string, "-");

            else
                strcpy(decimal_string, "");

            for (temp_ptr = temp_string + 1; *temp_ptr == '0'; temp_ptr++)
                ;

            strcat(decimal_string,temp_ptr);
            fprintf(outstream, "%*s ",col_lengths[col],decimal_string);
        }

        break;

        case SQL_TYP_CSTR:
        case SQL_TYP_NCSTR:
        case SQL_TYP_DATE:
        case SQL_TYP_NDATE:
        case SQL_TYP_TIME:
        case SQL_TYP_NTIME:
        case SQL_TYP_STAMP:
        case SQL_TYP_NSTAMP:
            sqlda->sqlvar[col].sqldata[sqlda->sqlvar[col].sqlen+1]='\0';
            strcpy(temp_string,(char *)sqlda->sqlvar[col].sqldata);
            fprintf(outstream, "%*s ",(col_lengths[col]),temp_string);
            break;

        default:
            fprintf(stderr, "--Unknown column type (%d).
Aborting.\n",col_type);
            break;
        }
    }

    fprintf(outstream, "\n");

    return;
}

/******
/* Calculate the elapsed time. */
/******

void get_start_time(Timer_struct *start_time)
{
    int rc = 0;

    #if defined (SQLOS2) || defined (SQLWINT) || defined (SQLWIN) ||
defined (SQLDOS)
        /*@d33143aha*/
        ftime (start_time);
    #elif defined (SQLSNI)
        rc = gettimeofday(start_time);
    #elif defined (SQLPTX)
        gettimeofday_mapped(start_time);
        rc = 0; /* gettimeofday_mapped returns void */
    #elif defined (SQLUNIX) || defined (SQLAIX) /*TIMER
        jen*/
        rc = gettimeofday(start_time,NULL);

```



```

#else
#error Unknown operating system
#endif

    if (rc != 0) {
        fprintf(stderr,"Timer call failed, aborting test\nExiting
tpcdbatch..\n");
        exit(-1);
    }
}

/*****
/* Calculate and return the elapsed time given a starting time. */
/*****
double get_elapsed_time ( Timer_struct *start_time)
{
    int          status = 0;
    Timer_struct end_time;
    double       result = -1.0;
#ifdef SQLWINT
    long int     result_sec;
    long int     result_usec;
#endif

#ifdef(SQLSNI)
    status = gettimeofday(&end_time);
#elif defined(SQLPTX)
    gettimeofday_mapped(&end_time);
    status = 0; /* gettimeofday_mapped returns void */
#elif defined (SQLUNIX) || defined (SQLAIX)
    status = gettimeofday(&end_time,NULL); /*TIMER jen*/
#elif defined (SQLOS2) || defined (SQLWINT) || defined (SQLWIN) ||
defined(SQLDOS)
    ftime(&end_time);
#else
    /** If another operating system **/
#error Unknown operating system
#endif

    if (status != 0)
        fprintf(stderr,"Bad return from gettimeofday, don't trust timer
results...\n");

    else
    {
#ifdef (SQLUNIX) || defined (SQLAIX)
        result_sec = end_time.tv_sec - start_time->tv_sec;
        result = (double) result_sec;
        /* TIMER used micro seconds with timeval (not nanoseconds) */
        if ((start_time->tv_usec > 0) && \
            (start_time->tv_usec < 1000000) && \
            (end_time.tv_usec > 0) && \
            (end_time.tv_usec < 1000000))
        {
            result_usec = end_time.tv_usec - start_time->tv_usec;
            result = (double) result_sec + ((double) result_usec/1000000);
        }
#elif (defined (SQLOS2) || defined (SQLWINT) || defined (SQLWIN) ||
defined(SQLDOS))
        result = (double) (end_time.time - start_time->time);
        result = result * 1000 + (end_time.millitm - start_time->millitm);
        result = result/1000;
#else
#error Unknown operating system
#endif
    }
}

```

```

/*
 * translate the time to that rounded to the CLOSEST 0.1 seconds as
 * required by the TPC-D spec. ROUNDING
 */
/* result = (double)((long)((result + 0.099999) * 10))/10.0;*/
result = (double)((long)((result + 0.05) * 10))/10.0;
return (result);
}

void dumpCa(struct sqlca *ca)
{
    int i;
    fprintf(outstream,"***** DUMP OF SQLCA
*****\n");
    fprintf(outstream,"SQLCAID : %.8s\n", ca->sqlcaid);
    fprintf(outstream,"SQLCABC : %d\n", ca->sqlcabc);
    fprintf(outstream,"SQLCODE : %d\n", ca->sqlcode);
    fprintf(outstream,"SQLERRML : %d\n", ca->sqlerrml);
    fprintf(outstream,"SQLERRMC : %s\n", ca->sqlerrmc);
    fprintf(outstream,"SQLERRP : %.8s\n", ca->sqlerrp);

    for (i = 0; i < 6; i++)
    {
        fprintf(outstream,"SQLERRD[%d]: %d\n", i, ca->sqlerrd[i] );
    }
    fprintf(outstream,"SQLWARN : %.11s\n", ca->sqlwarn);
    fprintf(outstream,"SQLSTATE : %.5s\n", ca->sqlstate);
    fprintf(outstream,"***** END OF SQLCA DUMP
*****\n");
    return;
}

/*****
/* error_check */
/* This function prints the contents of the sqlca error information */
/* structure. */
/*****
long error_check(void)
{
    char buffer[512]="\0";
    unsigned short i;
    struct sqlca temp_sqlca; /* temporary sqlca */ /* @d30369 tjg */

    temp_sqlca.sqlcode = 0; /* initialize the temporary sqlca to
avoid any memory problems */

    if (sqlca.sqlcode != 0) {
        sqlaintp(buffer, sizeof(buffer), 80, &sqlca);
        fprintf(stderr, "\n%0.200s\n", buffer);
        fprintf(outstream, "\n%0.200s\n", buffer);

        /* Decode the SQLCA in more detail KBS 98/09/28 */
        if ((sqlca.sqlerrml) /* there's one or more tokens */
            && (sqlca.sqlerrml < sizeof(sqlca.sqlerrmc)) /* and field not full */
            )
        {
            char *tokptr;
            int tokl;
            *(sqlca.sqlerrmc + sqlca.sqlerrml) = '\0'; /* prevent strtok from
scanning beyond end */
            fprintf(stderr, "\n SQLCA: tokens:\n");
            fprintf(outstream, "\n SQLCA: tokens:\n");
            tokptr=strtok(sqlca.sqlerrmc, "\xff");
            while ( tokptr &&
                ( tokl = (sizeof(sqlca.sqlerrmc) - (tokptr-sqlca.sqlerrmc))) >
0)

```

```

    )
    {
        fprintf(stderr, "%.*s\n", tokl, tokptr);
        fprintf(outstream, "%.*s\n", tokl, tokptr);
        tokptr=strtok(NULL, "\\xff");
    }
}
fprintf(stderr, "\n SQLCA: errp= %.8s, errd 1-6= %d %d %d %d
%d %d\n",
        sqlca.sqlerrp, sqlca.sqlerrd[0], sqlca.sqlerrd[1],
sqlca.sqlerrd[2],
        sqlca.sqlerrd[3], sqlca.sqlerrd[4], sqlca.sqlerrd[5]);
fprintf(outstream, "\n SQLCA: errp= %.8s, errd 1-6= %d %d %d
%d %d %d\n",
        sqlca.sqlerrp, sqlca.sqlerrd[0], sqlca.sqlerrd[1],
sqlca.sqlerrd[2],
        sqlca.sqlerrd[3], sqlca.sqlerrd[4], sqlca.sqlerrd[5]);

temp_sqlca = sqlca; /* Make a copy of sqlca in case it gets
changed
        in the next statement below */ /* @d30369 tjq */

/** Determine if the error is critical or a connection can be made **/
EXEC SQL CONNECT ; /* @d28763 tjq */

if (sqlca.sqlcode == SQLE_RC_NOSUDB ) { /* no connection
exists */

/*Print out header for DUMP*/
fprintf(outstream, "*****\n");
fprintf(outstream, "** CONTENTS OF SQLCA *\n");
fprintf(outstream, "*****\n\n");

/*Print out contents of SQLCA variables*/
fprintf(outstream, "SQLCABC = %ld\n", temp_sqlca.sqlcabc);
fprintf(outstream, "SQLCODE = %ld\n", temp_sqlca.sqlcode);
fprintf(outstream, "SQLERRMC = %0.70s\n",
temp_sqlca.sqlerrmc);
fprintf(outstream, "SQLERRP = %0.8s\n", temp_sqlca.sqlerrp);

for (i = 0; i < 6; i++)
{
    fprintf(outstream, "sqlerrd[%d] = %lu \n", i,
temp_sqlca.sqlerrd[i]);
}

fprintf(outstream, "SQLWARN = %0.11s\n",
temp_sqlca.sqlwarn);
fprintf(outstream, "SQLSTATE = %0.5s\n", temp_sqlca.sqlstate);

fprintf(stderr, "\nCritical SQLCODE. Exiting TPCDBATCH\n");
exit(-1);
}
}
return (temp_sqlca.sqlcode);
} /* error_check */

/*****
/* Displays a help screen */
/*****
void display_usage()
{
    printf("\ntpcdbatch -- version %s",TPCDBATCH_VERSION);
    printf("\n\nSyntax is:\n");
    printf("tpcdbatch [-d dbname] [-f file_name] [-l file_name] [-r on/off]");

```

```

printf("\n [-v on/off] [-b on/off] [-u p/t1/t2]");
printf("\n [-s scale_factor] [-n stream_num] [-m inlistmax] [-h]\n");
printf("\n where: -d Database name");
printf("\n Default - dbname set in $DB2DBDFT");
printf("\n -f Input file containing SQL statements");
printf("\n Default - stdin ");
printf("\n -l Input file containing list of statement numbers");
printf("\n -r Create set of output files containing query results");
printf("\n Default - off");
printf("\n -v Verbose. Sends information to stderr during");
printf("\n query processing");
printf("\n Default - off");
printf("\n -b Process groups of statements as blocks ");
printf("\n instead of individually.");
printf("\n Default - off");
printf("\n -u Update streams: p - for power test");
printf("\n t - for throughput test without");
printf("\n UFs (run this instead of t2)");
printf("\n t1 - for throughput test step 1");
printf("\n only running queries");
printf("\n t2 - for throughput test step 2");
printf("\n running update functions");
printf("\n -s Scale factor");
printf("\n Default - 0.1");
printf("\n -n Stream number");
printf("\n Default - 0");
printf("\n Qualification - -1");
printf("\n Power - 0");
printf("\n Throughput - >= 1 (actual number depends on
the current query stream");
printf("\n -m Maximum number of keys to delete at a time");
printf("\n Default - 400");
printf("\n -h Display this help screen");
printf("\n -p turns smeaphores on or off");
printf("\n Default - off");

printf("\n\nControl statements specifying output and performance
details");
printf("\ncan be included before SQL statements; they will apply for");
printf("\nthat and subsequent statements until updated.");

printf("\n\nSyntax: --#SET <control option> <value>");
printf("\n\n option value default");
printf("\nROWS_FETCH -1 to n -1 (all rows fetched from answer
set)");
printf("\nROWS_OUT -1 to n -1 (all fetched rows sent to
output)");
printf("\n--#TAG tag (user specified tag name for
sequence#)");
printf("\n--#COMMENT comment (user specified comments for
output)");
printf("\nNote: All statements executed with ISOLATION LEVEL
RR");
printf("\n and must be terminated with semi-colons.\n");
exit (1);
}

/*****
/* Converts a string to upper case characters */
/*****
char *uppercase( char *string )
{
    char *c; /* temp char used to convert word to upper case */

for ( c = string; *c != '\0'; c++)
    *c = (char) toupper( (int) *c );

return (string);
}

```

```

/*****
/* Converts a string to lower case characters */
/*****
char *lowercase( char *string )
{
    char *c; /* temp char used to convert word to lower case */

    for ( c = string; *c != '\0'; c++)
        *c = (char) tolower( (int) *c );

    return (string);
}

/*****
/* Parses and processes command line options. */
/*****

void comm_line_parse(int argc, char *argv[], struct global_struct
*g_struct)
{
    char authent_info[40] = "\0";
    char *testptr;
    int loopvar = 0;

    int comm_opt = 0;
#ifdef PARALLEL_UPDATES
    int running_updates=0;
    int updatePair=-1;
    int updateStream=-1;
    int function;
    int copyOnOrOff;
    int deleteChunk=0; /*DELjen */
#endif

    while ((loopvar < argc) && (argc != 1)) {

        if (*argv[loopvar] == '-') {

            switch(*(argv[loopvar]+1)) {

                case 'f': /* @d26350 tjj */
                case 'F':
                    strcpy(g_struct->c_l_opt->infile,argv[++loopvar]);
                    break;

                case 'l': /* @d26350 tjj */
                case 'L': strcpy(g_struct->c_l_opt-
>str_file_name,argv[++loopvar]);
                    break;

                case 'r': /* @d26350 tjj */
                case 'R':
                    if (!strcmp(uppercase(argv[++loopvar]),"ON"))
                        g_struct->c_l_opt->outfile=1;
                    else
                        g_struct->c_l_opt->outfile=0;
                    break;

                case 'd': /* @d26350 tjj */
                case 'D':
                    strcpy(dbname,argv[++loopvar]);
                    break;

                case 'v': /* @d26350 tjj */
                case 'V':
                    if (!strcmp(uppercase(argv[++loopvar]),"ON"))
                        verbose=1;
                    else

```

```

        verbose=0;
        break;

        case 'u': /* @d26350 tjj */
        case 'U':
            g_struct->c_l_opt->update=-1; /* init to invalid number */
            if (!strcmp(uppercase(argv[++loopvar]),"P1"))
                g_struct->c_l_opt->update=1; /* power query stream */
            if (!strcmp(uppercase(argv[loopvar]),"P2"))
                g_struct->c_l_opt->update=3; /* power update with
updates*/
            if (!strcmp(uppercase(argv[loopvar]),"P"))
                g_struct->c_l_opt->update=4; /* power update without
updates*/
            if (!strcmp(uppercase(argv[loopvar]),"T1"))
                g_struct->c_l_opt->update=0; /*throughput query stream */
            if (!strcmp(uppercase(argv[loopvar]),"T2"))
                g_struct->c_l_opt->update=2; /* throughput update with
updates */
            if (!strcmp(uppercase(argv[loopvar]),"T"))
                g_struct->c_l_opt->update=5; /* throughput update without
updates */

            break;

        case 'b': /* @d26350 tjj */
        case 'B':
            if (!strcmp(uppercase(argv[++loopvar]),"ON"))
                g_struct->s_info_ptr->query_block=1;
            else
                g_struct->s_info_ptr->query_block=0;
            break;

        case 'n': /* @d26350 tjj */
        case 'N':
            g_struct->c_l_opt->intStreamNum = atoi(argv[++loopvar]);
            break;

        case 's': /* @d26350 tjj */
        case 'S': g_struct->scale_factor=atof(argv[++loopvar]); break;

        case 'h':
        case 'H': /* @d26350 tjj */
            display_usage();
            break;

        case 'm':
        case 'M':
            inlistmax = atoi(argv[++loopvar]); /* wlc 081897 */
            break;

        case 'p':
        case 'P':
            if (!strcmp(uppercase(argv[++loopvar]),"ON")) /* bbe 072599 */
                semcontrol = 1;
            else
                semcontrol = 0;
            break;

#ifdef PARALLEL_UPDATES
        case 'i':
            updatePair = atoi (argv[++loopvar]);
#endif
#ifdef UF2DEBUG
        fprintf (stderr, "updatePair = %d\n",updatePair);
        fflush(stderr);
#endif
        break;

        case 'j':

```

```

        function = atoi (argv[++loopvar]);
#ifdef UF2DEBUG
        fprintf (stderr, "function = %d\n",function);
        fflush(stderr);
#endif
        break;

        case 'k':
            updateStream = atoi (argv[++loopvar]);
#ifdef UF2DEBUG
            fprintf (stderr, "updateStream = %d\n",updateStream);
            fflush(stderr);
#endif
            break;

        case 'x':
            /*DEL jen -x is chunk*/
            deleteChunk = atoi (argv[++loopvar]); /* to delete for this */
#ifdef UF2DEBUG
            fprintf (stderr, "DelChunk = %d\n",deleteChunk);
            fflush(stderr);
#endif
            break; /* invocation */

        case 'z':
            running_updates = 1;
            break;
#endif
        default :
            fprintf(stderr,"An invalid option has been set\n");
            display_usage();
            break;

    } /* end switch */
} /* end if */

    loopvar ++;
} /* end while */

/* checking if -u option is set */
if (g_struct->c_l_opt->update == -1) {
    fprintf(stderr, "-u option is not set, exiting ... \n");
    exit(-1);
}

#ifdef PARALLEL_UPDATES
    if (running_updates) {
        if (updatePair == -1) {
            fprintf (stderr, "The parameters to tpcdbatch have not been
passed correctly\n");
            exit (-1);
        }
        else {
            /* check to see if we are to use copy on for the load */
            if (( getenv("TPCD_LOG") != NULL ) &&
                (strcmp(uppercase(getenv("TPCD_LOG")), "YES")))
            ) {
                /* okay, we have set LOG_RETAIN on so we need to use copy
directory */
                copyOnOrOff = TRUE;
            }
            else
            {
                /* log retain off don't use copy directory */
                copyOnOrOff = FALSE;
            }
        }

        if (function == 1)
            /* runUF1_fn (updatePair, updateStream); aph 981205 */

```

```

            runUF1_fn (updatePair, updateStream, dbname, userid,
passwd);
        else
            if (function == 2) {
                fprintf(stderr, "A-Calling runUF2_fn %d %d %d ... \n",
                    updatePair, updateStream, deleteChunk);
                /* runUF2_fn (updatePair, updateStream, deleteChunk); aph
981205 */
                runUF2_fn (updatePair, updateStream, deleteChunk, dbname,
userid, passwd);
            }
            else {
                fprintf (stderr, "Wrong function to tpcdbatch\n");
                exit (-1);
            }
            exit (0);
        }
    }
#endif /* PARALLEL_UPDATES */

    /* If no database name is given, then use the one specified in the
environment variable DB2DBDFT, otherwise error */
    if (!strcmp(dbname,"0")) {
        testptr = getenv("DB2DBDFT");
        if (testptr == NULL) {
            fprintf(stderr, "\nNo database name has been specified on
command ");
            fprintf(stderr, "line\nnor in environment variable DB2DBDFT.");
            display_usage();
        }
        else
            strcpy(dbname,testptr);
    }

    if (g_struct->c_l_opt->outfile &&
        !strcmp(g_struct->c_l_opt->str_file_name,"0")) {
        fprintf(stderr, "\nMust specify input file for statement list.\n");
        display_usage();
    }
}

/*****
/* Converts DECIMAL values to ASCII text */
/*****
int sqlrxd2a(
    /*kmw*/
    /* C++ */char *decptr,
    /* C++ */char *asciiptr,
    short prec,
    short scal)
{
    int allzero = TRUE;
    /* C++ */char *srcptr;
    unsigned char sign;
    /* C++ */char *targptr, decimal_point = '!';
    int rc = 0; /*kmw*/
    int tmpint, src_nibble;
    int count, j, limit[3];

    targptr = &asciiptr[ prec + 1];
    *(1 + targptr) = '\0';
    srcptr = decptr + prec/2;

    /* Validity check sign nibble */
    if (((sign = sqlrx_get_right_nibble( *srcptr )) < 0x0a)
        || (prec > SQL_MAXDECIMAL) || (prec < scal ))

```

```

{
    goto exit;
}/** end end if invalid sign value **/

limit[ 0 ] = scal; limit[ 1 ] = prec - scal; limit[ 2 ] = 0;
src_nibble = LEFT;
for( j = 0 ; j < 2 ; j++ )
{
    for( count = limit[ j ] ; count > 0 ; count-- )
    {
        tmpint = ( (src_nibble == LEFT)?
            sqlrx_get_left_nibble( *srcptr-- ) :
            sqlrx_get_right_nibble( *srcptr ) );
        if( tmpint > 9 )
        {
            goto exit;
        }
        else
        {
            *targptr-- = (/* C++ */char)tmpint + '0';
            src_nibble = ((src_nibble == LEFT) ? RIGHT : LEFT);
            if ( tmpint != 0 ) allzero = FALSE;
        }/** end for scal > 0 **/

        if( j == 0 )
            *targptr-- = decimal_point;
        else
            *targptr = (/* C++ */char)((allzero
                || (sign == SQLRX_PREFERRED_PLUS)
                || (sign == 0x0a)
                || (sign == 0x0e)
                || (sign == 0x0f) ?
                '+' : '.' );
    }/** end for limit[ j++ ] > 0 **/

    exit :
    if( rc < 0 )
    {
        printf ("The decimal conversion has failed\n");
        exit (-1);
    }

    return(rc);
}/** sqlrx2a **/

/*****
/* Does some setup and initialization like parsing command line */
/* and connecting to database. Returns process id of agent. */
/*****

void init_setup(int argc, char *argv[], struct global_struct *g_struct)
{
    int connect=0;
#ifdef SQLWINT
    char *pid;
#endif
    char temparray[256]="\0";
    int loopvar=0;
    FILE *updateFP;
    FILE *fpSeed;
    char file_name[256] = "\0";
    short seedEntry;
    long lSeed;
    int i;

    /** Parse and process command line options **/
    comm_line_parse (argc,argv,g_struct);

```

```

/*****
/* Start the mainline report processing. */
/*****
    if (!strcmp(g_struct->c_l_opt->infile, "\0")) {
        instream=stdin;
    }
    else {
        instream=NULL;
        if ( ( instream = fopen(g_struct->c_l_opt->infile, READMODE) ) ==
        NULL ) {
            fprintf(outstream, "The input file could not be opened.\n\n");
            fprintf(stdout, "Make sure that the filename is correct.\n\n");
            fprintf(stdout, "filename = %s\n", g_struct->c_l_opt->infile);
            exit(-1);
        }
        /** open the input file if specified */
    }

    /** IMPORT (begin) - determine whether we should use the IMPORT
    api or */
    /** LOAD api for loading into the staging tables, default is load */
    if (env_tpcd_update_import != NULL)
    {
        if (!strcmp(uppercase(env_tpcd_update_import), "TRUE"))
        {
            ilimportStagingTbl = 1; /* use import */
        }
        /** DJD */
        else if (!strcmp(uppercase(env_tpcd_update_import), "TF"))
        {
            ilimportStagingTbl = 2; /* Table Functions */
        }
    }

    /** IMPORT (end) */

    /** we want to print the seed in the output files to show what seed was
    */
    /** used to generate the queries. */
    /** if intStreamNum is -1 then we are running a qualification database
    */
    /** and the default seed has been used so skip this section */
    if (g_struct->c_l_opt->intStreamNum >= 0)
    {
        /** check to make sure the TPCD_RUNNUMBER environment
        variable is set. We */
        /** use this and the stream number to determine which seed was
        used to */
        /** generate the current set of queries */
        if (getenv("TPCD_RUNNUMBER") == NULL)
        {
            fprintf(stderr, "\n\nThe TPCD_RUNNUMBER environment variable
            is not set");
            fprintf(stderr, "....exiting\n");
            exit(-1);
        }
        if (getenv("TPCD_NUMSTREAM") == NULL)
        {
            fprintf(stderr, "\n\nThe TPCD_NUMSTREAM environment variable
            is not set");
            fprintf(stderr, "....exiting\n");
            exit(-1);
        }
    }

    /**
    * SEED jen
    * we want to print the seed used in the output files. For the seed
    usage

```

```

* we can now reuse the seeds from run to run, therefore all the
power runs
* will use the 1st seed in the file, and the throughput streams will
use
* the 2nd to #streams+1 seeds.
* determine the seed to use...e.g. given 3 streams will have the
following:
*
*           Entry in seed file
* TEST      Stream Number  Run 1  Run 2
* power     0              1      1
* throughput 1             2      2
*           2              3      3
*           3              4      4
*****/
seedEntry = g_struct->c_l_opt->intStreamNum + 1;
/* end SEED jen */
/* open the generated seed file...if not there, try the default */

sprintf(file_name, "%s%s%sauditruns%smseedme",
env_tpcd_audit_dir,
env_tpcd_path_delim, env_tpcd_path_delim);

if ((fpSeed = fopen(file_name,READMODE)) == NULL )
{
fprintf(stderr, "\nCannot open the seed file, please ensure that\n");
fprintf(stderr, "the file exists. filename = %s\n", file_name);
exit(-1);
}
for (i = 1; i <= seedEntry; i++)
{
if (feof(fpSeed))
{
ISeed = -1; /* seed not available for some reason */
}
fscanf(fpSeed, "%ld\n", &ISeed);
}
g_struct->ISeed = ISeed;
fclose(fpSeed);
}

/* check to see if we are to use copy on for the load */
if ((getenv("TPCD_LOG") != NULL ) &&
( !strcmp(uppercase(getenv("TPCD_LOG")), "YES")))
{
/* okay, we have set LOG_RETAIN on so we need to use copy
directory */
g_struct->copy_on_load = TRUE;
}
else
{
/* log retain off don't use copy directory */
g_struct->copy_on_load = FALSE;
}
}

/*****
/* Make sure that DB2 is started. */
/* CONNECT now unless this is a UF stream for a Throughput test. */
/* (aph 98/12/22) */
*****/

if (g_struct->c_l_opt->update > 1)
{
/* This is an update function stream in a throughput run. */
/* Just make sure that DB2 is started. Each UF child will
CONNECT itself. */
if (verbose) fprintf(stderr, "\nStarting the DB2 Database Manager
Now\n");
/* sqlestar (); TMPkmw */
}
else

```

```

{ /* In all other cases, CONNECT to the target database. */
do
{
if (!strcmp(userid, "0")) /** No authentication provided **/
EXEC SQL CONNECT TO :dbname;
else EXEC SQL CONNECT TO :dbname USER :userid USING
:passwd;
if (sqlca.sqlcode == SQLE_RC_NOSTARTG) {
if (verbose)
fprintf(stderr, "\nStarting the DB2 Database Manager Now\n");
sqlestar ();
connect=0;
}
else connect=1;
} while (!connect);
error_check();
}

/*****
* All session initialization is performed at connect time or immediately
*
* following and is complete before starting the stream. *
*****/

/** Get start timestamp for stream **/
get_start_time(&(g_struct->stream_start_time)); /* TIME_ACC
jen*/
strcpy(g_struct->file_time_stamp,
get_time_stamp(T_STAMP_FORM_2, &(g_struct-
>stream_start_time))); /* TIME_ACC jen*/

if (getenv("TPCD_RUN_DIR") != NULL)
strcpy(g_struct->run_dir, getenv("TPCD_RUN_DIR"));
else
strcpy(g_struct->run_dir, ".");

/* if we are running a throughput test, then we must report the */
/* stream count information...we will report one file per stream */
/* and amalgamate them after all streams have completed */
/* if the number of streams is greater than 0 then this is a throughput
test*/
switch (g_struct->c_l_opt->update)
{
case (2):
case (5):
/* update throughput function stream */
sprintf(file_name, "%s%s%ssstrcntuf.%s", g_struct->run_dir,
env_tpcd_path_delim, g_struct->file_time_stamp);
break;
case (3):
case (4):
/* update power function stream */
sprintf(file_name, "%s%s%spstrcntuf.%s", g_struct->run_dir,
env_tpcd_path_delim, g_struct->file_time_stamp);
break;
case (1):
/* power query stream */
sprintf(file_name, "%s%s%spstrcnt%d.%s", g_struct->run_dir,
env_tpcd_path_delim,
g_struct->c_l_opt->intStreamNum, g_struct-
>file_time_stamp);
break;
case (0):
/* throughput query stream */
sprintf(file_name, "%s%s%ssstrcnt%d.%s", g_struct->run_dir,
env_tpcd_path_delim,
g_struct->c_l_opt->intStreamNum, g_struct-
>file_time_stamp);
break;
}

```

```

}

if( (g_struct->stream_report_file = fopen(file_name, WRITEMODE))
== NULL )
{
    fprintf(stderr, "\nThe output file for the stream count information\n");
    fprintf(stderr, "could not be opened, make sure the filename is
correct\n");
    fprintf(stderr, "filename = %s\n", file_name);
    exit(-1);
}

if (g_struct->c_l_opt->update > 1)
{
    /* update function stream */
    fprintf(g_struct->stream_report_file,
        "Update function stream starting at %*. *s\n",
        T_STAMP_3LEN, T_STAMP_3LEN, /* TIME_ACC jen*/
        get_time_stamp(T_STAMP_FORM_3, &(g_struct-
>stream_start_time))); /* TIME_ACC jen*/
}
else
{
    /* query stream */
    fprintf(g_struct->stream_report_file,
        "Stream number %d starting at %*. *s\n",
        g_struct->c_l_opt->intStreamNum,
        T_STAMP_3LEN, T_STAMP_3LEN, /* TIME_ACC jen*/
        get_time_stamp(T_STAMP_FORM_3, &(g_struct-
>stream_start_time))); /* TIME_ACC jen*/
}

#ifdef LINUX

    fclose(g_struct->stream_report_file);

#endif

    /* set up the update_num_file name so that if we do use
semaphores, */
    /* we will have a filename to generate the semkey */

    sprintf(g_struct->update_num_file, "%s%s%s.%s.update.pair.num",
env_tpcd_audit_dir,
        env_tpcd_path_delim, uppercase(env_tpcd_dbname),
lowercase(env_user));
    sprintf(g_struct->sem_file, "%s.%s.semfile", env_tpcd_dbname,
env_user);
    if (g_struct->c_l_opt->intStreamNum == 0)
    {
        sprintf(g_struct->sem_file2, "%s.%s.semfile2", env_tpcd_dbname,
env_user);
    }
    if (verbose) { /* print out the update pair number file for debugging */
        fprintf(stderr, "\n init_setup: strem %d update pair numb file = %s\n",
            g_struct->c_l_opt->intStreamNum, g_struct->update_num_file);
    }

    /* update the
$TPCD_AUDIT_DIR/$TPCD_DBNAME.$USER.update.pair.num file */
    /* update pairs have been run */
    if ((g_struct->c_l_opt->update >= 1) && (g_struct->c_l_opt->update
< 4))
        /* on or onl, but not */ /* bbe or > 1 */
    {
        updateFP = fopen(g_struct->update_num_file, "r");
        if (updateFP != NULL )
        {
            fscanf(updateFP, "%d", &updatePairStart);
            fclose(updateFP);

```

```

        if (g_struct->c_l_opt->intStreamNum == 0) /* on, 1 update pair */
            updatePairStop = updatePairStart + 1;
        else /* only, multiple update pairs, stream number will be
total */
            updatePairStop = updatePairStart + g_struct->c_l_opt-
>intStreamNum;
        currentUpdatePair = updatePairStart;

        if (updatePairStart <= 0)
        {
            fprintf(stderr, "updatePairStart is bogus!");
            exit(-1);
        }
    }
    else
    {
        fprintf(stderr, "\n %s not set up, set this \n", g_struct-
>update_num_file);
        fprintf(stderr, "file to contain the number of the update pair to \n");
        fprintf(stderr, "run and resubmit\n");
        exit(-1);
    }
}

return ;
}

/*****
/* A function to print out the column titles for a returned set */
/*****
void print_headings (struct sqllda *sqllda, int *col_lengths)
{
    int col = 0; /* Column number */
    int col_width = 0; /* width of column */
    int max_col_width = 0; /* maximum column width */
    int col_name_length = 0; /* sizeof column name string */
    int col_type = 0; /* column type */

    int total_length = 0; /* accumulator var. for
length of column headings */

    int loopvar = 0;

    char col_name[256] = "\0";
    unsigned char m, n; /* precision and accuracy
for decimal conversion */

    fprintf (outstream, "\n");

    /** loop through for each column in solution set
and determine the maximum column width */

    for (col = 0; col < sqllda->sqlld; col++) {
        col_name_length = sqllda->sqlvar[col].sqlname.length;
        col_type = sqllda->sqlvar[col].sqltype;
        col_width = sqllda->sqlvar[col].sqllen;
        strncpy(col_name, (char *)sqllda-
>sqlvar[col].sqlname.data, col_name_length);

        switch (col_type)
        {
            case SQL_TYP_SMALL:
            case SQL_TYP_NSMALL: /* @d30369 tlg */
                col_lengths[col] = TPCDBATCH_MAX (col_name_length, 6);
                break;
            case SQL_TYP_INTEGER:
            case SQL_TYP_NINTEGER:
                col_lengths[col] = TPCDBATCH_MAX (col_name_length, 11);
                break;
            case SQL_TYP_BIGINT: /* kmwBIGINT */

```

```

case SQL_TYP_NBIGINT:
    col_lengths[col] = TPCDBATCH_MAX (col_name_length,19);
    break;
case SQL_TYP_CSTR:
case SQL_TYP_NCSTR:
case SQL_TYP_DATE:
case SQL_TYP_NDATE:
case SQL_TYP_TIME:
case SQL_TYP_NTIME:
case SQL_TYP_STAMP:
case SQL_TYP_NSTAMP:
case SQL_TYP_CHAR:
case SQL_TYP_NCHAR:
case SQL_TYP_VARCHAR:
case SQL_TYP_NVARCHAR:
case SQL_TYP_LONG:
case SQL_TYP_NLONG:
    col_lengths[col] = TPCDBATCH_MAX
(col_name_length,col_width);
    break;

case SQL_TYP_FLOAT:
case SQL_TYP_NFLOAT:
    /* kmw - note: TPCDBATCH_PRINT_FLOAT_WIDTH > max long
identifier */
    col_lengths[col] = TPCDBATCH_PRINT_FLOAT_WIDTH;
    break;

case SQL_TYP_DECIMAL:
case SQL_TYP_NDECIMAL:

    m=*(struct declen *)&sqlda->sqlvar[col].sqlen).m;
    n=*(struct declen *)&sqlda->sqlvar[col].sqlen).n;

    col_lengths[col] = TPCDBATCH_MAX ((int)(m+n),
col_name_length);
    /* Special handling for DECIMAL */ /* @d26350 tjg */
    break;

default:
    fprintf(stderr,"--Unknown column type (%d).
Aborting.\n",col_type);
    break;
}

fprintf(outstream,"%-*s
",col_lengths[col],col_name_length,col_name);

total_length += (col_lengths[col] + 2); /* 2 is from padding spaces
*/
}

fprintf(outstream,"\n");
for (loopvar=0; loopvar < total_length; loopvar++)
    fprintf(outstream,"-");
fprintf(outstream,"\n");
}

/*****
/* Gets the current system time and prints it out
*****/
char *get_time_stamp(int form, Timer_struct *time_pointer)
{
    Timer_struct temp_stamp; /* TIME_ACC jen */
    struct tm *tp;
    size_t timeLength = 0;

    /* TIME_ACC jen start */

```

```

if (time_pointer == (Timer_struct *)NULL)
    get_start_time(&temp_stamp);
else
    temp_stamp = *time_pointer;

#if defined (SQLUNIX) || defined (SQLAIX)
    tp = localtime((time_t *)&(temp_stamp.tv_sec));
#elif (defined (SQLOS2) || defined (SQLWINT) || defined (SQLWIN) ||
defined (SQLDOS))
    tp = localtime(&(temp_stamp.time));
#else
#error Unknown operating system
#endif
    /* TIME_ACC jen stop */

    if ((form == T_STAMP_FORM_1) || (form == T_STAMP_FORM_3))
    {
        /* SUN fix bbe start */
        #if (defined (SQLWINT) || defined (SQLWIN) || defined (SQLOS2) ||
defined (SQLDOS))
            timeLength = strftime(newtime,50,"%x %X",tp);
        #elif (defined (SQLUNIX) || defined (SQLAIX))
            timeLength = strftime(newtime,50,"%D %T",tp); /* SUN ...test this
*/
        #else
#error Unknown operating system
#endif
        /* SUN fix bbe stop */
        /* TIME_ACC jen start */
        if (form == T_STAMP_FORM_3)
        {
            /* concatenate the microsecond/milliseconds on the end of the */
            /* timestamp jen1006 */
            #if defined (SQLUNIX) || defined (SQLAIX)
                sprintf(newtime+timeLength,"%0.6d",temp_stamp.tv_usec);
            #elif (defined (SQLOS2) || defined (SQLWINT) || defined (SQLWIN) ||
defined (SQLDOS))
                sprintf(newtime+timeLength,"%0.3d",temp_stamp.millitm);
            #else
#error Unknown operating system
#endif
        }
        /* TIME_ACC jen stop */
    }
    else
        if (form == T_STAMP_FORM_2)
            strftime(newtime,50,"%y%m%d-%H%M%S",tp);

    return (newtime);
}

/*****
/* Handle all the processing for the summary table
*****/

void summary_table (struct global_struct *g_struct)
{
    double arith_mean = 0;
    double geo_mean = 0;
    int num_stmt = 0;
    int num_stmt_for_geo_mean = 0;

    double adjusted_a_mean = 0;
    double adjusted_g_mean = 0;
    double adjusted_g_mean_intern;
    double adjusted_max_time = 0;

```



```

double Ts = 0;          /* different TPC-D metrics */
double Ts1;
double Ts2;
/* double QppD = 0;      MARK
double QthD = 0;
double QphD = 0; */

double db_size_frac_part = 0; /* stores the fractional part of db
size */
double db_size = 0;          /* size in numbers */
char db_size_qualifier[3] = "\0"; /* MB, GB or TB */

struct stmt_info
*s_info_ptr,
*s_info_head_ptr,
*max,
*min;

/* Determine the size of the database from the scale factor (1 SF =
1GB) */
if (g_struct->scale_factor < 1.0) {
    db_size = g_struct->scale_factor * 1000;
    strcpy(db_size_qualifier, "MB");
} else if (g_struct->scale_factor >= 1000.0) {
    db_size = g_struct->scale_factor / 1000;
    strcpy(db_size_qualifier, "TB");
} else {
    db_size = g_struct->scale_factor;
    strcpy(db_size_qualifier, "GB");
}

/* computes the fractional part of db_size */
db_size_frac_part = db_size - (int) db_size;

s_info_ptr = g_struct->s_info_ptr; /* Just use a local copy */
s_info_head_ptr = s_info_ptr;

max = s_info_head_ptr;
/* ensure that we are not already setting max to the UF timings */
while ( strstr(max->tag, "UF") != NULL )
    max = max->next;
min = max;

if (g_struct->c_l_opt->outfile) /* create the appropriate output file */
    output_file(g_struct);

/* write the seed used for this run unless it is a qualification run */
/* (qualification runs use the default seed for their queries) or */
/* unless it is the update function stream (no seeds used for this) */
/* (this is an update stream iff update is 2) */
if ((g_struct->c_l_opt->intStreamNum >= 0) &&
    (g_struct->c_l_opt->update != 2) )
{
    if (g_struct->lSeed == -1)
    {
        fprintf( ostream, "\nUsing default qgen seed file");
    }
    else
        fprintf( ostream, "\nSeed used for current run = %ld", g_struct-
>lSeed);
    fprintf( ostream, "\n");
}

/* print out the stream number if we are in a throughput stream and if
*/
/* this is not the update stream portion of the throughput test */
if ( (g_struct->c_l_opt->intStreamNum > 0) &&
    (g_struct->c_l_opt->update != 2) )

```

```

{
    fprintf( ostream, "Stream number = %d\n", g_struct->c_l_opt-
>intStreamNum);
}
/* print the stream start timestamp to the inter file */
fprintf( ostream, "Stream start time stamp %*.s\n",
    T_STAMP_3LEN, T_STAMP_3LEN, /* TIME_ACC jen*/
    get_time_stamp(T_STAMP_FORM_3, &(g_struct-
>stream_start_time))); /* TIME_ACC jen*/
/* print the stream stop timestamp to the inter file */
fprintf( ostream, "Stream stop time stamp %*.s\n",
    T_STAMP_3LEN, T_STAMP_3LEN, /* TIME_ACC jen*/
    get_time_stamp(T_STAMP_FORM_3, &(g_struct-
>stream_end_time))); /* TIME_ACC jen*/

fprintf( ostream, "\n\nSummary of
Results\n=====");
fprintf( ostream,
    "\nSequence #   Elapsed Time   Adjusted Time Start
Timestamp   End Timestamp\n\n");

/* Go through the linked list and determine which statement had the
highest and lowest elapsed times */
while ( (s_info_ptr != NULL) && (s_info_ptr != g_struct-
>s_info_stop_ptr) ) {

    /* check if we are in an update function...if so, we do not want to */
    /* consider the update function times as the min or max time */
    if ( strstr(s_info_ptr->tag, "UF") == NULL )
    {
        /* we are not in an update function */
        if (s_info_ptr->elapsed_time > max->elapsed_time)
            max = s_info_ptr;
        else
            if ((s_info_ptr->elapsed_time < min->elapsed_time)
                && (s_info_ptr->elapsed_time > -1))
                min = s_info_ptr;
    }

    s_info_ptr = s_info_ptr->next;
}

s_info_ptr = s_info_head_ptr;

/** Start from the first structure and go through until the stop
pointer is reached */
while ( (s_info_ptr != NULL) && (s_info_ptr != g_struct-
>s_info_stop_ptr) ) {

    if (s_info_ptr->elapsed_time != -1) {
        s_info_ptr->adjusted_time = s_info_ptr->elapsed_time;
        /* determine whether the elapsed times have to be adjusted or
not */
        /* if this is an update function, we do not adjust the elapsed time*/
        if ( strstr(s_info_ptr->tag, "UF") == NULL )
        {
            /* this is not an update function, adjust time if necessary */
            if (max->elapsed_time/min->elapsed_time > 1000)
            {
                /* jmc fix geo_mean calculation...round adjusted time properly
ROUNDING*/
                adjusted_max_time = max->elapsed_time/1000;
                if (s_info_ptr->elapsed_time < adjusted_max_time)
                {
                    s_info_ptr->adjusted_time =
                        (double)((long)((adjusted_max_time + 0.05) * 10))/10.0;
                    if (s_info_ptr->adjusted_time < 0.1)
                        s_info_ptr->adjusted_time = 0.1;
                }
            }
        }
    }
}

```

```

        /*jmc fix geo_mean calculation...round adjusted time properly
ROUNDING end*/
    }
}

        /* a value was calculated */
fprintf (outstream,
        "%-5d %-5.5s %15.1f %15.1f %*.*s %*.*s\n",
        s_info_ptr->stmt_num,s_info_ptr->tag,
        s_info_ptr->elapsed_time,s_info_ptr->adjusted_time,
        T_STAMP_1LEN,T_STAMP_1LEN,s_info_ptr-
>start_stamp, /* TIME_ACC jen*/
        T_STAMP_1LEN,T_STAMP_1LEN,s_info_ptr-
>end_stamp); /* TIME_ACC jen*/

/* Only update arithmetic mean for queries not update functions */
if ( strstr(s_info_ptr->tag,"UF") == NULL )
{
    arith_mean += s_info_ptr->elapsed_time;
    adjusted_a_mean += s_info_ptr->adjusted_time;
}

if (s_info_ptr->elapsed_time > 0) { /* don't bother finding log of
    numbers < 0 */
    geo_mean += log(s_info_ptr->elapsed_time);
    adjusted_g_mean += log(s_info_ptr->adjusted_time);
}

/* Only update num_stmt for queries not update functions */
if ( strstr(s_info_ptr->tag,"UF") == NULL )
    num_stmt ++;
    num_stmt_for_geo_mean++;
}

else
    fprintf (outstream,"%-5d %-5.5s %-15s %-15s\n",
        s_info_ptr->stmt_num,
        s_info_ptr->tag,"Not Collected", "Not Collected");

if (s_info_ptr != g_struct->s_info_stop_ptr)
    s_info_ptr=s_info_ptr->next;
}

fprintf(outstream, "\n\nNumber of statements: %d\n\n", s_info_ptr-
>stmt_num - 1);
/* Calculate the arithmetic and geometric means */

if (geo_mean != 0) { /*Used to test if arith_mean != 0
    Don't bother doing any of this if the
    elapsed time mean is 0 */
    arith_mean = arith_mean / num_stmt;
    adjusted_a_mean = adjusted_a_mean / num_stmt;
    geo_mean = exp(geo_mean / num_stmt_for_geo_mean);
    adjusted_g_mean_intern = adjusted_g_mean; /*MARK*/
    adjusted_g_mean = exp(adjusted_g_mean /
num_stmt_for_geo_mean);
}

/* print out all the appropriate information including the
different TPC-D metrics */
/* do not bother with this if we are in an update only stream */
fprintf (outstream, "\nGeom. mean queries %7.3f %15.3f\n",\
        geo_mean,adjusted_g_mean);
if (g_struct->c_l_opt->update < 2)
{
    fprintf (outstream, "Arith. mean queries %7.3f %15.3f\n",\

```

```

        arith_mean,adjusted_a_mean);

    fprintf (outstream,
        "\n\nMax Qry %-3.3s %15.1f %15.1f %*.*s %*.*s\n",
        max->tag,max->elapsed_time,max->adjusted_time,
        T_STAMP_1LEN,T_STAMP_1LEN,max->start_stamp, /*
TIME_ACC jen*/
        T_STAMP_1LEN,T_STAMP_1LEN,max->end_stamp); /*
TIME_ACC jen*/
    fprintf (outstream,
        "Min Qry %-3.3s %15.1f %15.1f %*.*s %*.*s\n",
        min->tag,min->elapsed_time,min->adjusted_time,
        T_STAMP_1LEN,T_STAMP_1LEN,min->start_stamp, /*
TIME_ACC jen*/
        T_STAMP_1LEN,T_STAMP_1LEN,min->end_stamp); /*
TIME_ACC jen*/
}

if (g_struct->c_l_opt->intStreamNum == 0) {
    /* fprintf (outstream, "\n\nMetrics\n=====\n\n"); */

    /* Increase the Ts measurement by one second since the accuracy
of our */
    /* timestamps is only to 1 second and if the start was at 1.01
seconds, */
    /* and the end was at 5.99 seconds, we get a free second ... this
will */
    /* be made explicit in the upcoming revision of the spec (after 1.0.1)
*/
    /* TIME_ACC jen start*/
    /* NOTE this can probably be better coded by changing
get_elapsed_time */
    /* to just calculate the elapsed time give a start and an end time,
and */
    /* to also give a precision for the calculation (sec, 10ths...). The */
    /* call then will grab a timestamp before calling. Then we can get
rid */
    /* of the if def...and just call get_elapsed_time (whcih can handle
the */
    /* os differences on its own */

#ifdef (SQLUNIX) || defined (SQLAIX)
    Ts = g_struct->stream_end_time.tv_sec - g_struct-
>stream_start_time.tv_sec + 1;
    Ts1 = (double)g_struct->stream_start_time.tv_sec +
((double)g_struct->stream_start_time.tv_usec/1000000);
    Ts2 = (double)g_struct->stream_end_time.tv_sec +
((double)g_struct->stream_end_time.tv_usec/1000000);

#elif (defined (SQLOS2) || defined (SQLWINT) || defined (SQLWIN) ||
defined (SQLDOS))
    Ts = g_struct->stream_end_time.time - g_struct-
>stream_start_time.time + 1;
    Ts1 = (double)g_struct->stream_start_time.time +
((double)g_struct->stream_start_time.millitm/1000);
    Ts2 = (double)g_struct->stream_end_time.time + ((double)g_struct-
>stream_end_time.millitm/1000);

#else
#error Unknown operating system
#endif

    /* TIME_ACC jen stop*/

/* MARK
##Now do in calcmetricsp.pl###
QppD = (3600 * g_struct->scale_factor) / adjusted_g_mean;
QthD = (num_stmt * 3600 * g_struct->scale_factor) / Ts;
QphD = sqrt(QppD*QthD);

```

```

*/
/* if the decimal part has some meaningful value then print the
database size
with decimal part; otherwise just print the integer part */

fprintf (outstream,
        "\nGeometric mean interim value = %10.3f\n\nStream Ts
%11 = %10.0f\n\nStream start int representation %11 = %f\n\nStream
stop int representation %11 = %f",
        adjusted_g_mean_intern,Ts,Ts1,Ts2);
}
}

/*****
/* free up all the elements of the sqlda after done processing */
/*****
void free_sqlda (struct sqlda *sqlda, int select_status) /* @d30369 tjg
*/
{
    int loopvar;

    if (select_status == TPCDBATCH_SELECT)
        for (loopvar=0; loopvar<sqlda->sqlld; loopvar++) {
            free(sqlda->sqlvar[loopvar].sqldata);
            free(sqlda->sqlvar[loopvar].sqlind);
        }

    free(sqlda);
    sqlda_allocated = 0; /* fix free() problem on NT
        wlc 090597 */
}

/*****
/* processing to run the insert update function */
/*****
void runUF1 ( struct global_struct *g_struct, int updatePair )
{

    char statement[3000];
    char sourcedir[256];

    int split_updates = 2; /* no. of ways update records are split */
    int concurrent_inserts = 2; /* jenCI no of concurrent updates to be */
        /* jenCI run at once*/
    int loop_updates = 1; /* jenCI no of updates to be run in one */
        /* jenCI "concurrent" invocation. should*/
        /* jenCI be split_updates / concurrent_inserts*/

    int i;
    int streamNum;
#ifdef SQLWINT
    /* PROCESS_INFORMATION childprocess[100]; */
    char commandline[256];
    HANDLE su_hSem;
    char UF1_semfile[256];
#else
    int childpid[100];
    int su_sem; /* semaphore for controlling split updates*/
    key_t su_semkey; /* key to generate semid */
#endif
    if (g_struct->c_l_opt->intStreamNum == 0)
        streamNum = 0;
    else
        streamNum = currentUpdatePair - updatePairStart + 1;

    fprintf( outstream,"UF1 for update pair %d, stream %d,
starting\n",updatePair, streamNum);

```

```

/* Start by loading the data into the staging table at each node */
/* The orderkeys were split earlier by the split_updates program */
if (env_tpcd_audit_dir != NULL)
    strcpy(sourcedir,env_tpcd_audit_dir);
else
    strcpy(sourcedir,".");

/* Load the orderkeys into the staging table */
/* In SMP environments one could use a load command but by using
a */
/* script we can keep the code common */
#ifdef SQLWINT
    sprintf (statement, "perl %s\tools\ploaduf1 %d\n", sourcedir,
updatePair);
#else
    sprintf (statement, "perl %s/tools/ploaduf1 %d 1", sourcedir,
updatePair);
#endif
if (system(statement))
    {
        fprintf (stderr, "ploaduf1 failed for UF1, examine UF1.log for cause.
Exiting.\n");
        if (verbose)
            fprintf (stderr,
                "ploaduf1 failed for UF1, examine UF1.log for cause.
Exiting.\n");
        exit (-1);
    }

    fprintf (outstream, "load_update finished for UF1.\n");

    if (getenv ("TPCD_SPLIT_UPDATES") != NULL)
        split_updates = atoi (getenv ("TPCD_SPLIT_UPDATES"));
    if (getenv ("TPCD_CONCURRENT_INSERTS") != NULL)
/*jenCI*/
        concurrent_inserts = atoi (getenv
("TPCD_CONCURRENT_INSERTS")); /*jenCI*/
        loop_updates = split_updates / concurrent_inserts;
/*jenCI*/

#ifdef SQLWINT
    /* we will use the tpcd.setup file to generate the semaphore key */
    if (getenv("TPCD_AUDIT_DIR") != NULL) /*begin SEMA */
    {
        /* this is assuming that you will be running this from 0th node */
        sprintf(sourcefile, "%s%ctools%ctpcd.setup",
            getenv("TPCD_AUDIT_DIR"), PATH_DELIM,PATH_DELIM);
    }
    else
    {
        fprintf (stderr, "runUF1 Can't open UF1 semaphore
file,TPCD_AUDIT_DIR is not defined.\n");
        exit (-1);
    }
    /*end SEMA */
    su_semkey = ftok (sourcefile, 'J');
    if ((su_sem = semget (su_semkey, 1,
IPC_CREAT|S_IRUSR|S_IWUSR)) < 0)
    {
        fprintf (stderr, "Cannot get semaphore! semget failed: errno =
%d\n",errno);
        exit (-1);
    }
#else /* SQLWINT */
    sprintf (UF1_semfile, "%s.%s.UF1.semfile", env_tpcd_dbname,
env_user);
    su_hSem = CreateSemaphore(NULL, 0,
        concurrent_inserts, /*jenCI*/
        (LPCTSTR)(UF1_semfile));

```

```

if (su_hSem == NULL)
{
    fprintf(stderr,
        "CreateSemaphore (ready semaphore) failed, GetLastError:
%d, quitting\n",
        GetLastError());
    exit(-1);
}
#endif /* SQLWINT */
if (verbose) fprintf(stderr, "Semaphore created successfully!\n");

fclose(outstream); /* to prevent multiple header caused by forking
wlc 081397 */

for (i=0; i < concurrent_inserts; i++) /*jenCI*/
{
#ifdef SQLWINT
    if ((childpid[i] = fork()) == 0)
    {
        /* runUF1_fn (updatePair, i); aph 981205 */
        runUF1_fn (updatePair, i, dbname, userid, passwd);
    }
    else
    {
        /* This is the parent */
        if (verbose)
            fprintf (stderr, "stream #%d started with pid %d\n", i, childpid[i]);
    }
#else /* SQLWINT */
    sprintf (commandline,
        "start /b %s\auditruns\tpcdbatch.exe -z -d %s -i %d -j 1 -k
%d",
        env_tpcd_audit_dir, dbname, updatePair, i); /* aph 082797 */

    system (commandline);
#endif /* SQLWINT */
    /* sleep (UF1_SLEEP); TMPkmw */
}

/* All children have been created, now wait for them to finish */
#ifdef SQLWINT
if (sem_op (su_sem, 0, concurrent_inserts * -1) != 0)
/*jenCI*/
{
    /*jenSEM*/
    fprintf(stderr,
        "Failure to wait on insert semaphore with %d of children\n",
        concurrent_inserts);
    exit(1);
}
/*jenSEM*/
semctl (su_sem, 0, IPC_RMID, 0);
#else
for (i = 0; i < concurrent_inserts; i++) /*jenCI*/
{
    if (verbose)
    {
        fprintf(stderr, "About to wait again ...Sets to wait for %d\n",
            concurrent_inserts - i); /*jenCI*/
    }
    if (WaitForSingleObject(su_hSem, INFINITE) == WAIT_FAILED)
    {
        fprintf(stderr,
            "WaitForSingleObject (su_hSem) failed in runUF1 on set
%d, error: %d, quitting\n",
            i, GetLastError());
        exit(-1);
    }
}
if (! CloseHandle(su_hSem))
{
    fprintf(stderr,

```

```

"RunUF1 Close Sem failed - Last Error: %d\n",
GetLastError());
/* no exit here */
}
#endif

if( (outstream = fopen(outstreamfilename, APPENDMODE)) == NULL
)
{
    fprintf(stderr, "\nThe output file could not be opened. ");
    fprintf(stderr, "Make sure that the filename is correct.\n");
    fprintf(stderr, "filename = %s\n", outstreamfilename);
    exit(-1);
}

fprintf( outstream, "UF1 for update pair %d complete\n", updatePair);
}

/* runUF1_fn() moved to another SQC file aph 981205 */

/*****
/* processing to run the delete update function */
*****/
void runUF2 ( struct global_struct *g_struct, int updatePair )
{
    char statement[3000];
    char sourcedir[256];

    int split_deletes = 1; /* no. of ways update records are split
@dxxxxxhar */
    int concurrent_deletes = 1; /* number of database partitions
DELjen */
    int chunks_per_concurrent_delete = 1;

    int i;
    int streamNum;
#ifdef SQLWINT
    char commandline[256];
    HANDLE su_hSem;
    char UF2_semaphore[256];
#else
    int childpid[100];
    char sourcefile[256];
    int su_sem; /* semaphore for controlling split updates*/
    key_t su_semkey; /* key to generate semid */
#endif
    if (g_struct->c_l_opt->intStreamNum == 0)
        streamNum = 0;
    else
        streamNum = currentUpdatePair - updatePairStart + 1;

    fprintf( outstream, "UF2 for update pair %d, stream %d,
starting\n", updatePair, streamNum);

    /* We need to know both how many chunks there are and how many
chunks*/
    /* are to be executed by each concurrent UF2 process. More
chunks means */
    /* both smaller transactions (less deadlock) and more potential
concurrency */

    /* How many "chunks" have the orderkeys been divided into? */
    if (getenv ("TPCD_SPLIT_DELETES") != NULL)
        split_deletes = atoi (getenv ("TPCD_SPLIT_DELETES"));
    /* How many deletes should run concurrently */
    if (getenv ("TPCD_CONCURRENT_DELETES") != NULL)
        concurrent_deletes = atoi (getenv
("TPCD_CONCURRENT_DELETES"));

```

```

/* How many chunks in each concurrently running delete process */
chunks_per_concurrent_delete = split_deletes / concurrent_deletes;

/* Start by loading the data into the staging table at each node */
/* The orderkeys were split earlier by the split_updates program */
if (env_tpcd_audit_dir != NULL)
    strcpy(sourcedir,env_tpcd_audit_dir);
else
    strcpy(sourcedir,".");

/* Load the orderkeys into the staging table */
/* In SMP environments one could use a load command but by using
a */
/* script we can keep the code common */

#ifdef SQLWINT
    sprintf (statement, "perl %s\\tools\\ploaduf2 %d\\n", sourcedir,
updatePair);
#else
    sprintf (statement, "perl %s/tools/ploaduf2 %d 2", sourcedir,
updatePair);
#endif
    if (system(statement))
    {
        fprintf (stderr, "ploaduf2 failed for UF2, examine UF2.log for cause.
Exiting.\\n");
        exit (-1);
    }
    fprintf (outstream, "ploaduf2 finished for UF2.\\n");

    fclose(outstream); /* to prevent multiple header caused by forking
wlc 081397 */

/* Next we need to get ready to launch a bunch of concurrent
processes */
#ifdef SQLWINT
/* we will use the tpcd.setup file to generate the semaphore key
begin SEMA */
if (getenv("TPCD_AUDIT_DIR") != NULL)
{
    sprintf(sourcefile, "%s%ctools%ctpcd.setup",
getenv("TPCD_AUDIT_DIR"), PATH_DELIM, PATH_DELIM);
}
else
{
    fprintf (stderr, "runUF2 Can't open UF2 semaphore file,
TPCD_AUDIT_DIR is not defined.\\n");
    exit (-1);
}

su_semkey = ftok (sourcefile, 'D'); /* use D for deletes */
/* end SEMA */
if ( (su_semid = semget (su_semkey, 1,
IPC_CREAT|S_IRUSR|S_IWUSR) < 0)
{
    fprintf (stderr, "UF2 Can't get semaphore! semget failed: errno =
%d\\n",
errno);
    exit (-1);
}
#else
    sprintf (UF2_semfile, "%s.%s.UF2.semfile", env_tpcd_dbname,
env_user);
    fprintf(stderr,"UF2 semfile = %s\\n",UF2_semfile);
    su_hSem = CreateSemaphore(NULL, 0,
concurrent_deletes,
(LPCTSTR)(UF2_semfile));
    if (su_hSem == NULL)

```

```

{
    fprintf(stderr,
        "CreateSemaphore (ready semaphore) failed, GetLastError:
%d, quitting\\n",
        GetLastError());
    exit(-1);
}
}
fprintf(stderr,"Semaphore created successfully!\\n");
#endif

for (i=0; i < concurrent_deletes; i++)
{
#ifdef SQLWINT
    if ((childpid[i] = fork()) == 0)
    {
        fprintf(stderr, "B-Calling runUF2_fn %d %d %d ...\\n",
            updatePair, i, chunks_per_concurrent_delete);
        /* runUF2_fn (updatePair, i, chunks_per_concurrent_delete);
aph 981205 */
        runUF2_fn (updatePair, i, chunks_per_concurrent_delete,
dbname, userid, passwd);
    }
    else
    {
        /* This is the parent */
        if (verbose)
            fprintf (stderr, "stream #%%d started with pid %d\\n", i, childpid[i]);
    }
#else
    {
        /* SECURITY_ATTRIBUTES sec_process;
        SECURITY_ATTRIBUTES sec_thread; */
        /* NEED TO FIX THIS UP - KBS 98/10/20 */

        sprintf (commandline,
            "start /b %s\\auditruns\\tpcbatch.exe -z -d %s -i %d -j 2 -k %d
-x %d",
            env_tpcd_audit_dir, dbname, updatePair, i,
            chunks_per_concurrent_delete ); /* aph */
        /* the -x parm should be passed at 0...not 100% sure of this jen */
        fprintf(stderr, "commandline= %s\\n", commandline);
        system (commandline);
        /* sleep (UF2_SLEEP); TMPkmw */
    }
#endif
}

/* All children have been created, now wait for them to finish */
#ifdef SQLWINT
    fprintf(stderr, "About to wait on the semaphore...\\n");
    if (sem_op (su_semid, 0, concurrent_deletes * -1) != 0)
/*jenSEM*/
    {
        fprintf(stderr,
            "Failure to update wait on delete semaphore with %d
children\\n",
            concurrent_deletes);
        exit(1);
    }
/*jenSEM*/
    semctl (su_semid, 0, IPC_RMID, 0);
#else
    // for (i = 0; i < split_deletes; i++) //DJD Waits forever.....
    for (i = 0; i < concurrent_deletes; i++)
    {
        if (verbose)
        {
            // fprintf(stderr,"About to wait again ...Sets to wait for %d\\n",
            // split_deletes - i);
            // fprintf(stderr,"About to wait again ...Sets to wait for %d\\n",
            concurrent_deletes - i);
        }
    }

```

```

    }
    if (WaitForSingleObject(su_hSem, INFINITE) == WAIT_FAILED)
    {
        fprintf(stderr,
            "WaitForSingleObject (su_hSem) failed on set %d, error:
%d, quitting\n",
            i, GetLastError());
        exit(-1);
    }
    if (! CloseHandle(su_hSem))
    {
        fprintf(stderr, "Close Sem failed - Last Error: %d\n", GetLastError());
        /* no exit here */
    }
#endif

    if ( (outstream = fopen(outstreamfilename, APPENDMODE)) == NULL
)
    {
        fprintf(stderr, "\nThe output file could not be opened. ");
        fprintf(stderr, "Make sure that the filename is correct.\n");
        fprintf(stderr, "filename = %s\n", outstreamfilename);
        exit(-1);
    }

    fprintf(ostream, "UF2 for update pair %d complete\n", updatePair);
}

/* runUF2_fn() moved to another SQC file          aph 981205 */

/*-----*/
/*   General semaphore function.                */
/*-----*/
#ifdef SQLWINT
int sem_op (int semid, int semnum, int value)
{
    struct sembuf sembuf; /* = {semnum ,value,0}; */
    sembuf.sem_num = semnum;
    sembuf.sem_op = value;
    sembuf.sem_flg = 0;

    if (semop(semid, &sembuf, 1) < 0)
    {
        fprintf(stderr, "ERROR*** sem_op errno = %d\n", errno);
        return(-1);
        /* exit(1); */
    }
    return (0); /* successful return jenSEM */
}
#endif

/*-----*/
/* Determines the proper name for the output file to
be generated for a particular TPC-D query, update function, or
interval summary */
/*-----*/
void output_file(struct global_struct *g_struct)
{
    char file_name[256] = "\0";
    char run_dir[150] = "\0";
    char time_stamp[50] = "\0";
    char delim[2] = "\0";
    int qnum;

    strcpy(run_dir, g_struct->run_dir);

```

```

    sprintf(delim, "%s", env_tpcd_path_delim);
    strcpy(time_stamp, g_struct->file_time_stamp);

    if (g_struct->stream_list == NULL)
        if ((g_struct->stream_list =
            fopen(g_struct->c_l_opt->str_file_name, READMODE))
            == NULL)
        {
            fprintf(stderr, "\nThe stream list file could not be opened.");
            fprintf(stderr, "Make sure that the filename is correct.\n");
            exit(-1);
        }

    fscanf(g_struct->stream_list, "%d", &qnum);

    switch (g_struct->c_l_opt->intStreamNum)
    {
        case -1: /* qualifying */
            sprintf(file_name,
                "%s%sqryqual%02d.%s", run_dir, delim, qnum, time_stamp);
            break;
        case 0: /* power tests */
            if (qnum < 0) /* update functions */
                sprintf(file_name,
                    "%s%smps00uf%d.%02d.%s", run_dir, delim, abs(qnum), \
                    currentUpdatePair, time_stamp);
            else
                sprintf(file_name,
                    "%s%smpqry%02d.%s", run_dir, delim, qnum, time_stamp);
            break;

        default:
            /* if (qnum < 0) - replaced by berni 96/03/26 */
            if (g_struct->c_l_opt->update == 2 ||
                g_struct->c_l_opt->update == 5)
                sprintf(file_name, "%s%smts%02duf%d.%02d.%s", run_dir, delim, \
                    currentUpdatePair - updatePairStart + 1, abs(qnum),
                    currentUpdatePair, time_stamp);
            else
                sprintf(file_name, "%s%smts%dqry%02d.%s", run_dir, delim, \
                    g_struct->c_l_opt->intStreamNum, qnum, time_stamp);
            break;
    }

    if (g_struct->c_flags->eo_infile)
        if (g_struct->c_l_opt->update == 2 ||
            g_struct->c_l_opt->update == 5)
            sprintf(file_name,
                "%s%smtufinter.%s", run_dir, delim, time_stamp);
        else
            switch (g_struct->c_l_opt->intStreamNum) {
                case -1:
                    sprintf(file_name,
                        "%s%sqryqualinter.%s", run_dir, delim, time_stamp);
                    break;
                case 0:
                    /* sprintf(file_name,
                    "%s%smpinter.%s", run_dir, delim, time_stamp); */
                    if (g_struct->c_l_opt->update == 1)
                        sprintf(file_name,
                            "%s%smpqinter.%s", run_dir, delim, time_stamp);
                    else
                        sprintf(file_name,
                            "%s%smpufinter.%s", run_dir, delim, time_stamp);
                    break;
                default:
                    if (g_struct->c_l_opt->intStreamNum > 0)
                        sprintf(file_name,

```

```

        "%s%smts%dinter.%s",
        run_dir,delim,g_struct->c_l_opt-
>intStreamNum,time_stamp);
    else
        fprintf(stderr,"Invalid stream number specified\n");
    break;
}

strcpy(outstreamfilename, file_name); /* wlc 081397 */

if (!feof(instream) || g_struct->c_flags->eo_infile)
    /* Only create an output file if there are input
    statements left to process, or if we're all done
    and want to print out the summary table file */
    if( (outstream = fopen(file_name, WRITEMODE)) == NULL ) {
        fprintf(stderr,"\n\nThe output file could not be opened. ");
        fprintf(stderr,"Make sure that the filename is correct.\n");
        fprintf(stderr,"filename = %s\n",file_name);
        exit(-1);
    }

return;
}

/*****
/* Determine whether or not we should break out of the block loop
because of an end of file, end of block, or update function.
Also handle some semaphore stuff for update functions */
/*****
int PreSQLprocess(struct global_struct *g_struct, Timer_struct
*start_time)
{
    int rc = 1;
    FILE *updateFP;
#ifdef SQLWINT
    int semid; /* semaphore for controlling UFs*/
    key_t semkey; /* key to generate semid */
#else
    int SemTimeout = 600000; /* Des time out period of 1
minute */
#endif

    switch (g_struct->c_flags->select_status)
    {
    case TPCDBATCH_NONSQL:
        g_struct->s_info_stop_ptr = g_struct->s_info_ptr;
        /* if we're at the end of the input file, set the stop
        pointer to this structure */
        rc = FALSE;
        break;
    case TPCDBATCH_EOBLOCK:
        rc = FALSE;
        break;
    case TPCDBATCH_INSERT:
        /* we have to check whether or not this is a throughput */
        /* test, and if it is, we have to set up a semaphore to */
        /* control when the update functions are run. We want */
        /* them to be run after all the query streams have finished. */
        /* What we do is set up the semaphore here, decrement it */
        /* in the query streams, and wait for it to get cleared */
        /* before we allow the UFs to run. */
        /* Note: we only set up the semaphore if: */
        /* 1. we are running the throughput test (num of */
        /* streams > 0) */
        /* 2. we are at the first UF1 (i.e. this is the */
        /* case where currentUpdatePair = updatePairStart */
        /* we also want to check the sem_on element in the global */
        /* structure to see if we want to use semaphores or let */
        /* the calling script do the synchronization of the update */

```

```

/* stream */
if ( semcontrol == 1 )
{
    /* yes we are to be using semaphores */
    /* is this the 1st time into update function 1 (uf1)? */
    if (currentUpdatePair == updatePairStart )
    {
        /* create the semaphores */
        create_semaphores(g_struct);
        if (g_struct->c_l_opt->intStreamNum != 0)
            /* wait period for runthroughput updates */
            throughput_wait(g_struct);
    }
    /* otherwise continue to run*/
}
if ((g_struct->c_l_opt->update == 3) || (g_struct->c_l_opt->update
== 4))
{
    get_start_time(start_time);
    strcpy(g_struct->s_info_ptr->start_stamp,
        get_time_stamp(T_STAMP_FORM_3,start_time )); /*
TIME_ACC jen*/
    /* write the start timestamp to the file...if this is not a qualification
*/
    /* run, then write the seed used as well */
    fprintf( outstream,"Start timestamp %*. *s \n",
        T_STAMP_3LEN,T_STAMP_3LEN, /*
TIME_ACC jen*/
        g_struct->s_info_ptr->start_stamp);
    if (g_struct->c_l_opt->intStreamNum >= 0)
    {
        if (g_struct->ISeed == -1)
        {
            fprintf( outstream,"Using default qgen seed file");
        }
        else
            fprintf( outstream,"Seed used = %ld",g_struct->ISeed);
        fprintf( outstream,"\n");
    }
}
if (g_struct->c_l_opt->update < 4){
    /* run only if updates are enabled */
    runUF1(g_struct, currentUpdatePair);
}

rc = FALSE;
if ((g_struct->c_l_opt->intStreamNum == 0) && (semcontrol == 1))
    /* RUNPOWER: release first semaphore so the queries can run */
    release_semaphore(g_struct, INSERT_POWER_SEM);
break;
case TPCDBATCH_DELETE:
    if ((g_struct->c_l_opt->intStreamNum == 0) && (semcontrol == 1))
    {
        /* RUNPOWER: wait for queries to finish */
        /* waiting on QUERY_POWER_SEM semaphore */
        runpower_wait(g_struct, QUERY_POWER_SEM);
    }
    if ((g_struct->c_l_opt->update == 3) || (g_struct->c_l_opt->update
== 4))
    {
        get_start_time(start_time);
        strcpy(g_struct->s_info_ptr->start_stamp,
            get_time_stamp(T_STAMP_FORM_3,start_time )); /*
TIME_ACC jen*/
        /* write the start timestamp to the file...if this is not a qualification
*/
        /* run, then write the seed used as well */
        fprintf( outstream,"Start timestamp %*. *s \n",
            T_STAMP_3LEN,T_STAMP_3LEN, /*
TIME_ACC jen*/

```

```

        g_struct->s_info_ptr->start_stamp);
if (g_struct->c_l_opt->intStreamNum >= 0)
{
    if (g_struct->lSeed == -1)
    {
        fprintf( outstream,"Using default qgen seed file");
    }
    else
        fprintf( outstream,"Seed used = %ld",g_struct->lSeed);
    fprintf( outstream,"\n");
}
}
if (g_struct->c_l_opt->update < 4){
/* run only if updates are enabled */
runUF2(g_struct, currentUpdatePair);
if (g_struct->c_l_opt->intStreamNum == 0)
/* RUNPOWER */
    fprintf(stderr, "UF2 completed\n");
}
}
currentUpdatePair += 1;
/* update the update.pair.num file to reflect the successfully
completed */
/* update pair */
if (g_struct->c_l_opt->update < 4)
{ /*jen*/
#ifdef NO_INCREMENT
    /* don't update the pair, only for my testing - Haider */
    updateFP = fopen(g_struct->update_num_file,"w");
    fprintf(updateFP,"%d\n",currentUpdatePair);
    fclose(updateFP);
#endif
} /*jen*/
rc = FALSE;
break;

}
return(rc);
}

/*****
/* Handles actual processing of SQL statement.  Initializes the SQLDA
for returned rows, does PREPARE, DECLARE, and OPEN
statements and
executed multiple FETCHes as needed.  If not a SELECT statement,
goes into EXECUTE IMMEDIATE section */
/*****
void SQLprocess(struct global_struct *g_struct)
{
    int rc = 0;                /* 912RETRY */
    int rows_fetch = 0;
    long sqlcode = SQL_RC_E911; /* Temporary sqlcode to test
for deadlocks */

    int max_wait = 1;         /* Maximum number of retries
for deadlock scenario */

    int col_lengths[TPCDBATCH_MAX_COLS]; /* array containing
widths of
                                columns in returned set */
    struct stmt_info *s_info_ptr;

    s_info_ptr = g_struct->s_info_ptr;
/*****
/* grab storage for the SQLDA */
/*****
if ((sqlda=(struct sqlda *)malloc(SQLDASIZE(100))) == NULL)
    mem_error("allocating sqlda");

```

```

    sqlda->sqln = TPCDBATCH_MAX_COLS; /* @d30369
tjg */

/* Error-recovery code for errors resulting from multi-stream errors */

while (((sqlcode == SQL_RC_E911) ||
(sqlcode == SQL_RC_E912) ||
(sqlcode == SQL_RC_E901)) &&
(max_wait < MAXWAIT) &&
(rc==0) )
{
    sqlcode = 0; /* Re-initialize sqlcode to avoid infinite-loop */
if (g_struct->c_flags->select_status == TPCDBATCH_SELECT)
{
/* Enter this loop if SQL stmt is a SELECT */
EXEC SQL PREPARE STMT1 INTO :*sqlda FROM :stmt_str;

    sqlcode = error_check();
if (sqlcode < 0)
{
    fprintf(stderr,"nPrepare failed. Stopping this query.\n");
    rc = -1;
}
else /* print out the column headings for the answer set */
{
    print_headings(sqlda,col_lengths); /* @d22817 tjg */

    allocate_sqlda(sqlda); /* This is where we set storage for the
*/
                                /* SQLDA based on the column types in */
                                /* the answer set table. */

    EXEC SQL DECLARE DYNCUR CURSOR FOR STMT1;

    EXEC SQL OPEN DYNCUR;
    sqlcode = error_check();

    if (sqlcode < 0) /* we ran into an error of some kind KBS
98/09/28 */
    {
        max_wait ++;
        fprintf(stderr, "\nAn error has been detected on
open...Retrying...\n");
        SleepSome(10);
    }
    else
    {
/*****
/* Fetch appropriate number of rows and determine whether
or not to */
/* send them to file. */
/*****

        rows_fetch = 0;

        do
        {
            /* Keep fetching as long as we haven't finished reading
all the rows and we haven't gone past the limits set
in the control string */

            EXEC SQL FETCH DYNCUR USING DESCRIPTOR
:*sqlda;
if (sqlca.sqlcode == 100)
{
                sqlcode = sqlca.sqlcode;

```



```

    }
    else
    {
        sqlcode = error_check();
    }
    if (sqlcode == 0)
    {
        rows_fetch++;
        if ( (rows_fetch <= s_info_ptr->max_rows_out) ||
            (s_info_ptr->max_rows_out == -1) )
            echo_sqlda(sqlda,col_lengths);
    }
    else if (sqlcode < 0)
    {
        max_wait++;
        fprintf (stderr, "\nAn error has been detected on
fetch...Retrying...\n");
        SleepSome(10);
    }
    } while ( (sqlcode == 0) && \
        ( (s_info_ptr->max_rows_fetch == -1) || \
          (rows_fetch < s_info_ptr->max_rows_fetch) ) );
    } /* end of successful open */
} /* end of successful prepare */
} /* End of block for handling SELECT statements */

else
{
    /* SQL statement is not a SELECT */
    EXEC SQL EXECUTE IMMEDIATE :stmt_str;
    sqlcode = error_check();

    if (sqlcode < 0 && sqlcode != -1415 ) /* TMPkmw */
    {
        max_wait ++;
        fprintf (stderr, "\nAn error has been detected on execute
immediate...Retrying...\n");
        SleepSome(10);
    }
} /* end of block for handling NON-select statements */

if ( ( sqlcode >= 0 ) &&
    (g_struct->c_flags->select_status == TPCDBATCH_SELECT))
{
    /* we opened a cursor before */
    EXEC SQL CLOSE DYNCUR;
    sqlcode = error_check();

    if ((s_info_ptr->max_rows_fetch == -1) ||
        (rows_fetch < s_info_ptr->max_rows_fetch))
#ifdef SQLPTX
        fprintf (outstream, "\n\nNumber of rows retrieved is: %6d",
            rows_fetch);
    else
        fprintf (outstream, "\n\nNumber of rows retrieved is: %6d",
            s_info_ptr->max_rows_fetch);
#else
        fprintf (outstream, "\n\nNumber of rows retrieved is: %6d",
            rows_fetch);
    else
        fprintf (outstream, "\n\nNumber of rows retrieved is: %6d",
            s_info_ptr->max_rows_fetch);
#endif
} /* @d28763 tjg */

if (s_info_ptr->query_block == FALSE) /* if block is off don't loop */
    g_struct->c_flags->eo_block = TRUE;

} /* end of while loop to retry if needed */
} /* end of SQLprocess */

```

```

/******
/* performs some operations after a statement has been processed,
including doing a COMMIT if necessary, and calculating the
elapsed time. Also initializes a new stmt_info structure
for the next block of statements */
/******
int PostSQLprocess(struct global_struct *g_struct, Timer_struct
*start_time)
{
    struct stmt_info *s_info_ptr;
    Timer_struct end_t; /* end point for elapsed time */

#ifdef DEBUG
    fprintf (outstream, "In PostSQLprocess\n");
#endif

    s_info_ptr = g_struct->s_info_ptr;

    if (g_struct->c_flags->select_status == TPCDBATCH_NONSQL)
        return FALSE; /* get out if we've reached the end of input file */

    if (g_struct->c_l_opt->update > 1)
    {
        /* This is an update function stream. There is no need to COMMIT.
*/
        /* Each UF child will COMMIT its own transactions. */
        ;
    }
    else
    { /* For non-UF cases, COMMIT now. */
        if (g_struct->c_l_opt->a_commit) {
            EXEC SQL COMMIT WORK;
            error_check(); /* @d22275 tjg */
        }
    }

    fflush(outstream);

    s_info_ptr->elapse_time = get_elapsed_time(start_time);

    if (g_struct->c_flags->time_stamp == TRUE) /* @d25594 tjg
*/
        get_start_time(&end_t); /* Get the end time */
        strcpy(s_info_ptr->end_stamp,
            get_time_stamp(T_STAMP_FORM_3,&end_t) );
        /*get_time_stamp(T_STAMP_FORM_3,(time_t)NULL);*/

    /* BBE: Pass on time stamp values for the next query */
    temp_time_struct = end_t;
    strcpy(temp_time_stamp, s_info_ptr->end_stamp);

    /* write the start timestamp to the file */
    fprintf( outstream, "\n\nStop timestamp %*.s \n",
        T_STAMP_3LEN, T_STAMP_3LEN, /* TIME_ACC jen*/
        s_info_ptr->end_stamp);

    /* DJD print elapsed time in seconds */
    fprintf (outstream, "Query Time = %15.1f secs\n", s_info_ptr-
>elapse_time);

    /* Allocate space for a new stmt_info structure */ /* @d24993 tjg
*/
    s_info_ptr->next =
        (struct stmt_info *) malloc(sizeof(struct stmt_info));
    if (s_info_ptr->next != NULL) {
        memset(s_info_ptr->next, '\0', sizeof(struct stmt_info));
        /* Transfer details from one structure to another for

```

```

    to apply for the next statement **/
    s_info_ptr->next->stmt_num = s_info_ptr->stmt_num + 1;
    s_info_ptr->next->max_rows_fetch = s_info_ptr->max_rows_fetch;
    s_info_ptr->next->max_rows_out = s_info_ptr->max_rows_out;

    s_info_ptr->next->query_block = s_info_ptr->query_block;
    s_info_ptr->next->elapsed_time = -1;

    s_info_ptr = s_info_ptr->next;
}
else {
    mem_error("allocating next stmt structure. Exiting\n");
    exit(-1);
}

/** Set the stop and travelling pointer to the current info structure **/
g_struct->s_info_stop_ptr = g_struct->s_info_ptr = s_info_ptr;

if (sqlda_allocated)
    free_sqlda(sqlda,g_struct->c_flags->select_status);
/* fix free() problem on NT
   wlc 090597 */

if (g_struct->c_l_opt->outfile != 0)
    fclose(outstream);

return (TRUE);
}

/*****
/* Does some cleaning up once all the statements are processed.
Disconnects
from the database, cleans up some semaphore stuff from the update
functions,
prints out the summary table, and closes all file handles. */
/*****
int cleanup(struct global_struct *g_struct)
{
#ifdef SQLWINT
    int      semid;      /* semaphore for controlling UFs*/
    key_t    semkey;     /* key to generate semid */
#endif
    char file_name[256] = "\0";

    /** End timestamp for stream **/
    /*g_struct->stream_end_time = time(NULL);*/
    get_start_time(&(g_struct->stream_end_time)); /* TIME_ACC jen */

    switch (g_struct->c_l_opt->update)
    {
        case (2):
        case (5):
            /* update throughput function stream */
            sprintf(file_name,"%s%sstrcntuf.%s",g_struct->run_dir,
                env_tpcd_path_delim, g_struct->file_time_stamp);
            break;
        case (3):
        case (4):
            /* update power function stream */
            sprintf(file_name,"%s%spsprcntuf.%s",g_struct->run_dir,
                env_tpcd_path_delim, g_struct->file_time_stamp);
            break;
        case (1):
            /* power query stream */
            sprintf(file_name, "%s%spsprcnt%d.%s",g_struct->run_dir,
                env_tpcd_path_delim,
                g_struct->c_l_opt->intStreamNum,g_struct-
                >file_time_stamp);
            break;

```

```

        case (0):
            /* throughput query stream */
            sprintf(file_name, "%s%sstrcnt%d.%s",g_struct->run_dir,
                env_tpcd_path_delim,
                g_struct->c_l_opt->intStreamNum,g_struct-
                >file_time_stamp);
            break;
    }
#endif LINUX

    if( (g_struct->stream_report_file = fopen(file_name, APPENDMODE))
        == NULL )
    {
        fprintf(stderr, "\nThe output file for the stream count information\n");
        fprintf(stderr, "could not be opened, make sure the filename is
        correct\n");
        fprintf(stderr, "filename = %s\n",file_name);
        exit(-1);
    }
#endif

    /* print out the stream stop time in the stream count information file*/
    if (g_struct->c_l_opt->update > 1)
    {
        /* update function stream */
        fprintf(g_struct->stream_report_file,
            "Update function stream stopping at %*.s\n",
            T_STAMP_3LEN,T_STAMP_3LEN, /* TIME_ACC jen*/
            get_time_stamp(T_STAMP_FORM_3,&(g_struct-
            >stream_end_time))); /* TIME_ACC jen*/
    }
    else
    {
        /* query stream(s) */
        fprintf(g_struct->stream_report_file,
            "Stream number %d stopping at %*.s\n",
            g_struct->c_l_opt->intStreamNum,
            T_STAMP_3LEN,T_STAMP_3LEN, /* TIME_ACC jen*/
            get_time_stamp(T_STAMP_FORM_3,&(g_struct-
            >stream_end_time))); /* TIME_ACC jen*/
    }
    fclose(g_struct->stream_report_file);

    /* No need to check for errors here.
    Also, the UF stream in a Throughput run
    has no connection in tpcdbatch.sqc.      aph 98/12/26
    error_check();
    */

    /* if we are in a query stream AND this is a throughput test, then
    need */
    /* do to some semaphore stuff (0 implies update functions are off) */
    /* AND we are supposed to be using semaphores */

    if ( ( semcontrol == 1 ) &&
        ( g_struct->c_l_opt->update < 2) )
        /* only queries need to release the semaphore at this point */
    {
        if (g_struct->c_l_opt->intStreamNum == 0)
            release_semaphore(g_struct, QUERY_POWER_SEM); /* power
            stream */
        else
            release_semaphore(g_struct, THROUGHPUT_SEM); /*
            throughput stream */
    }

    EXEC SQL CONNECT RESET;

```

```

#ifndef SQLWINT
    if (verbose)
    {
        fprintf(stderr,
            "cleanup: semkey = %ld, semid = %d, file = %s, stream =
%d\n",
            semkey,semid,g_struct->update_num_file,
            g_struct->c_l_opt->intStreamNum);
    }
#endif

/** Summary table processing **/                /* @d24993 tjj */
summary_table(g_struct);

fprintf (outstream, "\n\n");

fclose(outstream); /* Close the output data stream. */
fclose(instream); /* Close the SQL input stream. */

return (TRUE);
}

void create_semaphores(struct global_struct *g_struct)
{
#ifndef SQLWINT
    int      semid; /* semaphore for controlling UFs*/
    key_t    semkey; /* key to generate semid */
#else
    HANDLE    hSem;
    HANDLE    hSem2;
    int      SemTimeout = 600000; /* Des time out period of 1
minute */
#endif
    fprintf(stderr,"numstreams = %d\n",g_struct->c_l_opt-
>intStreamNum);
    fprintf(stderr,"Update stream creating semaphore(s) for update
and query sequencing\n");
#ifdef SQLWINT

    fprintf(stderr,"semfile = %s\n",g_struct->sem_file);
    if (g_struct->c_l_opt->intStreamNum == 0)
        /*RUNPOWER*/
        {
            fprintf(stderr,"semfile2 = %s\n",g_struct->sem_file2);
            hSem = CreateSemaphore(NULL, 0,1,(LPCTSTR)(g_struct-
>sem_file));
            hSem2 = CreateSemaphore(NULL, 0,1,(LPCTSTR)(g_struct-
>sem_file2));
            if ((hSem == NULL) || (hSem2 == NULL))
            {
                fprintf(stderr,
                    "CreateSemaphores (ready semaphore) failed,
GetLastError: %d, quitting\n",
                    GetLastError());
                exit(-1);
            }
            fprintf(stderr,"Semaphores created successfully!\n");
        }
    else
    {
        /* RUNTHROUGHPUT creates semaphores based on the number
of query streams while the number of streams for runpower is constant
*/
        hSem = CreateSemaphore(NULL, 0,
            g_struct->c_l_opt->intStreamNum,
            (LPCTSTR)(g_struct->sem_file));

```

```

        if (hSem == NULL)
        {
            fprintf(stderr,
                "CreateSemaphore (ready semaphore) failed,
GetLastError: %d, quitting\n",
                GetLastError());
            exit(-1);
        }
        fprintf(stderr,"Semaphore created successfully!\n");
    }
#else /* AIX, SUN, etc. */
    /* create a semaphore key...use the name of a file that */
    /* you know exists */
    fprintf(stderr,"semfile = %s\n", g_struct->update_num_file);
    semkey = ftok(g_struct->update_num_file,'J');
    if (g_struct->c_l_opt->intStreamNum == 0)
        /* RUNPOWER */
        {
            if ( ( semid =
semget(semkey,2,IPC_CREAT|S_IRUSR|S_IWUSR)) < 0)
            {
                fprintf(stderr,
                    "Throughput can't get initial semaphore! semget
failed errno = %d\n",
                    errno);
                exit(1);
            }
        }
    else
        /* THROUGHPUT */
        {
            if ( ( semid =
semget(semkey,1,IPC_CREAT|S_IRUSR|S_IWUSR)) < 0)
            {
                fprintf(stderr,
                    "Throughput can't get initial semaphore! semget
failed errno = %d\n",
                    errno);
                exit(1);
            }
            if (verbose)
            {
                fprintf(stderr,
                    "insert: semkey = %ld, semid = %d, file = %s,
value = %d\n",
                    semkey,semid,g_struct->update_num_file,
                    (g_struct->c_l_opt->intStreamNum * -1));
            }
        }
    }
#endif
}

/*throughput update */
void throughput_wait(struct global_struct *g_struct)
{
#ifndef SQLWINT
    int      semid; /* semaphore for controlling UFs*/
    key_t    semkey; /* key to generate semid */
#else
    HANDLE    hSem;
    int      j;
    int      SemTimeout = 600000; /* Des time out period of 1
minute */
#endif

```

```

#ifdef SQLWINT
    hSem = open_semaphore(g_struct, THROUGHPUT_SEM);
    for (j = 0; j < g_struct->c_l_opt->intStreamNum; j++)
    {
        if (verbose)
            fprintf(stderr, "About to wait again ...\\n");
        if (WaitForSingleObject(hSem, INFINITE) == WAIT_FAILED)
        {
            fprintf(stderr,
                "WaitForSingleObject (hSem) failed on stream %d,
error: %d, quitting\\n",
                j, GetLastError());
            exit(-1);
        }
        if (verbose)
            fprintf(stderr, "Streams to wait for %d\\n", j);
    }
    fprintf(stderr, "finished waiting on stream semaphore! Ready to run
updates\\n");
    /* close the semaphore handle */
    if (! CloseHandle(hSem)) {
        fprintf(stderr, "Close Sem failed - Last Error: %d\\n",
GetLastError());
        /* no exit here */
    }
#else
    semid = open_semaphore(g_struct);
    /* call the sem_op routine to decrement the semaphore by */
    /* however many streams .... by calling this function with*/
    /* a negative number, this stream is forced to wait until */
    /* the semaphore gets back to 0 */
    if (sem_op(semid, 0, (g_struct->c_l_opt->intStreamNum * -1)) !=
0)
    {
        /*jenSEM*/
        fprintf(stderr,
            "Failure to wait on throughput semaphone for %d
streams\\n",
            g_struct->c_l_opt->intStreamNum);
        exit(1);
    }
    /*jenSEM*/
    fprintf(stderr, "finished waiting on stream semaphore! Ready to run
updates\\n");
    semctl(semid, 0, IPC_RMID, 0); /* we've finished waiting, now */
    /* remove the semaphore */
#endif

void runpower_wait(struct global_struct *g_struct, int sem_num)
{
    char semfile[150];
#ifdef SQLWINT
    HANDLE hSem;

    if (sem_num == 1)
        strcpy (semfile, g_struct->sem_file);
    else
        strcpy (semfile, g_struct->sem_file2);

#else /* AIX */
    int    semid;        /* semaphore for controlling UFs*/
    key_t  semkey;      /* key to generate semid */

    strcpy (semfile, g_struct->update_num_file);
#endif

    if (g_struct->c_l_opt->update == 1)

```

```

        fprintf(stderr, "querystream waiting for update stream (UF1) to signal
semaphore based on %s\\n", semfile);
    else
        fprintf(stderr, "updatestream (UF2) waiting on querystream
semaphore to signal semaphore based on %s\\n", semfile);

#ifdef SQLWINT

    hSem = open_semaphore(g_struct, sem_num);
    if (verbose)
        fprintf(stderr, "Runpower queries about to wait ...\\n");
    if (WaitForSingleObject(hSem, INFINITE) == WAIT_FAILED)
    {
        fprintf(stderr,
            "WaitForSingleObject (hSem) failed on stream 0, error: %d,
quitting\\n",
            GetLastError());
        exit(-1);
    }
    if (! CloseHandle(hSem))
    {
        fprintf(stderr, "Close Sem failed - Last Error: %d\\n",
GetLastError());
        /* no exit here */
    }
#else

    semid = open_semaphore(g_struct);

    /* call the sem_op routine to decrement the semaphore by */
    /* however many streams .... by calling this function with*/
    /* a negative number, this stream is forced to wait until */
    /* the semaphore gets back to 0 */
    /* aix semaphores start at 0, not 1, so sem_num -1 is used */
    if (sem_op(semid, sem_num - 1, -1) != 0)
    {
        /*jenSEM*/
        fprintf(stderr,
            "Failure to wait on runpower semaphone for %d streams\\n",
            g_struct->c_l_opt->intStreamNum);
        exit(1);
    }
    /*jenSEM*/
#endif

    if (g_struct->c_l_opt->update == 1)
        fprintf(stderr, "querystream finished waiting on updatestream
semaphore\\n");
    else
        fprintf(stderr, "updatestream finished waiting on querystream
semaphore\\n");
}

void release_semaphore(struct global_struct *g_struct, int sem_num)
{
#ifdef SQLWINT
    int    semid;        /* semaphore for controlling UFs*/
    key_t  semkey;      /* key to generate semid */
#else
    HANDLE hSem;
    int    SemTimeout = 600000; /* Des time out period of 1
minute */
#endif

#ifdef SQLWINT
    hSem = open_semaphore(g_struct, sem_num); /* query */
    if (! ReleaseSemaphore(hSem,
        1,
        (LPLONG)(NULL)))
    {
        fprintf(stderr, "ReleaseSemaphore failed, Sem#: %d LastError:
%d, quit\\n",

```

```

        sem_num, GetLastError());
        exit(-1);
    }
#else
    semid = open_semaphore(g_struct); /* query */
    /* aix semaphores start at 0, not 1, so sem_num - 1 is used */
    if (sem_op(semid, sem_num - 1, 1) != 0)
/*jenSEM*/
    {
        /*jenSEM*/
        fprintf(stderr,
            "Failed to increment semaphore %d for throughput
stream %d\n",
            sem_num, g_struct->c_l_opt->intStreamNum);
        fprintf(stderr,
            "file for generation of semaphore is: %s\n",
            g_struct->update_num_file);
        exit(1);
    }
#endif
if (g_struct->c_l_opt->intStreamNum == 0)
{ /* RUNPOWER */
    if (sem_num == 1)
    {
        fprintf(stderr, "UF1 completed.\n");
    }
    else
    {
        fprintf(stderr, "query stream completed.\n");
    }
}
}

#ifdef SQLWINT /* Compile only in NT */
HANDLE open_semaphore(struct global_struct *g_struct, int num)
{
    HANDLE hSem;
    LPCTSTR semfile;

    if (num == 1)
        semfile = (LPCTSTR)g_struct->sem_file;
    else
        semfile = (LPCTSTR)g_struct->sem_file2;

    while ((hSem = OpenSemaphore(SEMAPHORE_ALL_ACCESS |
        SEMAPHORE_MODIFY_STATE |
        SYNCHRONIZE,
        TRUE,
        semfile))
        == (HANDLE)(NULL))
    {
        /*
        ** if cannot open the semaphore, wait for 0.1 second
        */
        fprintf(stderr, "Retry Open semaphore %s\n", semfile);

        Sleep(1000);
    }
    return hSem;
}

#else /* Compile only in non-NT (i.e. AIX) */
int open_semaphore(struct global_struct *g_struct)
{
    int semid; /* semaphore for controlling UFs*/
    key_t semkey; /* key to generate semid */
    int num;

    if (g_struct->c_l_opt->intStreamNum == 0)
        num = 2;

```

```

    else
        num = 1;

    semkey = ftok(g_struct->update_num_file, 'J');
    while ((semid = semget(semkey, num, 0)) < 0)
    {
        if (errno == ENOENT)
        {
            sleep(2);
            fprintf(stderr, "cleanUp: looping for access to semaphore
stream %d ",
                g_struct->c_l_opt->intStreamNum);
            fprintf(stderr, "semkey=%ld semid = %d
file=%s\n", semkey, semid,
                g_struct->update_num_file);
        }
        else
        {
            fprintf(stderr, "query stream %d semget failed errno =
%d\n",
                g_struct->c_l_opt->intStreamNum, errno);
            exit(1);
        }
    }
    return semid;
}
#endif

```

D.3 tpcdUF.sqc

```

#define UF1DEBUG
#define UF2DEBUG

#if (defined(SQLPTX) && defined(SQLSUN))
#define exit(rc) _exit(rc)
#else
#define exit(rc) exit(rc)
#endif /* SQLPTX & SQLSUN*/

#include "tpcdbatch.h"
/** EXEC SQL INCLUDE SQLCA; **/

#include "sqlca.h"
extern struct sqlca sqlca;

/*****
/* Function Prototypes */
/*****
extern int SleepSome( int amount );
extern long error_check(void); /* @d28763 tjg */
extern void dumpCa(struct sqlca*); /*kmw*/
extern int sem_op (int semid, int semnum, int value);
extern char *get_time_stamp(int form, Timer_struct *timer_pointer);
/* TIME_ACC jen */

/*****
/* Declare the SQL host variables. */
/*****
EXEC SQL BEGIN DECLARE SECTION;
char UF_dbname[9] = "\0";
char UF_userid[9] = "\0";
char UF_passwd[9] = "\0";
sqlint32 UF_chunk = 0;
short month = 0;
EXEC SQL END DECLARE SECTION;

/*****
/* Declare the global variables. */

```

```

/*****/
extern char env_tpcd_tmp_dir[150];
extern FILE *instream, *outstream; /* File pointers */
extern char sourcefile[256]; /* Used for semaphores and table
functions?*/
extern struct {
    short len;
    char data[32700];
} stmt_str; /* jen LONG */

/*****/
/* UF1 child */
/* (i is the application number.) */
/*****/
void runUF1_fn ( int updatePair, int i, char *dbname, char *userid, char
*passwd )
{
    int rc = 0;
    int split_updates = 2; /* no. of ways update records are split */
    int concurrent_inserts = 2; /* jenCI no of concurrent updates to be */
    /* jenCI run at once*/
    int loop_updates = 1; /* jenCI no of updates to be run in one */
    /* jenCI "concurrent" invocation. should*/
    /* jenCI be split_updates / concurrent_inserts*/
    int startChunk = 0; /* jenCI number of first chunk to insert for */
    /* jenCI this child */
    int stopChunk = 0; /* jenCI number of last chunk to insert for */
    /* jenCI this child */
    long insertedLineitem = 0; /*kmw*/
    long insertedOrders = 0; /*kmw*/
    long savedInsertedOrders = 0; /*kbs*/

    long sqlcode;
    int maxwait;

#ifdef SQLWINT
    int su_sem;
    key_t su_semkey;
#else
    HANDLE su_hSem;
    char UF1_semfile[256];
#endif

    char myoutstreamfile[256];
    FILE *myoutstream;

    strcpy(UF1_dbname, dbname);
    strcpy(UF1_userid, userid);
    strcpy(UF1_passwd, passwd);

    /* Get ready to start logging diagnostic output */
    sprintf(myoutstreamfile, UF1OUTSTREAMPATTERN,
env_tpcd_tmp_dir, PATH_DELIM,
updatePair, i);
    if ( (myoutstream = fopen(myoutstreamfile, WRITEMODE)) ==
NULL)
    {
        fprintf(stderr, "\nThe output file '%s' for update pair %d set %d
could not be opened. runUF1_fn\n",
myoutstreamfile, updatePair, i);
        rc=-1;
        goto UF1_exit;
    }
    outstream=myoutstream; /* initialize outstream for error_check
dxxxxhar*/

    fprintf(myoutstream, "\nUF1 for update pair %d set %d starting at
%.*s\n",
updatePair, i,

```

```

T_STAMP_1LEN, T_STAMP_1LEN, /* TIME_ACC jen*/
get_time_stamp(T_STAMP_FORM_1, (Timer_struct *)NULL));
/* TIME_ACC jen*/

if (getenv("TPCD_SPLIT_UPDATES") != NULL)
    split_updates = atoi(getenv("TPCD_SPLIT_UPDATES"));
if (getenv("TPCD_CONCURRENT_INSERTS") != NULL)
/*jenCI*/
    concurrent_inserts = atoi(getenv
("TPCD_CONCURRENT_INSERTS")); /*jenCI*/
    loop_updates = split_updates / concurrent_inserts;
/*jenCI*/

/* determine the starting and stopping point of the chunks that this
jenCI*/
/* invocation will apply. i is starting chunk number with range 0
jenCI*/
/* through (concurrent_inserts -1) jenCI*/
    startChunk = i * loop_updates; /*jenCI*/
    stopChunk = startChunk + (loop_updates - 1);
/*jenCI*/

/* Establish a connection to the database */
if (!strcmp(userid, "0")) /* No authentication provided */
    EXEC SQL CONNECT TO :UF_dbname;
else
    EXEC SQL CONNECT TO :UF_dbname USER :UF_userid USING
:UF_passwd;
error_check();
if (sqlca.sqlcode < 0)
{
    rc=-1;
    goto UF1_exit;
}

/* Start processing each chunk in my range */
#ifdef UF1DEBUG
    fprintf(myoutstream, "Before loop_a startChunk = %d, stopChunk =
%d\n", startChunk, stopChunk);
    fflush(myoutstream);
#endif
for ( UF_chunk = startChunk; UF_chunk <= stopChunk; UF_chunk++)
/*jenCI*/
{
    /* wlc 062797 */
    sqlcode = SQL_RC_E911;
    month = (short)UF_chunk; /* Cast 'short' added bbe */
    maxwait = 1;
    rc = 0;

#ifdef UF1DEBUG
    fprintf(myoutstream, "Before While_a Chunk= %d\n", UF_chunk);
    fflush(myoutstream);
#endif
/* Loop to handle any deadlocks */
while (sqlcode == SQL_RC_E911 && maxwait <= MAXWAIT &&
rc==0)
{
    sqlcode = 0;
#ifdef UF1DEBUG
    fprintf(myoutstream, "in loop before orders exec sql\n");
    fflush(myoutstream);
#endif
EXEC SQL INSERT INTO TPCD.ORDERS
SELECT
O_ORDERKEY, O_CUSTKEY, O_ORDERSTATUS, O_TOTALPRICE,

```

```

O_ORDERDATE,O_ORDERPRIORITY,O_CLERK,O_SHIPRIORITY,
O_COMMENT
    FROM TPCDTEMP.ORDERS_NEW
    WHERE APP_ID = :UF_chunk;
    /*AND 12*(YEAR(O_ORDERDATE)-
1992)+MONTH(O_ORDERDATE)-01 = :month;*/

    if (sqlca.sqlcode < 0)
        sqlcode = error_check();

    if (sqlcode == SQL_RC_E911)
    {
        /* we've hit a deadlock */
        fprintf (myostream,
            "\nDeadlock detected inserting from tpcdtemp.orders_new
for chunk %d for pair %d..Retrying...\n",UF_chunk,updatePair);
        SleepSome(UF_DEADLOCK_SLEEP);
        maxwait++;
        /* jen DEADLOCK */
    }
    else if (sqlcode < 0)
    {
        fprintf(myostream,
            "Insert into orders pair %d chunk %d failed
sqlcode=%d\n",
            updatePair,UF_chunk,sqlcode);
        dumpCa(&sqlca);
        rc = -1;
    }
    else
    {
        /* Everything worked with ORDERS, proceed with LINEITEM */
        saveInsertedOrders = sqlca.sqlerrd[2];

        sqlcode = 0;
#ifdef UF1DEBUG
        fprintf (myostream, "in lineitem for update pair number %d set
%d chunk %d\n",
            updatePair, i,UF_chunk);
        fflush(myostream);
#endif

        EXEC SQL INSERT INTO TPCD.LINEITEM
        SELECT
        L_ORDERKEY,L_PARTKEY,L_SUPPKEY,L_LINENUMBER,L_QUAN
TITY,
        L_EXTENDEDPRI, L_DISCOUNT,L_TAX,
        L_RETURNFLAG,L_LINESTATUS,L_SHIPDATE,L_COMMITDATE,L_
RECEIPTDATE,
        L_SHIPINSTRUCT,L_SHIPMODE,L_COMMENT
        FROM TPCDTEMP.LINEITEM_NEW WHERE APP_ID =
:UF_chunk;
        /*(AND L_ORDERKEY IN
        (SELECT O_ORDERKEY FROM TPCD.ORDERS
        WHERE 12*(YEAR(O_ORDERDATE)-
1992)+MONTH(O_ORDERDATE)-01 = :month);*/

        if (sqlca.sqlcode < 0)
            sqlcode = error_check();

        if (sqlcode == SQL_RC_E911)
        {
            /* we've hit a deadlock */
            fprintf (myostream,
                "\nA deadlock has been detected inserting from
tpcdtemp.lineitem%d_%d..Retrying...\n",
                updatePair, UF_chunk);
            SleepSome(UF_DEADLOCK_SLEEP);
            maxwait++;
            /* jen DEADLOCK */
        }
        else if (sqlcode < 0)

```

```

    {
        fprintf(myostream,
            "Insert into lineitem pair %d chunk %d failed
sqlcode=%d\n",
            updatePair,UF_chunk,sqlcode);
        dumpCa(&sqlca);
        rc = -1;
    }
    else
    {
#ifdef UF1DEBUG
        fprintf (myostream, "lineitem insert succeeded\n");
        fflush(myostream);
#endif

        /* accumulate the number of row inserted */
        /* Order count ONLY updated if both orders and lineitem */
        /* go through */
        insertedOrders += saveInsertedOrders;
        /* kbs */
        insertedLineitem += sqlca.sqlerrd[2];
        rc=0;
        EXEC SQL COMMIT WORK;
        error_check();

#ifdef UF1DEBUG
        /* report the number of row inserted */
        fprintf(myostream, " interim %ld rows for chunk %d into
TPCD.ORDERS at %*. *s\n",

insertedOrders,UF_chunk,T_STAMP_1LEN,T_STAMP_1LEN, /*
TIME_ACC jen*/
            get_time_stamp(T_STAMP_FORM_1,(Timer_struct
*)NULL)); /* TIME_ACC jen*/
        /* report the number of row deleted *s inserted */
        fprintf(myostream,
            " interim %ld rows for chunk %d into TPCD.LINEITEM
at %*. *s\n",

            insertedLineitem,UF_chunk,
            T_STAMP_1LEN,T_STAMP_1LEN, /* TIME_ACC jen*/
            get_time_stamp(T_STAMP_FORM_1,
                (Timer_struct *)NULL)); /* TIME_ACC jen*/

        fprintf( myostream,
            " inserts for update pair %d chunk %d complete at
%*. *s\n\n",

            updatePair, UF_chunk,
            T_STAMP_1LEN,T_STAMP_1LEN, /* TIME_ACC jen*/
            get_time_stamp(T_STAMP_FORM_1,
                (Timer_struct *)NULL)); /* TIME_ACC jen*/

#endif
    }
} /* process lineitem INSERTs */
} /* while loop for deadlocks */
} /* while processing chunks */

/* report the number of row deleted */
fprintf(myostream, "%ld rows inserted into TPCD.ORDERS at
%*. *s\n",
    insertedOrders,T_STAMP_1LEN,T_STAMP_1LEN, /*
TIME_ACC jen*/
    get_time_stamp(T_STAMP_FORM_1,(Timer_struct *)NULL));
/* TIME_ACC jen*/
fprintf(myostream, "%ld rows inserted into TPCD.LINEITEM at
%*. *s\n",
    insertedLineitem,T_STAMP_1LEN,T_STAMP_1LEN, /*
TIME_ACC jen*/
    get_time_stamp(T_STAMP_FORM_1,(Timer_struct *)NULL));
/* TIME_ACC jen*/

    if (sqlcode < 0)

```

```

{
  if (sqlcode == SQL_RC_E911)
  {
    fprintf (myostream,"# of deadlocks exceeds %i\n", MAXWAIT);
  }
  rc=-1;
  EXEC SQL ROLLBACK WORK;
  error_check();          /* @d22275 tjg */

  goto UF1_exit;
}

/* UF1_conn_reset: */
EXEC SQL CONNECT RESET;
error_check();          /* @d22275 tjg */

UF1_exit:
fclose (myostream);
/* exiting, increment the semaphore */

/* we used the first flat file to generate the semaphore key */

#ifndef SQLWINT
/* we will use the tpcd.setup file to generate the semaphore key
begin SEMA */
if (getenv("TPCD_AUDIT_DIR") != NULL)
{
  /* this is assuming that you will be running this from 0th node */
  sprintf(sourcefile, "%s%ctools%ctpcd.setup",
    getenv("TPCD_AUDIT_DIR"), PATH_DELIM,PATH_DELIM);
}
else
{
  fprintf (stderr, "Can't open UF1 semaphore file TPCD_AUDIT_DIR
is not defined.\n");
  exit (-1);
}
/* end SEMA */

su_semkey = ftok (sourcefile, 'J');
while ( (su_semid = semget (su_semkey, 1, 0)) < 0)
{
  if (errno == ENOENT) {
    sleep(2);
  }
  else {
    fprintf(stderr,"update set %d: semget failed errno = %d\n",
      i, errno);
    exit(1);
  }
}
if (sem_op (su_semid, 0, 1) != 0)          /*jen SEM*/
{
  fprintf(stderr,"Failure to increment semaphore UF1 set %d\n",i);
  fprintf(stderr," semaphore sourcefile = %s su_semid =
su_semid\n",sourcefile);
  exit(1);
}
/*jenSEM*/

#else /* SQLWINT */
printf (UF1_semaphore, "%s.%s.UF1.semfile",
  getenv("TPCD_DBNAME"), getenv("USER"));
fprintf(stderr,"UF1 semaphore = %s\n",UF1_semaphore);
while ((su_hSem = OpenSemaphore(SEMAPHORE_ALL_ACCESS |
  SEMAPHORE_MODIFY_STATE |
  SYNCHRONIZE,
  TRUE,
  UF1_semaphore))
  == (HANDLE)(NULL))

```

```

{
  /*
  ** if cannot open the semaphore, wait for 0.1 second
  */
  fprintf(stderr,"Retry Open semaphore %s\n", UF1_semaphore);

  sleep(1);
}

if (! ReleaseSemaphore(su_hSem,
  1,
  (LPLONG)(NULL)))
{
  fprintf(stderr, "ReleaseSemaphore failed, LastError: %d, quit\n",
    GetLastError());
  exit(-1);
}
#endif /* SQLWINT */
exit(rc);          /* child exiting after finishing up */
}

/*****
/* UF2 child */
*****/
void runUF2_fn ( int updatePair, int thisConcurrentDelete, int
numChunks, char *dbname, char *userid, char *passwd )
{
  int rc = 0;
  long sqlcode;
  int maxwait;
  int startChunk = thisConcurrentDelete*numChunks; /* where do we
start? */
  long deletedLineitems = 0; /*kmw*/
  long deletedOrders = 0; /*kmw*/
  long savedDeletedLineitems = 0; /*kbs*/

#ifndef SQLWINT
  int su_semid; /* semaphore for controlling split updates*/
  key_t su_semkey; /* key to generate semid */
#else
  HANDLE su_hSem;
  char UF2_semaphore[256];
#endif

  char myostreamfile[256];
  FILE *myostream, *src_fh=NULL;

  strcpy(UF_dbname, dbname);
  strcpy(UF_userid, userid);
  strcpy(UF_passwd, passwd);

  /* Generate the unique filename for this concurrent delete process */
  sprintf (myostreamfile, UF2OUTSTREAMPATTERN,
env_tpcd_tmp_dir, PATH_DELIM,
  updatePair, thisConcurrentDelete);
  if ( (myostream = fopen (myostreamfile, WRITEMODE)) ==
NULL)
  {
    fprintf (stderr,
      "\nThe output file '%s' for update pair %d set %d could not be
opened runUF2_fn.\n",
      myostreamfile,updatePair,thisConcurrentDelete);
    rc=-1;
    goto UF2_exit;
  }
}

```



```

    ostream=myostream; /* initialize ostream for error_check
dxxxxhar*/

#ifdef UF2DEBUG
    fprintf (myostream, "RunUF2 Called %d %d %d\n",
            updatePair, thisConcurrentDelete, numChunks );
    fflush(myostream);
#endif
    fprintf( myostream,
            "\nUF2 for update pair %d set %d starting at %*.s\n",
            updatePair, thisConcurrentDelete,
T_STAMP_1LEN,T_STAMP_1LEN, /* TIME_ACC jen*/
            get_time_stamp(T_STAMP_FORM_1,(Timer_struct *)NULL));
/* TIME_ACC jen*/

#ifdef UF2DEBUG
    fprintf (myostream, "before connect\n");
    fflush(myostream);
#endif

    if (!strcmp(userid,"0")) /** No authentication provided **/
        EXEC SQL CONNECT TO :UF_dbname;
    else
        EXEC SQL CONNECT TO :UF_dbname USER :UF_userid USING
:UF_passwd;
    error_check();

#ifdef UF2DEBUG
    fprintf (myostream, "after connect startchunk= %d, EndChunk =
%d\n",
            startChunk, startChunk+numChunks);
    fflush(myostream);
#endif

    /* Start processing each chunk in my range */
    for ( UF_chunk = startChunk; UF_chunk < startChunk+numChunks;
UF_chunk++ )
    {

        /* Set things up for the loop which will retry if there is a deadlock */
        sqlcode = SQL_RC_E911;
        month = (short)UF_chunk;
        maxwait = 1;
        rc = 0;

#ifdef UF2DEBUG
        fprintf (myostream, "Chunk = %d\n", UF_chunk);
        fflush(myostream);
#endif
        while (sqlcode == SQL_RC_E911 && maxwait <= MAXWAIT && rc
== 0)
        {

#ifdef UF2DEBUG
            fprintf (myostream, "in loop before orders exec sql\n");
            fflush(myostream);
#endif
            sqlcode = 0;

            EXEC SQL DELETE FROM TPCD.LINEITEM
                WHERE L_ORDERKEY IN
                (SELECT O_ORDERKEY FROM
TPCDTEMP.ORDERS_DEL
                WHERE APP_ID = :UF_chunk);
            /*AND O_ORDERKEY IN
                (SELECT O_ORDERKEY FROM TPCD.ORDERS
                WHERE 12*(YEAR(O_ORDERDATE)-
1992)+MONTH(O_ORDERDATE)-01 = :month);*/
            if (sqlca.sqlcode < 0)
                sqlcode = error_check();

```

```

        if (sqlcode == SQL_RC_E911)
        {
            /* we've hit a deadlock */
            fprintf (myostream,
                    "\nA deadlock detected while deleting from LINEITEM: update
pair %d set %d chunk %d. Retrying.\n",
                    updatePair, thisConcurrentDelete, UF_chunk);
            dumpCa(&sqlca);
            SleepSome(UF_DEADLOCK_SLEEP);
            maxwait++; /* jen DEADLOCK */
        }
        else if (sqlcode < 0)
        {
            fprintf (myostream, "\n%s\n", stmt_str.data);
            fprintf (myostream, "\nsqlcode %d occurred deleting from
TPCD.LINEITEM\n", sqlca.sqlcode);
            dumpCa(&sqlca);
            fprintf (myostream,
                    "for update pair number %d set %d chunk %d..Exiting\n",
                    updatePair, thisConcurrentDelete,UF_chunk);
            rc=-1;
        }
        else
        {
            /* accumulate the number of row deleted */
            savedDeletedLineitems = sqlca.sqlerrd[2]; /*kbs*/

```

```

#ifdef UF2DEBUG
        fprintf (myostream, "in loop for update pair number %d set %d
chunk %d\n",
                updatePair, thisConcurrentDelete,UF_chunk);
        fflush(myostream);
#endif

        /* delete the orders now */

        EXEC SQL DELETE FROM TPCD.ORDERS
        WHERE O_ORDERKEY IN
        (SELECT O_ORDERKEY FROM TPCDTEMP.ORDERS_DEL
        WHERE APP_ID = :UF_chunk);
        /*AND 12*(YEAR(O_ORDERDATE)-
1992)+MONTH(O_ORDERDATE)-01 = :month;*/

        if (sqlca.sqlcode < 0)
            sqlcode = error_check();

        if (sqlcode == SQL_RC_E911)
        {
            /* we've hit a deadlock */

```

```

#ifdef UF2DEBUG
            fprintf (myostream, "orders deadlocked\n");
            fflush(myostream);
#endif
            fprintf (myostream,
                    "\nA deadlock detected while deleting from ORDERS: update
pair %d set %d chunk %d. Retrying.\n",
                    updatePair, thisConcurrentDelete, UF_chunk);
            dumpCa(&sqlca);
            SleepSome(UF_DEADLOCK_SLEEP);
            maxwait++; /* jen DEADLOCK */
        }
        else if (sqlcode < 0)
        {

```

```

#ifdef UF2DEBUG
            fprintf (myostream, "orders failed\n");
            fflush(myostream);
#endif
            fprintf (myostream, "\nAn error %d occurred deleting from
TPCD.ORDERS\n",sqlca.sqlcode);
            dumpCa(&sqlca);

```

```

        fprintf (myostream,"for update pair number %d set %d
chunk %d..Exiting\n",
        updatePair, thisConcurrentDelete,UF_chunk);
        rc=-1;
    }
    else
    {
#ifdef UF2DEBUG
        fprintf (myostream, "orders succeeded\n");
        fflush(myostream);
#endif
        /* accumulate the number of row deleted */
        /* Order count ONLY updated if both orders and lineitem */
        /* go through */
        deletedLineitems += savedDeletedLineitems; /* kbs */
        deletedOrders += sqlca.sqlerrd[2];
        rc=0;
        EXEC SQL COMMIT WORK;
        error_check();
#ifdef UF2DEBUG
        /* report the number of rows deleted */
        fprintf(myostream, " interim %ld rows for chunk %d from
TPCD.ORDERS at %*.s\n",

deletedOrders,UF_chunk,T_STAMP_1LEN,T_STAMP_1LEN, /*
TIME_ACC jen*/
        get_time_stamp(T_STAMP_FORM_1,(Timer_struct
*)NULL)); /* TIME_ACC jen*/
        fprintf(myostream, " interim %ld rows for chunk %d from
TPCD.LINEITEM at %*.s\n",

deletedLineitems,UF_chunk,T_STAMP_1LEN,T_STAMP_1LEN, /*
TIME_ACC jen*/
        get_time_stamp(T_STAMP_FORM_1,(Timer_struct
*)NULL)); /* TIME_ACC jen*/
        fprintf( myostream,
            " deletes for update pair %d chunk %d complete at
%*.s\n\n",
            updatePair, UF_chunk,
            T_STAMP_1LEN,T_STAMP_1LEN, /* TIME_ACC jen*/
            get_time_stamp(T_STAMP_FORM_1,
            (Timer_struct *)NULL)); /* TIME_ACC jen*/
#endif
    }
} /* process orders deletes */
} /* while trying to delete one chunk loop */
} /* while there are more chunks */

#ifdef UF2DEBUG
    fprintf (myostream, "after loop\n");
    fflush(myostream);
#endif
/* report the number of row deleted */
fprintf(myostream, "%ld rows deleted from TPCD.ORDERS at
%*.s\n",
    deletedOrders,T_STAMP_1LEN,T_STAMP_1LEN, /*
TIME_ACC jen*/
    get_time_stamp(T_STAMP_FORM_1,(Timer_struct *)NULL));
/* TIME_ACC jen*/
fprintf(myostream, "%ld rows deleted from TPCD.LINEITEM at
%*.s\n",
    deletedLineitems,T_STAMP_1LEN,T_STAMP_1LEN, /*
TIME_ACC jen*/
    get_time_stamp(T_STAMP_FORM_1,(Timer_struct *)NULL));
/* TIME_ACC jen*/

    if (sqlca.sqlcode < 0)
    {
        fprintf (myostream, "# of deadlocks %d exceeds %i\n",
maxwait,MAXWAIT);
    }

```

```

        rc=-1;
        EXEC SQL ROLLBACK WORK;
        error_check(); /* @d22275 tjg */
    }

/* UF2_conn_reset: */ /*971101jen*/
EXEC SQL CONNECT RESET;
error_check(); /* @d22275 tjg */

UF2_exit:
    fclose (myostream);

    /* exiting, increment the semaphore */
#ifdef SQLWINT
    /* we used the tpcd.setup file to generate the semaphore key
begin SEMA */
    if (getenv("TPCD_AUDIT_DIR") != NULL)
    {
        sprintf(sourcefile, "%s%ctools%ctpcd.setup",
            getenv("TPCD_AUDIT_DIR"), PATH_DELIM, PATH_DELIM);
    }
    else
    {
        fprintf (stderr, "Can't open UF2 semaphore file TPCD_AUDIT_DIR
is not defined.\n");
        exit (-1);
    }

    su_semkey = ftok (sourcefile, 'D'); /* use D for deletes */
    /* end SEMA */
    while ((su_semid = semget(su_semkey,1,0)) < 0)
    {
        if (errno == ENOENT)
            sleep(2);
        else {
            fprintf(stderr,"UF2 update stream %d: semget failed errno =
%d\n",
                updatePair, errno);
            exit(1);
        }
    }
    if (sem_op (su_semid, 0, 1) != 0) /*jenSEM*/
    {
        /*jenSEM*/
        fprintf(stderr,"Failure to increment semaphone UF2 set %d\n",
thisConcurrentDelete);
        exit(1);
    }
    /*jenSEM*/

#else
    sprintf (UF2_semfile, "%s.%s.UF2.semfile",
        getenv("TPCD_DBNAME"), getenv("USER"));
    fprintf(stderr,"UF2 semfile = %s\n",UF2_semfile);
    while ((su_hSem = OpenSemaphore(SEMAPHORE_ALL_ACCESS |
        SEMAPHORE_MODIFY_STATE |
        SYNCHRONIZE,
        TRUE,
        UF2_semfile))
        == (HANDLE)(NULL)) {
        /*
        ** if cannot open the semaphore, wait for 0.1 second
        */
        fprintf(stderr,"Retry Open semaphore %s\n", UF2_semfile);

        SleepSome(1);
    }

    if (! ReleaseSemaphore(su_hSem,
        1,
        (LPLONG)(NULL)))

```

```

    {
        fprintf(stderr, "ReleaseSemaphore failed, LastError: %d, quit\n",
            GetLastError());
        exit(-1);
    }
#endif

    exit(rc);          /* child exiting after finishing up */
}

```

D.4 Makefile

```

#####
#####
# MAKEFILE for tpcdbatch program
# Enter the Following:
#
#   make tpcdbatch  -- makes tpcdbatch
#
#   make cleanup   -- removes builds from tpcdbatch program
#
#####
#####

DB=tpcd

BASE=$(HOME)/sqllib
##COMPILE_FLAGS=-c -DSQLAIX -I$(BASE)/include -g -
qmaxmem=-1 -q64
COMPILE_FLAGS=-c -DSQLAIX -I$(BASE)/include -O2 -qmaxmem=-
1 -q64
#COMPILE_FLAGS=-c -DSQLAIX -I$(BASE)/include -g
# if using an installed db2 image use the 2nd link_flags value
LINK_FLAGS=-o $@ -L$(BASE)/lib -ldb2 -q64 -lm
#LINK_FLAGS=-o $@ -L/usr/lpp/db2_05_00/lib -ldb2
COMPILER=xlc
LIB_LINKER=ld
LIB_LINK_FLAGS=-o $@ -H512 -T512 -bE:$@.exp -L$(BASE)/lib -
ldb2 -lc

cleanup :
    rm -f tpcdbatch tpcdbatch.bnd tpcdbatch.o tpcdbatch.c
    tpcdbatch.u tpcdUF.bnd tpcdUF.o tpcdUF.c tpcdUF.u 2>/dev/null

all : tpcdbatch

tpcdbatch.c : tpcdbatch.sqc
    @echo 'connect to $(DB) \n prep tpcdbatch.sqc BINDFILE
PACKAGE ISOLATION RR BLOCKING ALL OPTLEVEL 1 DATETIME
ISO \n connect reset \n terminate \n' | db2 -c +p -v +t

tpcdUF.c : tpcdUF.sqc
    @echo 'connect to $(DB) \n prep tpcdUF.sqc BINDFILE
PACKAGE ISOLATION RR BLOCKING ALL OPTLEVEL 1 DEGREE 1
DATETIME ISO \n connect reset \n terminate \n' | db2 -c +p -v +t

tpcdbatch : tpcdUF.c tpcdbatch.c
    $(COMPILER) $(COMPILE_FLAGS) tpcdUF.c
    $(COMPILER) $(COMPILE_FLAGS) tpcdbatch.c
    $(COMPILER) $(LINK_FLAGS) tpcdUF.o tpcdbatch.o

```

D.5 runpower

```

: # *-Perl*-
eval `exec perl -S $0 ${1+"$@"}` # Horrible kludge to convert this
    if 0;          # into a "portable" perl script

# usage runpower [UF]

```

```

# where UF is the optional parameter that says to run the power test
# with the update functions. By default, the update functions are not
# run

```

```

push(@INC, split(':', $ENV{'PATH'}));

```

```

# Get TPC-D specific environment variables
require 'getvars';

```

```

# Use the macros in here so that they can handle the platform
differences.
# macro.pl should be sourced from cmvc, other people wrote and
maintain it.
require "macro.pl";
require "tpcdmacro.pl";

```

```

# Make output unbuffered.
select(STDOUT);
$| = 1 ;

```

```

if (@ARGV > 0)

```

```

{
    $runUF=$ARGV[0];
}
else
{
    $runUF="no";
}

```

```

if (length($ENV{"TPCD_AUDIT_DIR"}) <= 0)
{
    die "TPCD_AUDIT_DIR environment variable not set\n";
}

```

```

if (length($ENV{"TPCD_RUN_DIR"}) <= 0)
{
    die "TPCD_RUN_DIR environment variable not set\n";
}

```

```

if (length($ENV{"TPCD_DBNAME"}) <= 0)
{
    die "TPCD_DBNAME environment variable not set\n";
}

```

```

if (length($ENV{"TPCD_RUNNUMBER"}) <= 0)
{
    die "TPCD_RUNNUMBER environment variable not set\n";
}

```

```

if (length($ENV{"TPCD_SF"}) <= 0)
{
    die "TPCD_SF environment variable not set\n";
}

```

```

if (length($ENV{"TPCD_PLATFORM"}) <= 0)
{
    die "TPCD_PLATFORM environment variable not set\n";
}

```

```

if (length($ENV{"TPCD_PATH_DELIM"}) <= 0)
{
    die "TPCD_PATH_DELIM environment variable not set\n";
}

```

```

if (length($ENV{"TPCD_PRODUCT"}) <= 0)
{
    die "TPCD_PRODUCT environment variable not set\n";
}

```

```

if (length($ENV{"TPCD_AUDIT"}) <= 0)
{
    die "Must set TPCD_AUDIT env't var. Real audit timing sequence
run if yes\n";
}

```

```

if (length($ENV{"TPCD_PHYS_NODE"}) <= 0)
{
    die "TPCD_PHYS_NODE env't var not set\n";
}

```

```

if (length($ENV{"TPCD_LOG_DIR"}) <= 0)
{
    $ENV{"TPCD_LOG_DIR"} = "NULL";
}
if (length($ENV{"TPCD_MODE"}) <= 0)
{
    die "TPCD_MODE environment variable not set - uni/smp/mln \n";
}
if (length($ENV{"TPCD_ROOTPRIV"}) <= 0)
{
    die "TPCD_ROOTPRIV environment variable not set - yes/no \n";
}

#set up local variables
$runNum=$ENV{"TPCD_RUNNUMBER"};
$runDir=$ENV{"TPCD_RUN_DIR"};
$auditDir=$ENV{"TPCD_AUDIT_DIR"};
$dbname=$ENV{"TPCD_DBNAME"};
$sf=$ENV{"TPCD_SF"};
$platform=$ENV{"TPCD_PLATFORM"};
$delim=$ENV{"TPCD_PATH_DELIM"};
$gatherstats=$ENV{"TPCD_GATHER_STATS"};
$product=$ENV{"TPCD_PRODUCT"};
$RealAudit=$ENV{"TPCD_AUDIT"};
$inlistmax=$ENV{"TPCD_INLISTMAX"};
$pn=$ENV{"TPCD_PHYS_NODE"};
$logDir=$ENV{"TPCD_LOG_DIR"};
$rootPriv=$ENV{"TPCD_ROOTPRIV"};
$mode=$ENV{"TPCD_MODE"};
if (( $mode eq "uni" ) || ( $mode eq "smp" ))
{
    $all_in="once";
    $all_pn="once";
    $once="once";
}
else
{
    $all_in="all_in";
    $all_pn="all_pn";
    $once="once";
}

if ($inlistmax eq "default")
{
    $inlistmax = 400;
}

# the auditruns directory is where we have already generate the sql
files for the
# updates and the power tests

# append isolation level information about tpcdbatch to the miso file
# the miso file is created here but appended to for power and
throughput
#information

$misofile="$runDir${delim}miso$runNum";
if ( -e $misofile )
{
    &rm("$misofile");
}
# if we are in real audit mode then we must start the db manager now
since
# there must be no activity on the database between the time the build
script
# has finished and the time the power test is started
if ( $RealAudit eq "yes" )
{
    system("db2start");

```

```

    system("db2 activate database $dbname");
}

open(MISO, ">$misofile") || die "Can't open $misofile: $\n";
$curTs = `perl gettimestamp "long"`;
print MISO "Timestamp and isolation level of tpcdbatch before power
run at : $curTs\n";
close(MISO);
if ( $product eq "pe" )
{
    system("db2 \"connect to $dbname\"; db2 \"select
name,creator,valid,unique_id,isolation from sysibm.sysplan where
name like 'TPCD%'\"; db2 connect reset; db2 terminate >>
$runDir${delim}miso$runNum ");
}
else
{
    &verifyTPCdbatch("$misofile", "$dbname");
}

if ($platform eq "aix")
{
    # Create the sysunused file. This reports what disks are attached,
and which
    # ones are being used. Its use spans both the runpower and
runthroughput tests
    system("echo \"The following disks are assigned to the indicated
volume groups\" > $runDir/sysunused$runNum") && die "cannot create
$runDir/sysunused$runNum";

    system("lsps >> $runDir/sysunused$runNum");
    system("echo \"The following volume groups are currently online\" >>
$runDir/sysunused$runNum");
    $curTs = `perl gettimestamp "long"`;
    system("echo \"$curTs\" >> $runDir/sysunused$runNum");
    system("lsvg -o >> $runDir/sysunused$runNum");
}
else
{
    # for all other platforms
    system("echo Assume that all portions of the system are used >>
$runDir${delim}sysunused$runNum");
}

&getConfig("p");
if ( $rootPriv eq "yes" )
{
    # get the o/s tuning parameters...currently AIX only and only if your
# user has root privileges to run this
    &getOSTune("p");
}
if ($gatherstats eq "on")
{
    # gather vm io and net stats
    if ($platform eq "aix" || $platform eq "sun" || $platform eq "ptx" ||
    $platform eq "hp")
    {
        # gather vmstats and iostats (and net stats if in mpp mode)
        system("perl getstats p &");
    }
    else
    {
        print "Stats gather not set up for current platform $platform\n";
    }
}

# print to screen what type of run is running and set variables to run
# the query and update streams in parallel

```

```

if ($runUF ne "UF")
{
    $semcontrol = "off";
    print "Beginning power stream....no update functions\n";

    $streamEx = "";
    $streamExNT = "";
}
else
{
    $semcontrol = "on";
    print "Beginning power stream....with update functions\n";
    if ( $platform eq "nt" )
    {
        $streamExNT = "start /b";
        $streamEx = "";
    }
    else
    {
        $streamExNT = "";
        $streamEx = "&";
    }
}

# bbe This new line (below) runs queries for power test
$ret=system("$streamExNT
$auditDir${delim}auditruns${delim}tpcdbatch -d $dbname -f
$runDir${delim}qtextpow.sql -r on -b on -s $sf -u p1 -m $inlistmax -n 0 -
l $auditDir${delim}auditruns${delim}querytext${delim}streampow.list -p
$semcontrol $streamEx");

if ( $runUF eq "UF" )
{
    $ret2 = system("$auditDir${delim}auditruns${delim}tpcdbatch -d
$dbname -f $runDir${delim}qtextquf.sql -r on -b on -s $sf -u p2 -m
$inlistmax -n 0 -l
$auditDir${delim}auditruns${delim}querytext${delim}streampuf.list");
}
else
{
    $ret2 = 0; # If UFs were not running, then the stream cannot fail
}

if (($ret2 == 0) && ($ret == 0))
{
    print "Power stream completed succesfully.\n";
}
else
{
    print "Power stream failed. ret=$ret\n";
}

if ($platform eq "aix")
{
    # show that the same disks are still used or unused
    system("getdisks \"After completion of the Power Test\"");

    #clean up
}
if ($gatherstats eq "on")
{
    # kill vm io and net stats
    if ($platform eq "aix" || $platform eq "sun" || $platform eq "ptx" ||
        $platform eq "hp")
    {
        system("perl killstats &");
    }
    else
}

```

```

{
    print "Stats gather not set up for current platform $platform\n";
}
}

open(MISO, ">>$misofile") || die "Can't open $misofile: $!\n";
$curTs = `perl gettimestamp "long"`;
print MISO "Timestamp and isolation level of tpcdbatch after power run
at : $curTs\n";
close(MISO);

if ( $product eq "pe" )
{
    system("db2 \"connect to $dbname\": db2 \"select
name,creator,valid,unique_id,isolation from sysibm.sysplan where
name like 'TPCD%'\";db2 connect reset;db2 terminate >>
$runDir${delim}miso$runNum");
}
else
{
    &verifyTPCDBatch("$misofile","$dbname");
}
if ( $RealAudit ne "yes" )
{
    $curTs = `perl gettimestamp "short"`;
    # grab the db and dbm snapshot before we deactivate
    system("db2 get snapshot for all on $dbname >
$runDir${delim}dbrun$runNum.snap.$curTs");
    system("db2 get snapshot for database manager >>
$runDir${delim}dbrun$runNum.snap.$curTs");
}

#####

# now copy the reports from the count of streams files into one final file
&cat("$runDir${delim}pstrcnt","$runDir${delim}mpstrcnt$runNum");
#(NOTE: there is a dependancy that this mpstrcnt file exist before the
# calcmetrics.pl script is called, both because it is used as input for
# calcmetrics.pl, and because the output from calcmetrics is used as
# the trigger for watchstreams to complete, and watchstreams cats its
# output at the end of the mstrcnt file.

# generate the mpinter?.metrics file in the run directory
if ( $runUF eq "UF" )
{
    system("perl calcmetricsp.pl UF");
}
else
{
    system("perl calcmetricsp.pl");
}

# concatenate all the throughput inter files that were used to
# generate these results into the calcmetrics output file
(mpinterX.metrics)
&cat("$runDir${delim}mpqinter*","$runDir${delim}mpinter$runNum.met
rics");

if ($runUF eq "UF" ) {

&cat("$runDir${delim}mpufinter*","$runDir${delim}mpinter$runNum.met
rics");
}

#####

1;

sub getConfig
{

```

```

$testtype=${_}[0];
print "Getting database configuration.\n";
$dbtunefile="$runDir${delim}m${testtype}dbtune${runNum}";
open(DBTUNE, ">$dbtunefile") || die "Can't open $dbtunefile: $!\n";
$timestamp= perl gettimestamp "long";
print DBTUNE "Database and Database manager configuration taken
at : $timestamp";
# get library info for tsumami
print DBTUNE "\nLIBRARYS\n-----\n";
close(DBTUNE);
system("ls -l /install/libs/*.current >> $dbtunefile");
system("ls -lL /install/libs/*.current >> $dbtunefile");

#system("ls -l ~/tpcd/custom/bpvars.cfg >> $dbtunefile");
system("ls -l `db2set | grep DB2BPVARS | cut -b 11-` >>
$dbtunefile");
#system("cat ~/tpcd/custom/bpvars.cfg >> $dbtunefile");
system("cat `db2set | grep DB2BPVARS | cut -b 11-` >> $dbtunefile");

system("db2level >> $dbtunefile");
system("db2 get database configuration for $dbname >>
$dbtunefile");
system("db2 get database manager configuration >> $dbtunefile");
system("db2set >> $dbtunefile");
if (( $mode eq "mln" ) || ( $mode eq "mpp" ))
{
    $cfgfile="$runDir${delim}dbtune${runNum}. ";
    #removed by Alex due to hang
    #system("db2_all `||` typeset -i ln=##; db2 get db cfg for $dbname >
$cfgfile\${ln} ; db2 get dbm cfg >> $cfgfile\${ln}; db2set >>
$cfgfile\${ln}; db2 terminate """);
}
}

sub getOSTune
{
    $testtype=${_}[0];
    if ( $platform eq "aix" )
    {
        print "Getting OS and VMdatabase configuration.\n";
        $ostunefile="$runDir${delim}m${testtype}ostune${runNum}";
        system("rah 'GetSysConfig $runDir${delim}sysconfig'");
        system("rah 'runas root ${delim}usr${delim}sbin${delim}vmo -a' >>
$ostunefile");
        system("rah 'runas root ${delim}usr${delim}sbin${delim}joo -a' >>
$ostunefile");
        system("rah 'runas root ${delim}usr${delim}sbin${delim}no -a' >>
$ostunefile");
        system("rah 'runas root ${delim}usr${delim}bin${delim}svmon -G'
>> $ostunefile");
        system("rah '${delim}usr${delim}bin${delim}ipcs -ma' >>
$ostunefile");
        system("rah 'env' >> $ostunefile");
    }
    else
    {
        print "OS parameters retrieval not supported for $platform \n";
    }
}

sub verifyTPCDBatch
{
    $logfile=${_}[0];
    $dbname=${_}[1];
    $file="verifytpcdbatch.clp";
    open(VERTBL, ">$file") || die "Can't open $file: $!\n";
    print VERTBL "connect to $dbname;\n";

```

```

print VERTBL "select name,creator,valid,last_bind_time,isolation from
sysibm.sysplan where name like 'TPCD%';\n";
print VERTBL "connect reset;\n";
print VERTBL "terminate;\n";
close(VERTBL);
system("db2 -vtf $file >> $logfile");
}

```

D.6 runthroughput

```

: # *-Perl*-
eval `exec perl -S $0 ${1+"$@"}` # Horrible kludge to convert this
if 0; # into a "portable" perl script

# usage runthroughput [UF]
# where UF is the optional parameter that says to run the throughput
test
# with the update functions. By default, the update functions are not
# run
# If UF is not supplied and a number is supplied, then that number is
taken
# as the number of concurrent throughput streams to run. This is also
optional

push(@INC, split(':', $ENV{'PATH'}));

# Get TPC-D specific environment variables
require 'getvars';

# Use the macros in here so that they can handle the platform
differences.
# macro.pl should be sourced from cmvc, other people wrote and
maintain it.
require "macro.pl";
require "tpcdmacro.pl";

$runUF="no";
if (@ARGV > 0)
{
    if ($ARGV[0] eq "UF")
    {
        $runUF=$ARGV[0];
    }
}

if (length($ENV{"TPCD_AUDIT_DIR"}) <= 0)
{
    die "TPCD_AUDIT_DIR environment variable not set\n";
}
if (length($ENV{"TPCD_RUN_DIR"}) <= 0)
{
    die "TPCD_RUN_DIR environment variable not set\n";
}
if (length($ENV{"TPCD_DBNAME"}) <= 0)
{
    die "TPCD_DBNAME environment variable not set\n";
}
if (length($ENV{"TPCD_RUNNUMBER"}) <= 0)
{
    die "TPCD_RUNNUMBER environment variable not set\n";
}
if (length($ENV{"TPCD_NUMSTREAM"}) <= 0)
{
    die "TPCD_NUMSTREAM environment variable not set\n";
}
if (length($ENV{"TPCD_RUN_ON_MULTIPLE_NODES"}) <= 0)
{
    die "TPCD_RUN_ON_MULTIPLE_NODES environment variable not
set\n";
}
}

```

```

if (length($ENV{"TPCD_SF"}) <= 0)
{
  die "TPCD_SF environment variable not set\n";
}
if (length($ENV{"TPCD_PRODUCT"}) <= 0)
{
  die "TPCD_PRODUCT environment variable not set\n";
}
if (length($ENV{"TPCD_PLATFORM"}) <= 0)
{
  die "TPCD_PLATFORM environment variable not set\n";
}
if (length($ENV{"TPCD_AUDIT"}) <= 0)
{
  die "Must set TPCD_AUDIT env't var. Real audit timing sequence
run if yes\n";
}
if (length($ENV{"TPCD_LOG_DIR"}) <= 0)
{
  $ENV{"TPCD_LOG_DIR"} = "NULL";
}
if (length($ENV{"TPCD_MODE"}) <= 0)
{
  die "TPCD_MODE environment variable not set - uni/smp/mln \n";
}
if (length($ENV{"TPCD_ROOTPRIV"}) <= 0)
{
  die "TPCD_ROOTPRIV environment variable not set - yes/no \n";
}

#set up local variables
$runNum=$ENV{"TPCD_RUNNUMBER"};
$numStream=$ENV{"TPCD_NUMSTREAM"};
$runDir=$ENV{"TPCD_RUN_DIR"};
$auditDir=$ENV{"TPCD_AUDIT_DIR"};
$dbname=$ENV{"TPCD_DBNAME"};
$sf=$ENV{"TPCD_SF"};
$product=$ENV{"TPCD_PRODUCT"};
$multinode=$ENV{"TPCD_RUN_ON_MULTIPLE_NODES"};
$platform=$ENV{"TPCD_PLATFORM"};
$delim=$ENV{"TPCD_PATH_DELIM"};
$RealAudit=$ENV{"TPCD_AUDIT"};
$inlistmax=$ENV{"TPCD_INLISTMAX"};
$gatherstats=$ENV{"TPCD_GATHER_STATS"};
$logDir=$ENV{"TPCD_LOG_DIR"};
$rootPriv=$ENV{"TPCD_ROOTPRIV"};
$mode=$ENV{"TPCD_MODE"};

$path="$auditDir${delim}auditruns";

if ( ( $mode eq "uni" ) || ( $mode eq "smp" ) )
{
  $all_in="once";
  $all_pn="once";
  $once="once";
}
else
{
  $all_in="all_in";
  $all_pn="all_pn";
  $once="once";
}

# return 1 if the given pattern(parameter $_[0]) matches any file
sub existfile {
  if ($platform eq "aix" || $platform eq "sun" || $platform eq "ptx")
  {
    `ls $_[0] 2> /dev/null | wc -l` + 0 != 0;
  }
  else

```

```

{
  `dir /b $_[0] 2> NUL | wc -l` + 0 != 0;
}
}

if ($inlistmax eq "default")
{
  $inlistmax = 400;
}

$misofile="$runDir${delim}miso$runNum";
# append isolation level information about tpcdbatch to the miso file
open(MISO, ">>$misofile") || die "Can't open $misofile: $!\n";
$curTs = `perl gettimestamp "long"`;
print MISO "Timestamp and isolation level of tpcdbatch before
throughput run at : $curTs\n";
close(MISO);

if ( $product eq "pe" )
{
  system("db2 \\'connect to $dbname\'; db2 \\'select
name,creator,valid,unique_id,isolation from sysibm.sysplan where
name like 'TPCD%\' >> $runDir${delim}miso$runNum ");
}
else
{
  &verifyTPCdbatch("$misofile","$dbname");
}

# kick off the script that will monitor for the database applications
during
# the running of the throughput tests. This will quit when the
mtinterX.metrics
# (where X=runnumber) file has been created.

# set variables to run streams in parallel
if ( $platform eq "nt" )
{
  $streamExNT = "start /b";
  $streamEx = "";
}
else
{
  $streamExNT = "";
  $streamEx = "&";
}
if ( $platform eq "aix" || $platform eq "sun" || $platform eq "nt" ||
$platform eq "hp" )
{
  system("$streamExNT perl watchstreams $streamEx");
}
else
{
  die "platform not supported, can't start watchstreams in
background";
}

# show the disks that are used/unused
if ($platform eq "aix")
{
  system("getdisks \\'Before the start of the Throughput Test\''");
}

&getConfig("t");
if ( $rootPriv eq "yes" )
{
  # get the o/s tuning parameters...currently AIX only and only if your
# user has root privileges to run this
&getOSTune("t");
}
}

```

```

if ($gatherstats eq "on")
{
  # gather vm io and net stats
  if ($platform eq "aix" || $platform eq "sun" || $platform eq "ptx" ||
  $platform eq "hp")
  {
    # gather vmstats and iostats (and net stats if in mpp mode)
    system("perl getstats t &");
  }
  else
  {
    print "Stats gather not set up for current platform $platform\n";
  }
}

if ( $multinode ne "yes" )
{
  # we are running the query streams and update stream from the same
  # node or
  # from a serial db....use semaphores for control of the update stream

  # the auditruns directory is where we have already generated the sql
  # files
  # for the updates and the power tests

  $loopStream=1;

  for ( $loopStream = 1; $loopStream <= $numStream; $loopStream++)
  {
    print "starting stream $loopStream\n";
    system("echo Executing stream $loopStream out of $numStream.");
    # run the queries
    if ( $platform eq "aix" || $platform eq "sun" || $platform eq "nt" ||
    $platform eq "ptx" ||
    $platform eq "hp" )
    {
      system("$streamExNT $path${delim}tpcdbatch -d $dbname -f
      $runDir${delim}qtextt$loopStream.sql -r on -b on -s $sf -u t1 -m
      $inlistmax -n $loopStream -l
      $path${delim}querytext${delim}stream$loopStream.list $streamEx");
    }
    else
    {
      die "platform $platform not supported yet";
    }
  }

  # run the update function stream....this will wait until the queries have
  # completed to kick off the updates
  print "starting update stream\n";

  if ($runUF eq "no") {
    $ret=system("$auditDir${delim}auditruns${delim}tpcdbatch -d
    $dbname -f $runDir${delim}quft.sql -r on -b on -s $sf -u t -m $inlistmax
    -n $numStream -l $runDir${delim}streamuf.list");
  }
  else {
    $ret=system("$auditDir${delim}auditruns${delim}tpcdbatch -d
    $dbname -f $runDir${delim}quft.sql -r on -b on -s $sf -u t2 -m $inlistmax
    -n $numStream -l $runDir${delim}streamuf.list");
  }
  print "update stream done\n";
}
else
{
  # we are running the query streams and update stream from different
  # nodes, use
  # files and rksh to control the update stream

```

```

system("runthru.pe");
}

if ($platform eq "aix")
{
  # show the disks that are used/unused
  system("getdisks \"After the completion of the Throughput Test\");
}
if ($gatherstats eq "on")
{
  # kill vm io and net stats
  if ($platform eq "aix" || $platform eq "sun" || $platform eq "ptx" ||
  $platform eq "hp")
  {
    system("perl killstats &");
  }
  else
  {
    print "Stats gather not set up for current platform $platform\n";
  }
}

open(MISO, ">>$misofile") || die "Can't open $misofile: $!\n";
$curTs = `perl gettimestamp "long"`;
print MISO "Timestamp and isolation level of tpcdbatch after
throughput run at : $curTs\n";
close(MISO);

if ( $product eq "pe" )
{
  system("db2 \"connect to $dbname\"; db2 \"select
  name,creator,valid,unique_id,isolation from sysibm.sysplan where
  name like 'TPCD%'\>> $runDir${delim}miso$runNum\";
}
else
{
  &verifyTPCDBatch("$misofile","$dbname");
}

# grab the db and dbm snapshot before we deactivate
# db snapshot shows log pages written
system("getAuditRunInfo");

# now copy the reports from the count of streams files into one final file
&cat("$runDir${delim}strcnt*","$runDir${delim}mstrcnt$runNum");
#(NOTE: there is a dependency that this mstrcnt file exist before the
# calcmetrics.pl script is called, both because it is used as input for
# calcmetrics.pl, and because the output from calcmetrics is used as
# the trigger for watchstreams to complete, and watchstreams cats its
# output at the end of the mstrcnt file.

# generate the mtinter?.metrics file in the run directory
if ( $runUF ne "no")
{
  system("perl calcmetrics.pl $numStream UF");
}
else
{
  system("perl calcmetrics.pl $numStream");
}

# concatenate all the throughput inter files that were used to
# generate these results into the calcmetrics output file
(mtinterX.metrics)
&cat("$runDir${delim}mts*inter*","$runDir${delim}mtinter$runNum.metri
cs");

if ($runUF ne "no") {

```



```

&cat("$runDir${delim}mtufinter*", "$runDir${delim}mtinter$runNum.metr
cs");
}

if (&existfile("$runDir${delim}mp**")) {
# generate the mplot stuff
system("gen_mplot");
}

# deactivate the database this needs to remain at the end of run
throughput so
# asynchronous writing of the log files completes.
system("db2 deactivate database $dbname");

#Create Catalog info
$rc = system("perl catinfo.pl p");

if ( $rc != 0 )
{
warn "catinfo failed!!!\n";
}

# if we are in audit mode we must do a db2stop at the end of the
power/throughput run
if ( $RealAudit eq "yes" )
{
system("db2stop");
}

1;

sub getConfig
{
$testtype=$_[0];
print "Getting database configuration.\n";
$dbtunefile="$runDir${delim}m${testtype}dbtune${runNum}";
open(DBTUNE, ">$dbtunefile") || die "Can't open $dbtunefile: $!\n";
$timestamp=`perl gettimestamp "long"`;
print DBTUNE "Database and Database manager configuration taken
at : $timestamp";

# get library info for tsumami
print DBTUNE "\nLIBRARYS\n-----\n";
close(DBTUNE);
system("ls -l /install/libs/*.current >> $dbtunefile");
system("ls -l /install/libs/*.current >> $dbtunefile");

#system("ls -l ~/tpcd/custom/bpvars.cfg >> $dbtunefile");
system("ls -l `db2set | grep DB2BPVARS | cut -b 11-` >>
$dbtunefile");
#system("cat ~/tpcd/custom/bpvars.cfg >> $dbtunefile");
system("cat `db2set | grep DB2BPVARS | cut -b 11-` >> $dbtunefile");

system("db2level >> $dbtunefile");
system("db2 get database configuration for $dbname >>
$dbtunefile");
system("db2 get database manager configuration >> $dbtunefile");
system("db2set >> $dbtunefile");
}

sub getOSTune
{
$testtype=$_[0];
if ( $platform eq "aix" )
{
print "Getting OS and VMdatabase configuration.\n";
$ostunefile="$runDir${delim}m${testtype}ostune${runNum}";

```

```

#open(OSTUNE, ">$ostunefile") || die "Can't open $ostunefile:
$!\n";
#$timestamp=`perl gettimestamp "long"`;
#print OSTUNE "Operating System and Virtual Memory
configuration taken at : $timestamp";
#close(OSTUNE);

#system("${delim}usr${delim}samples${delim}kernel${delim}schedtune
>> $ostunefile");
#system("rah
'${delim}usr${delim}samples${delim}kernel${delim}vmtune >>
$ostunefile");
system("rah 'runas root ${delim}usr${delim}sbin${delim}vmo -a >>
$ostunefile");
system("rah 'runas root ${delim}usr${delim}sbin${delim}jioo -a >>
$ostunefile");
system("rah 'runas root ${delim}usr${delim}sbin${delim}no -a >>
$ostunefile");
system("rah 'runas root ${delim}usr${delim}bin${delim}svmon -G >>
$ostunefile");
system("rah '${delim}usr${delim}bin${delim}ipcs -ma' >>
$ostunefile");
system("rah 'env' >> $ostunefile");
}
else
{
print "OS parameters retrieval not supported for $platform \n";
}
}

sub verifyTPCDBatch
{
$logfile=$_[0];
$dbname=$_[1];
$file="verifytpcdbatch.clp";
open(VERTBL, ">$file") || die "Can't open $file: $!\n";
print VERTBL "connect to $dbname;\n";
print VERTBL "select name,creator,valid,last_bind_time,isolation from
sysibm.sysplan where name like 'TPCD%';\n";
print VERTBL "connect reset;\n";
print VERTBL "terminate;\n";
close(VERTBL);
system("db2 -vtf $file >> $logfile");
}

```

D.7 ploaduf1

```

#!/bin/ksh
toolsDir=/tpcd/tpcd/tools
InDir=/db/uflinks

RFpair=$1;
$toolsDir/ploaduf1.gruntO $RFpair $InDir&
$toolsDir/ploaduf1.gruntL $RFpair $InDir
wait

```

D.8 ploaduf2

```

#!/bin/ksh
RFpair=$1;
InDir=/db/uflinks

db2 -c +p -svt << EOF

connect to tpcd;
load from delete.$RFpair.new of del modified by coldel| fastparse
messages /dev/null replace into TPCDTEMP.ORDERS_del
nonrecoverable partitioned db config mode load_only part_file_location
$InDir;

```

```
connect reset;
terminate;
```

```
EOF
```

D.9 ploadufl.gruntO

```
#!/bin/ksh
RFpair=$1;
InDir=$2
```

```
db2 -c +p -svt << EOF
```

```
connect to tpcd;
load from orders.u$RFpair.new of del modified by coldel| fastparse
messages /dev/null replace into TPCDTEMP.ORDERS_new
nonrecoverable partitioned db config mode load_only part_file_location
$InDir;
connect reset;
terminate;
```

```
EOF
```

D.10 ploadufl.gruntL

```
#!/bin/ksh
RFpair=$1;
InDir=$2
```

```
db2 -c +p -svt << EOF
```

```
connect to tpcd;
load from lineitem.u$RFpair.new of del modified by coldel| fastparse
messages /dev/null replace into TPCDTEMP.LINEITEM_new
nonrecoverable partitioned db config mode load_only part_file_location
$InDir;
connect reset;
terminate;
```

```
EOF
```

Appendix - E ACID Transaction Source Code

E.1 acid.sqc

```
#include "acid.h"

#if (defined(SQLPTX) || defined(SQLWINT) || defined(SQLSUN) ||
defined(Linux))
double nearest(double);
#endif /* SQLPTX */

#define DEADLOCK -911

/*
#define TRUNC2(d) ((floor((d)*100.0))/100.0)
*/
/*
#define TRUNC2(d) ((floor(nearest((d)*100.0)))*0.01)
*/
/*
#define TRUNC2(d) ((floor(nearest((d)*1000.0)/10.0)/100.0)
*/
#define TRUNC2(d) ((floor(nearest((d)*100000.0)/1000.0)/100.0)

void sqlerror(char * , struct sqlca *);

EXEC SQL INCLUDE SQLCA;
EXEC SQL BEGIN DECLARE SECTION;
char dbname[8]; /* = "tpcd"; */
EXEC SQL END DECLARE SECTION;

#ifdef SQLWINT

/*
** redefine gettimeofday so I don't have to
** change too much aix-specific code
*/
/*#typedef struct timeval { unsigned tv_sec; unsigned tv_usec; }; */
typedef struct timezone { int dummy; };
struct timeb timer;

void gettimeofday( struct timeval *tv, struct timezone *tz)
{
ftime(&timer);
tv->tv_sec = timer.time;
tv->tv_usec = timer.millitm * 1000;
tz->dummy = 0;
}
#endif

/*-----*/
/* acidQ */
/*-----*/
int acidQ (struct acidQ_struct *acid)
{
time_t timeT;
FILE *out;
char out_fn[50];
struct timeval tv;
struct timezone tz;
int mypid;
int rc = 0;
```

```
EXEC SQL BEGIN DECLARE SECTION;
sqlint32 okey;
sqlint32 lEprice;
double eprice;
EXEC SQL END DECLARE SECTION;

okey = acid->o_key;

/* mypid = getpid(); */
mypid = acid->tag;

sprintf(out_fn,
"%s%cacidQ.out.%d",getenv("TPCD_TMP_DIR"),del(),mypid);
out=fopen(out_fn,"a");
if (out == NULL)
{
fprintf(stderr, "ERROR input file %s could not be appended
to!\n",out_fn);
}

gettimeofday(&tv, &tz);
time(&timeT);
fprintf(out, "\n----- START of acidQ tag: %d ----- \n\n", mypid);
fprintf(out, "acidQ tag: %d, begin transaction time: (%us %06uu) %s",
mypid, tv.tv_sec, tv.tv_usec, ctime(&timeT));
fprintf(out, "okey: %d\n", okey);

gettimeofday(&tv, &tz);
time(&timeT);
fprintf(out, "acidQ tag: %d, before read of LINEITEM: (%us %06uu)
%s",
mypid, tv.tv_sec, tv.tv_usec, ctime(&timeT));

/*
** use the same sql code as used in the consistsql.pl to
** run the consistency acid queries. Note we assign a long int
** to lEprice (we make it 10s of pennies by * 1000). Then divide
** by 1000.0 and cast it to a double (eprice) for printing
*/

EXEC SQL
SELECT

INTEGER(DECIMAL(SUM(DECIMAL(INTEGER(INTEGER(DECIMAL
(INTEGER(100*DECIMAL(L_EXTENDEDPRI,20,3)), 20,3) *
(1-L_DISCOUNT)) * (1+L_TAX)),20,3)/100.0),20,3) * 1000)
into :lEprice
FROM
TPCD.LINEITEM
WHERE
L_ORDERKEY = :okey;

if (sqlca.sqlcode != 0) {
rc = sqlca.sqlcode;
fprintf(out, "acidQ **ERROR** sqlcode = %d\n", sqlca.sqlcode);
sqlerror("acidQ: select sum(l_extendedprice)", &sqlca);
goto Qerror;
}
eprice = (double)lEprice / 1000.0; /* translate to double for printout*/

gettimeofday(&tv, &tz);
time(&timeT);
fprintf(out, "ACID tag: %d, after read of LINEITEM: (%us %06uu) %s",
mypid, tv.tv_sec, tv.tv_usec, ctime(&timeT));
fprintf(out, "okey: %d lt sum(l_extendedprice): %0.3f\n",
okey, eprice);

EXEC SQL COMMIT;
if (sqlca.sqlcode != 0) {
rc = sqlca.sqlcode;
```

```

    fprintf(out,"acidQ **ERROR** sqlcode = %d\n",sqlca.sqlcode);
    sqlerror("acidQ: COMMIT", &sqlca);
    goto Qerror;
}
acid->l_extendedprice = eprice;

rc = 0;
goto Qexit;

Qerror:
EXEC SQL rollback work;
if (sqlca.sqlcode != 0) sqlerror("acidQ: ROLLBACK FAILED", &sqlca);

Qexit:
fprintf(out,"\n----- END of acidQ tag: %d ----- \n\n",mypid);
fflush(out);fclose(out);
return(rc);
}

/*-----*/
/*   ast_acidQ                               */
/*-----*/
int ast_acidQ (struct acidQ_struct *acid)
{
    time_t timeT;
    FILE *out;
    char out_fn[50];
    struct timeval tv;
    struct timezone tz;
    int mypid;
    int rc = 0;

    EXEC SQL BEGIN DECLARE SECTION;
    double ast_IEprice;
    double ast_eprice;
    EXEC SQL END DECLARE SECTION;

    /* mypid = getpid(); */
    mypid = acid->tag;

    sprintf(out_fn,
"%s%cast_acidQ.out.%d",getenv("TPCD_TMP_DIR"),del(),mypid);
    out=fopen(out_fn,"a");
    gettimeofday(&tv, &tz);
    time(&timeT);
    fprintf(out,"\n----- START of ast_acidQ tag: %d -----
\n\n",mypid);
    fprintf(out, "ast_acidQ tag: %d, begin transaction time: (%us %06uu)
%s",
        mypid, tv.tv_sec, tv.tv_usec, ctime(&timeT));

    gettimeofday(&tv, &tz);
    time(&timeT);
    fprintf(out,"ast_acidQ tag: %d, before read of LINEITEM: (%us
%06uu) %s",
        mypid, tv.tv_sec, tv.tv_usec, ctime(&timeT));

    /*
** use the same query acidQ except don't select for specific okay.
** this ensures that the ast will be used instead of the base table
** Have to use ast_IEprice as double since this sum is so big
*/
    EXEC SQL
    SELECT
    SUM ( L_EXTENDEDPRI*(1-L_DISCOUNT)*(1 + L_TAX))
    into :ast_IEprice
    FROM
    TPCD.LINEITEM;

```

```

if (sqlca.sqlcode != 0) {
    rc = sqlca.sqlcode;
    fprintf(out,"ast_acidQ **ERROR** sqlcode = %d\n",sqlca.sqlcode);
    sqlerror("ast_acidQ: select sum(l_extendedprice)", &sqlca);
    goto Qerror;
}
ast_eprice = ast_IEprice; /* use ast_eprice for printout to be
consistent*/

    gettimeofday(&tv, &tz);
    time(&timeT);
    fprintf(out,"AST_ACID tag: %d, after read of LINEITEM: (%us
%06uu) %s",
        mypid, tv.tv_sec, tv.tv_usec, ctime(&timeT));
    fprintf(out, "sum(l_extendedprice): %0.3f\n",
        ast_eprice);

    EXEC SQL COMMIT;
    if (sqlca.sqlcode != 0) {
        rc = sqlca.sqlcode;
        fprintf(out,"ast_acidQ **ERROR** sqlcode = %d\n",sqlca.sqlcode);
        sqlerror("ast_acidQ: COMMIT", &sqlca);
        goto Qerror;
    }
    acid->l_extendedprice = ast_eprice;

    rc = 0;
    goto Qexit;

Qerror:
EXEC SQL rollback work;
if (sqlca.sqlcode != 0) sqlerror("ast_acidQ: ROLLBACK FAILED",
&sqlca);

Qexit:
fprintf(out,"\n----- END of ast_acidQ tag: %d ----- \n\n",mypid);
fflush(out);fclose(out);
return(rc);
}

/*-----*/
/*   acidT                                   */
/*-----*/
int acidT (struct acidT_struct *acid)
{
    time_t timeT;
    FILE *out;
    char out_fn[50];
    struct timeval tv;
    struct timezone tz;
    int mypid;
    int rc = 0;

    EXEC SQL BEGIN DECLARE SECTION;
    sqlint32 o_key, l_key, delta;
    sqlint32 l_partkey, l_suppkey;
    double l_quantity, l_tax, l_discount, l_extendedprice;
    double o_totalprice;
    double new_quantity, rprice, cost, new_extprice, new_otal, ototal;
    EXEC SQL END DECLARE SECTION;

    EXEC SQL DECLARE l_cursor CURSOR FOR
    SELECT l_partkey, l_suppkey, l_quantity,
    l_tax, l_discount,
    l_extendedprice
    FROM tpcd.lineitem
    WHERE l_orderkey = :o_key
    AND l_linenum = :l_key
    FOR UPDATE OF l_extendedprice, l_quantity;

```

```

EXEC SQL DECLARE o_cursor CURSOR FOR
  SELECT o_totalprice
  FROM tpcd.orders
  WHERE o_orderkey = :o_key
  FOR UPDATE OF o_totalprice;

if (acid->termination < 0 || acid->termination > 3) acid->termination =
0;
o_key = acid->o_key;
l_key = acid->l_key;
delta = acid->delta;

if (acid->logging) {
  /* mypid = getpid(); */
  mypid = acid->tag;
  sprintf(out_fn,
"%s%cacidT.out.%d",getenv("TPCD_TMP_DIR"),del(),mypid);
  out=fopen(out_fn,"a");
  gettimeofday(&tv, &tz);
  time(&timeT);
  fprintf(out, "\n----- START of acidT tag: %d -----\n\n",mypid);
  fprintf(out, "acidT tag: %d, begin transaction time: (%us %06uu)
%s",
    mypid, tv.tv_sec, tv.tv_usec, ctime(&timeT));
  fprintf(out, "o_key: %d\tl_key: %d\tdelta: %d\n", o_key, l_key,
delta);
}
#ifdef DEBUG
  printf("o_key: %d\tl_key: %d\tdelta: %d\n", o_key, l_key, delta);
#endif

retry_tran:

if (acid->logging) {
  gettimeofday(&tv, &tz);
  time(&timeT);
  fprintf(out, "acidT tag: %d, before read of LINEITEM: (%us %06uu)
%s",
    mypid, tv.tv_sec, tv.tv_usec, ctime(&timeT));
}

EXEC SQL OPEN l_cursor;
if (sqlca.sqlcode != 0) {
  if (sqlca.sqlcode == DEADLOCK) goto retry_tran;
  rc = sqlca.sqlcode;
  if (acid->logging) {
    fprintf(out, "acidT **ERROR** sqlcode = %d\n", sqlca.sqlcode);
  } else {
    fprintf(stderr, "acidT **ERROR** sqlcode = %d\n", sqlca.sqlcode);
  } /* endif */
  sqlerror("acidT: OPEN l_cursor", &sqlca);
  goto Terror;
}

EXEC SQL FETCH l_cursor INTO
:l_partkey, :l_suppkey, :l_quantity, :l_tax,
:l_discount, :l_extendedprice;
if (sqlca.sqlcode != 0) {
  if (sqlca.sqlcode == DEADLOCK) goto retry_tran;
  rc = sqlca.sqlcode;
  if (acid->logging) {
    fprintf(out, "acidT **ERROR** sqlcode = %d\n", sqlca.sqlcode);
  } else {
    fprintf(stderr, "acidT **ERROR** sqlcode = %d\n", sqlca.sqlcode);
  } /* endif */
  sqlerror("acidT: FETCH l_cursor", &sqlca);
  goto Terror;
}

```

```

#ifdef DEBUG
  printf("l_quantity = %0.3f\n", l_quantity);
  printf("l_tax = %0.3f \n", l_tax);
  printf("l_discount = %0.3f\n", l_discount);
  printf("l_extendedprice = %0.3f \n", l_extendedprice);
#endif

if (acid->logging) {
  gettimeofday(&tv, &tz);
  time(&timeT);
  fprintf(out, "acidT tag: %d, after read of LINEITEM: (%us %06uu)
%s",
    mypid, tv.tv_sec, tv.tv_usec, ctime(&timeT));
  fprintf(out, "l_partkey: %d l_suppkey: %d l_quantity: %0.3f\nl_tax:
%0.3f l_discount: %0.3f l_extendedprice: %0.3f\n",
    l_partkey, l_suppkey, l_quantity, l_tax, l_discount,
l_extendedprice);
}

rprice = TRUNC2( l_extendedprice/l_quantity );
cost = TRUNC2( rprice * delta );
new_extprice = l_extendedprice + cost;
new_quantity = l_quantity + delta;

#ifdef DEBUG
  printf("rprice = %0.3f\n", rprice );
  printf("cost = %0.3f\n", cost );
  printf("new_extprice = %0.3f\n", new_extprice );
  printf("new_quantity = %0.3f\n", new_quantity );
#endif

EXEC SQL UPDATE tpcd.lineitem
  SET l_extendedprice = :new_extprice,
      l_quantity = :new_quantity
  WHERE CURRENT OF l_cursor;

if (sqlca.sqlcode != 0) {
  if (sqlca.sqlcode == DEADLOCK) goto retry_tran;
  rc = sqlca.sqlcode;
  if (acid->logging) {
    fprintf(out, "acidT **ERROR** sqlcode = %d\n", sqlca.sqlcode);
  } else {
    fprintf(stderr, "acidT **ERROR** sqlcode = %d\n", sqlca.sqlcode);
  } /* endif */
  sqlerror("acidT: UPDATE l_cursor", &sqlca);
  goto Terror;
}

if (acid->logging) {
  gettimeofday(&tv, &tz);
  time(&timeT);
  fprintf(out, "acidT tag: %d, after update of LINEITEM: (%us %06uu)
%s",
    mypid, tv.tv_sec, tv.tv_usec, ctime(&timeT));
  fprintf(out, "updated l_extendedprice: %0.3f\n", new_extprice );
  fprintf(out, "updated l_quantity: %0.3f\n", new_quantity );
}

/* if (acid->termination == 0) {
  EXEC SQL CLOSE l_CURSOR;
  EXEC SQL CLOSE o_CURSOR;
  EXEC SQL COMMIT;
  if (sqlca.sqlcode != 0) {
    if (sqlca.sqlcode == DEADLOCK) goto retry_tran;
    rc = sqlca.sqlcode;
    if (acid->logging) {
      fprintf(out, "acidT **ERROR** sqlcode = %d\n", sqlca.sqlcode);
    } else {
      fprintf(stderr, "acidT **ERROR** sqlcode = %d\n", sqlca.sqlcode);
    }
  }
}

```

```

    }
    sqlerror("acidT: COMMIT", &sqlca);
    goto Terror;
}
}*/

if (acid->logging) {
    gettimeofday(&tv, &tz);
    time(&timeT);
    fprintf(out,"acidT tag: %d, before read of ORDER: (%us %06uu)
%s",
        mypid, tv.tv_sec, tv.tv_usec, ctime(&timeT));
}

EXEC SQL OPEN o_cursor;
if (sqlca.sqlcode != 0) {
    if (sqlca.sqlcode == DEADLOCK) goto retry_tran;
    rc = sqlca.sqlcode;
    if (acid->logging) {
        fprintf(out,"acidT **ERROR** sqlcode = %d\n",sqlca.sqlcode);
    } else {
        fprintf(stderr,"acidT **ERROR** sqlcode = %d\n",sqlca.sqlcode);
    } /* endif */
    sqlerror("acidT: OPEN o_cursor", &sqlca);
    goto Terror;
}

EXEC SQL FETCH o_cursor INTO :o_totalprice;
if (sqlca.sqlcode != 0) {
    if (sqlca.sqlcode == DEADLOCK) goto retry_tran;
    rc = sqlca.sqlcode;
    if (acid->logging)
    {
        fprintf(out,"acidT **ERROR** sqlcode = %d\n",sqlca.sqlcode);
    }
    else
    {
        fprintf(stderr,"acidT **ERROR** sqlcode = %d\n",sqlca.sqlcode);
    }
    sqlerror("acidT: FETCH o_cursor", &sqlca);
    goto Terror;
}

#ifdef DEBUG
    printf("o_totalprice = %0.3f\n",o_totalprice);
#endif

if (acid->logging) {
    gettimeofday(&tv, &tz);
    time(&timeT);
    fprintf(out,"acidT tag: %d, after read of ORDER: (%us %06uu) %s",
        mypid, tv.tv_sec, tv.tv_usec, ctime(&timeT));
    fprintf(out, "o_totalprice: %0.3f\n", o_totalprice);
}

#ifdef DEBUG
{
    double zeroone= l_extendedprice * (1.0- l_discount);
    double zeroonetimes= (l_extendedprice * (1.0- l_discount))*100.0;
    double firstone = TRUNC2(l_extendedprice * (1.0-l_discount));
    double notone= TRUNC2( l_extendedprice * (1.0-l_discount) *
(1.0+l_tax);
    double secondone= TRUNC2( TRUNC2( l_extendedprice * (1.0-
l_discount) ) * (1.0+l_tax) );
    printf("firstone= %f\n", firstone);
    printf("zeroone= %f\n", zeroone);
    printf("zeroonetimes= %f\n", zeroonetimes);
    printf("notone= %f\n", notone);
    printf("secondone= %f\n", secondone);
}
}

```

```

#endif
    ototal = o_totalprice -
        TRUNC2( TRUNC2( l_extendedprice * (1-l_discount) ) *
(1+l_tax) );
    new_ototal = TRUNC2( new_extprice * (1.0-l_discount) );
    new_ototal = TRUNC2( new_ototal * (1.0+l_tax) );
    new_ototal = ototal + new_ototal;

#ifdef DEBUG
    printf("o_totalprice= %f\n",o_totalprice);
    printf("ototal= %0.3f\n",ototal);
    printf("ototal= %f\n",ototal);
    printf("new_ototal= %0.3f\n",new_ototal);
#endif

EXEC SQL UPDATE tpcd.orders
    SET o_totalprice = :new_ototal
    WHERE CURRENT OF o_cursor;
if (sqlca.sqlcode != 0) {
    if (sqlca.sqlcode == DEADLOCK) goto retry_tran;
    rc = sqlca.sqlcode;
    if (acid->logging) {
        fprintf(out,"acidT **ERROR** sqlcode = %d\n",sqlca.sqlcode);
    } else {
        fprintf(stderr,"acidT **ERROR** sqlcode = %d\n",sqlca.sqlcode);
    } /* endif */
    sqlerror("acidT: UPDATE o_cursor", &sqlca);
    goto Terror;
}

if (acid->logging) {
    gettimeofday(&tv, &tz);
    time(&timeT);
    fprintf(out,"acidT tag: %d, after update of ORDER: (%us %06uu)
%s",
        mypid, tv.tv_sec, tv.tv_usec, ctime(&timeT));
    fprintf(out, "updated o_totalprice: %0.3f\n", new_ototal) ;
}

/*
** why is this code in here? we don't want to
** commit until the history table has been updated as well
if (acid->termination == 0) {
    EXEC SQL CLOSE L_CURSOR;
    EXEC SQL CLOSE O_CURSOR;
    EXEC SQL COMMIT;
    if (sqlca.sqlcode != 0) {
        if (sqlca.sqlcode == DEADLOCK) goto retry_tran;
        rc = sqlca.sqlcode;
        if (acid->logging) {
            fprintf(out,"acidT **ERROR** sqlcode = %d\n",sqlca.sqlcode);
        } else {
            fprintf(stderr,"acidT **ERROR** sqlcode = %d\n",sqlca.sqlcode);
        }
        sqlerror("acidT: COMMIT", &sqlca);
        goto Terror;
    }
}
*/

if (acid->logging) {
    gettimeofday(&tv, &tz);
    time(&timeT);
    fprintf(out,"acidT tag: %d, before insert into HISTORY: (%us
%06uu) %s",
        mypid, tv.tv_sec, tv.tv_usec, ctime(&timeT));
}

EXEC SQL INSERT INTO tpcd.history values

```

```

(:l_partkey, :l_supkey, :o_key, :l_key, :delta, CURRENT
TIMESTAMP);
if (sqlca.sqlcode != 0) {
if (sqlca.sqlcode == DEADLOCK) goto retry_tran;
rc = sqlca.sqlcode;
if (acid->logging) {
fprintf(out,"acidT **ERROR** sqlcode = %d\n",sqlca.sqlcode);
} else {
fprintf(stderr,"acidT **ERROR** sqlcode = %d\n",sqlca.sqlcode);
} /* endif */
sqlerror("acidT: INSERT INTO history", &sqlca);
goto Terror;
}

if (acid->logging) {
gettimeofday(&tv, &tz);
time(&timeT);
fprintf(out,"acidT tag: %d, after insert into HISTORY: (%us %06uu)
%s",
mypid, tv.tv_sec, tv.tv_usec, ctime(&timeT));
}

/* sleep for 1 second for 80% of the transactions */
#ifdef SQLWINT
if ( ((rand() % (100)) + 1) < 80 ) sleep(1);
#else
if ( ((random() % (100)) + 1) < 80 ) sleep(1);
#endif

switch (acid->termination) {
case 1:
{
if (acid->logging)
{
gettimeofday(&tv, &tz);
time(&timeT);
fprintf(out,"acidT tag: %d, wait before COMMIT: (%us %06uu)
%s",
mypid, tv.tv_sec, tv.tv_usec, ctime(&timeT));
}
sleep(60);
}
case 0:
/* gjc@011214 */
if (acid->logging) {
gettimeofday(&tv, &tz);
time(&timeT);
fprintf(out,"acidT tag: %d, immediately before closing cursors:
(%us %06uu) %s",
mypid, tv.tv_sec, tv.tv_usec, ctime(&timeT));
}
EXEC SQL CLOSE L_CURSOR;
/* gjc@011214. */
if (sqlca.sqlcode != 0) {
if (sqlca.sqlcode == DEADLOCK) goto retry_tran;
rc = sqlca.sqlcode;
if (acid->logging) {
fprintf(out,"acidT **ERROR** sqlcode = %d\n",sqlca.sqlcode);
} else {
fprintf(stderr,"acidT **ERROR** sqlcode = %d\n",sqlca.sqlcode);
} /* endif */
sqlerror("acidT: Close L_CURSOR", &sqlca);
goto Terror;
}

EXEC SQL CLOSE O_CURSOR;
/* gjc@011214. */
if (sqlca.sqlcode != 0) {
if (sqlca.sqlcode == DEADLOCK) goto retry_tran;

```

```

rc = sqlca.sqlcode;
if (acid->logging) {
fprintf(out,"acidT **ERROR** sqlcode = %d\n",sqlca.sqlcode);
} else {
fprintf(stderr,"acidT **ERROR** sqlcode = %d\n",sqlca.sqlcode);
} /* endif */
sqlerror("acidT: Close O_CURSOR", &sqlca);
goto Terror;
}

if (acid->logging) {
gettimeofday(&tv, &tz);
time(&timeT);
fprintf(out,"acidT tag: %d, immediately before COMMIT: (%us
%06uu) %s",
mypid, tv.tv_sec, tv.tv_usec, ctime(&timeT));
}
EXEC SQL COMMIT;
if (sqlca.sqlcode != 0) {
if (sqlca.sqlcode == DEADLOCK) goto retry_tran;
rc = sqlca.sqlcode;
if (acid->logging) {
fprintf(out,"acidT **ERROR** sqlcode = %d\n",sqlca.sqlcode);
} else {
fprintf(stderr,"acidT **ERROR** sqlcode = %d\n",sqlca.sqlcode);
} /* endif */
sqlerror("acidT: COMMIT", &sqlca);
goto Terror;
}

if (acid->logging) {
gettimeofday(&tv, &tz);
time(&timeT);
fprintf(out,"acidT tag: %d, after COMMIT: (%us %06uu) %s",
mypid, tv.tv_sec, tv.tv_usec, ctime(&timeT));
}
break;
case 3:
if (acid->logging) {
gettimeofday(&tv, &tz);
time(&timeT);
fprintf(out,"acidT tag: %d, wait before ROLLBACK: (%us %06uu)
%s",
mypid, tv.tv_sec, tv.tv_usec, ctime(&timeT));
}
sleep(60);
case 2:
if (acid->logging) {
gettimeofday(&tv, &tz);
time(&timeT);
fprintf(out,"acidT tag: %d, immediately before closing cursors:
(%us %06uu) %s",
mypid, tv.tv_sec, tv.tv_usec, ctime(&timeT));
}
EXEC SQL CLOSE L_CURSOR;
/* gjc@011214. */
if (sqlca.sqlcode != 0) {
if (sqlca.sqlcode == DEADLOCK) goto retry_tran;
rc = sqlca.sqlcode;
if (acid->logging) {
fprintf(out,"acidT **ERROR** sqlcode = %d\n",sqlca.sqlcode);
} else {
fprintf(stderr,"acidT **ERROR** sqlcode = %d\n",sqlca.sqlcode);
} /* endif */
sqlerror("acidT: Close L_CURSOR", &sqlca);
goto Terror;
}

EXEC SQL CLOSE O_CURSOR;
/* gjc@011214. */
if (sqlca.sqlcode != 0) {
if (sqlca.sqlcode == DEADLOCK) goto retry_tran;

```

```

rc = sqlca.sqlcode;
if (acid->logging) {
    fprintf(out,"acidT **ERROR** sqlcode = %d\n",sqlca.sqlcode);
} else {
    fprintf(stderr,"acidT **ERROR** sqlcode = %d\n",sqlca.sqlcode);
} /* endif */
sqlerror("acidT: Close O_CURSOR", &sqlca);
goto Terror;
}

if (acid->logging) {
    gettimeofday(&tv, &tz);
    time(&timeT);
    fprintf(out,"acidT tag: %d, immediately before ROLLBACK: (%us
%06uu) %s",
        mypid, tv.tv_sec, tv.tv_usec, ctime(&timeT));
}
EXEC SQL rollback work;
if (sqlca.sqlcode != 0) {
    if (sqlca.sqlcode == DEADLOCK) goto retry_tran;
    rc = sqlca.sqlcode;
    if (acid->logging) {
        fprintf(out,"acidT **ERROR** sqlcode = %d\n",sqlca.sqlcode);
    } else {
        fprintf(stderr,"acidT **ERROR** sqlcode = %d\n",sqlca.sqlcode);
    } /* endif */
    sqlerror("acidT: ROLLBACK", &sqlca);
    goto Terror;
}
if (acid->logging) {
    gettimeofday(&tv, &tz);
    time(&timeT);
    fprintf(out,"acidT tag: %d, after ROLLBACK: (%us %06uu) %s",
        mypid, tv.tv_sec, tv.tv_usec, ctime(&timeT));
}
break;
}

acid->l_partkey = l_partkey;
acid->l_suppkey = l_suppkey;
acid->l_quantity = l_quantity;
acid->l_tax = l_tax;
acid->l_discount = l_discount;
acid->l_extendedprice = l_extendedprice;
acid->o_totalprice = o_totalprice;

rc = 0;
goto Texit;

Terror:
EXEC SQL CLOSE L_CURSOR;
if (sqlca.sqlcode != 0) sqlerror("acidT: Terror close L_CURSOR
failed", &sqlca);
EXEC SQL CLOSE O_CURSOR;
if (sqlca.sqlcode != 0) sqlerror("acidT: Terror close O_CURSOR
failed", &sqlca);
EXEC SQL rollback work;
if (sqlca.sqlcode != 0) sqlerror("acidT: ROLLBACK FAILED", &sqlca);

Texit:
if (acid->logging) {
    fprintf(out,"\n----- END of acidT tag: %d ----- \n\n",mypid);
    fflush(out);fclose(out);
}
return(rc);
}

/*-----*/
/* updateQ */
/*-----*/

```

```

int updateQ (struct update_struct *us)
{
    FILE *out;
    time_t timeT;
    struct timeval tv;
    struct timezone tz;
    int qnum;
    int rc = 0;
    int i;
    int secs2sleep;
    char buff[256];
    struct acidtype {int logging;} a, *acid;

EXEC SQL BEGIN DECLARE SECTION;
double acctbal;
double discount;
double price;
sqlint32 availqty;
sqlint32 size;
EXEC SQL END DECLARE SECTION;

qnum = us->qnum;

acid = &a;
acid->logging= 1;

sprintf(buff, "%s%cupdate.out",getenv("TPCD_TMP_DIR"),del());
out=fopen(buff,"a");

gettimeofday(&tv, &tz);
time(&timeT);
fprintf(out,"\n----- START of update ----- \n\n");
fprintf(out, "update query number: %d, begin transaction time: (%us
%06uu) %s",
    qnum, tv.tv_sec, tv.tv_usec, ctime(&timeT));

sqlca.sqlcode = 0;
discount = 0.25;
price = 5000.50;
acctbal = 1000.00;
availqty = 10;
size = 5;

for (i=1; i <= 2; i++) {
    gettimeofday(&tv, &tz);
    time(&timeT);
    fprintf(out,"update query number: %d, pass %d, immediately before
UPDATE: (%us %06uu) %s",
        qnum, i, tv.tv_sec, tv.tv_usec, ctime(&timeT));

    switch (qnum)
    {
    case 1:
    {
EXEC SQL

UPDATE TPCD.LINEITEM set L_DISCOUNT = L_DISCOUNT
+ :discount
WHERE L_ORDERKEY IN (326,512,928,995);
if (sqlca.sqlcode != 0) {
    rc = sqlca.sqlcode;
    if (acid->logging)
    {
        fprintf(out,"update query number: %d, pass %d, **ERROR**
sqlcode = %d\n",
            qnum, i, sqlca.sqlcode);
    }
    }
    else
    {

```



```

        fprintf(stderr,"update query number: %d, pass %d,
**ERROR** sqlcode = %d\n",
        qnum, i, sqlca.sqlcode);
    }
    sqlerror("update query number 1", &sqlca);
    goto Uerror;
}
discount = discount * (-1);
secs2sleep = 300;
break;
}
case 2:
{
EXEC SQL
UPDATE TPCD.SUPPLIER set S_ACCTBAL = S_ACCTBAL +
:acctbal
WHERE S_NAME in
('Supplier#000000647','Supplier#000000070','Supplier#000000802');
if (sqlca.sqlcode != 0) {
rc = sqlca.sqlcode;
if (acid->logging)
{
fprintf(out,"update query number: %d, pass %d, **ERROR**
sqlcode = %d\n",
sqlcode = %d\n",
qnum, i, sqlca.sqlcode);
}
else
{
fprintf(stderr,"update query number: %d, pass %d,
**ERROR** sqlcode = %d\n",
qnum, i, sqlca.sqlcode);
}
sqlerror("update query number 2", &sqlca);
goto Uerror;
}
acctbal = acctbal * (-1);
secs2sleep = 90;
break;
}
case 3:
{
EXEC SQL
UPDATE TPCD.LINEITEM set L_DISCOUNT = L_DISCOUNT
+ :discount
WHERE L_ORDERKEY IN (260930, 402497, 457859, 509889,
58117,
538311, 588421, 416167, 97830, 90276);
if (sqlca.sqlcode != 0) {
rc = sqlca.sqlcode;
if (acid->logging)
{
fprintf(out,"update query number: %d, pass %d, **ERROR**
sqlcode = %d\n",
sqlcode = %d\n",
qnum, i, sqlca.sqlcode);
}
else
{
fprintf(stderr,"update query number: %d, pass %d,
**ERROR** sqlcode = %d\n",
qnum, i, sqlca.sqlcode);
}
sqlerror("update query number 3", &sqlca);
goto Uerror;
}
discount = discount * (-1);
secs2sleep = 300;
break;
}
case 4:
{

```

```

if (i == 1) {
EXEC SQL
UPDATE TPCD.ORDERS set O_ORDERDATE =
O_ORDERDATE - 6 MONTHS
WHERE O_ORDERKEY = 67461;
/* WHERE O_ORDERKEY IN
(22400,28515,34338,46596,67461,92644,98307);*/
} else {
EXEC SQL
UPDATE TPCD.ORDERS set O_ORDERDATE =
O_ORDERDATE + 6 MONTHS
WHERE O_ORDERKEY = 67461;
}
if (sqlca.sqlcode != 0) {
rc = sqlca.sqlcode;
if (acid->logging)
{
fprintf(out,"update query number: %d, pass %d, **ERROR**
sqlcode = %d\n",
qnum, i, sqlca.sqlcode);
}
else
{
fprintf(stderr,"update query number: %d, pass %d,
**ERROR** sqlcode = %d\n",
qnum, i, sqlca.sqlcode);
}
sqlerror("update query number 4", &sqlca);
goto Uerror;
}
secs2sleep = 300;
break;
}
case 5:
{
EXEC SQL
UPDATE TPCD.LINEITEM set L_DISCOUNT = L_DISCOUNT
+ :discount
WHERE L_ORDERKEY IN
(70976,566279,152897,84226,232483);
if (sqlca.sqlcode != 0) {
rc = sqlca.sqlcode;
if (acid->logging)
{
fprintf(out,"update query number: %d, pass %d, **ERROR**
sqlcode = %d\n",
sqlcode = %d\n",
qnum, i, sqlca.sqlcode);
}
else
{
fprintf(stderr,"update query number: %d, pass %d,
**ERROR** sqlcode = %d\n",
qnum, i, sqlca.sqlcode);
}
sqlerror("update query number 5", &sqlca);
goto Uerror;
}
discount = discount * (-1);
secs2sleep = 300;
break;
}
case 6:
{
EXEC SQL
UPDATE TPCD.LINEITEM set L_DISCOUNT = L_DISCOUNT
+ :discount
WHERE L_ORDERKEY in
(33,131,161,195,229,230,231,323,353,356);
if (sqlca.sqlcode != 0) {
rc = sqlca.sqlcode;

```

```

        if (acid->logging)
        {
            fprintf(out,"update query number: %d, pass %d, **ERROR**
sqlcode = %d\n",
                qnum, i, sqlca.sqlcode);
        }
        else
        {
            fprintf(stderr,"update query number: %d, pass %d,
**ERROR** sqlcode = %d\n",
                qnum, i, sqlca.sqlcode);
        }
        sqlerror("update query number 6", &sqlca);
        goto Uerror;
    }
    discount = discount * (-1);
    secs2sleep = 300;
    break;
}
case 7:
{
    EXEC SQL
    UPDATE TPCD.LINEITEM set L_DISCOUNT = L_DISCOUNT
+ :discount
    WHERE L_ORDERKEY IN
(562917,410659,16550,398401,157634,429920,45411);
    if (sqlca.sqlcode != 0) {
        rc = sqlca.sqlcode;
        if (acid->logging)
        {
            fprintf(out,"update query number: %d, pass %d, **ERROR**
sqlcode = %d\n",
                qnum, i, sqlca.sqlcode);
        }
        else
        {
            fprintf(stderr,"update query number: %d, pass %d,
**ERROR** sqlcode = %d\n",
                qnum, i, sqlca.sqlcode);
        }
        sqlerror("update query number 7", &sqlca);
        goto Uerror;
    }
    discount = discount * (-1);
    secs2sleep = 300;
    break;
}
case 8:
{
    EXEC SQL
    UPDATE TPCD.LINEITEM set L_DISCOUNT = L_DISCOUNT
+ :discount
    WHERE L_ORDERKEY IN
(129569,343591,270242,254983,98500,28963);
    if (sqlca.sqlcode != 0) {
        rc = sqlca.sqlcode;
        if (acid->logging)
        {
            fprintf(out,"update query number: %d, pass %d, **ERROR**
sqlcode = %d\n",
                qnum, i, sqlca.sqlcode);
        }
        else
        {
            fprintf(stderr,"update query number: %d, pass %d,
**ERROR** sqlcode = %d\n",
                qnum, i, sqlca.sqlcode);
        }
    }
    sqlerror("update query number 8", &sqlca);
}

```

```

        goto Uerror;
    }
    discount = discount * (-1);
    secs2sleep = 300;
    break;
}
case 9:
{
    EXEC SQL
    UPDATE TPCD.LINEITEM set L_DISCOUNT = L_DISCOUNT
+ :discount
    WHERE L_ORDERKEY IN
(113509,232997,246691,379233,448162,32134);
    if (sqlca.sqlcode != 0) {
        rc = sqlca.sqlcode;
        if (acid->logging)
        {
            fprintf(out,"update query number: %d, pass %d, **ERROR**
sqlcode = %d\n",
                qnum, i, sqlca.sqlcode);
        }
        else
        {
            fprintf(stderr,"update query number: %d, pass %d,
**ERROR** sqlcode = %d\n",
                qnum, i, sqlca.sqlcode);
        }
        sqlerror("update query number 9", &sqlca);
        goto Uerror;
    }
    discount = discount * (-1);
    secs2sleep = 300;
    break;
}
case 10:
{
    EXEC SQL
    UPDATE TPCD.LINEITEM set L_DISCOUNT = L_DISCOUNT
+ :discount
    WHERE L_ORDERKEY IN
(516487,245411,265799,253025,6914,562020);
    if (sqlca.sqlcode != 0) {
        rc = sqlca.sqlcode;
        if (acid->logging)
        {
            fprintf(out,"update query number: %d, pass %d, **ERROR**
sqlcode = %d\n",
                qnum, i, sqlca.sqlcode);
        }
        else
        {
            fprintf(stderr,"update query number: %d, pass %d,
**ERROR** sqlcode = %d\n",
                qnum, i, sqlca.sqlcode);
        }
        sqlerror("update query number 10", &sqlca);
        goto Uerror;
    }
    discount = discount * (-1);
    secs2sleep = 300;
    break;
}
case 11:
{
    EXEC SQL
    UPDATE TPCD.PARTSUPP set PS_AVAILQTY =
PS_AVAILQTY + :availqty
    WHERE PS_PARTKEY IN
(12098,5134,13334,17052,3452,12552,1084,5797);
}

```

```

if (sqlca.sqlcode != 0) {
    rc = sqlca.sqlcode;
    if (acid->logging)
    {
        fprintf(out,"update query number: %d, pass %d, **ERROR**
sqlcode = %d\n",
            qnum, i, sqlca.sqlcode);
    }
    else
    {
        fprintf(stderr,"update query number: %d, pass %d,
**ERROR** sqlcode = %d\n",
            qnum, i, sqlca.sqlcode);
    }
    sqlerror("update query number 11", &sqlca);
    goto Uerror;
}
availqty = availqty * (-1);
secs2sleep = 180;
break;
}
case 12:
{
    if ( i == 1 ) {
        EXEC SQL
            UPDATE TPCD.LINEITEM set L_RECEIPTDATE =
L_RECEIPTDATE - 3 YEARS
            WHERE L_ORDERKEY IN
(33,70,195,355,677,837,960,962,1028);
    } else {
        EXEC SQL
            UPDATE TPCD.LINEITEM set L_RECEIPTDATE =
L_RECEIPTDATE + 3 YEARS
            WHERE L_ORDERKEY IN
(33,70,195,355,677,837,960,962,1028);
    }
    if (sqlca.sqlcode != 0) {
        rc = sqlca.sqlcode;
        if (acid->logging)
        {
            fprintf(out,"update query number: %d, pass %d, **ERROR**
sqlcode = %d\n",
                qnum, i, sqlca.sqlcode);
        }
        else
        {
            fprintf(stderr,"update query number: %d, pass %d,
**ERROR** sqlcode = %d\n",
                qnum, i, sqlca.sqlcode);
        }
        sqlerror("update query number 12", &sqlca);
        goto Uerror;
    }
    secs2sleep = 300;
    break;
}
case 13:
{
    EXEC SQL
        UPDATE TPCD.LINEITEM set L_DISCOUNT = L_DISCOUNT
+ :discount
        WHERE L_ORDERKEY IN
(263,9476,32355,34854,53445,56901);
    if (sqlca.sqlcode != 0) {
        rc = sqlca.sqlcode;
        if (acid->logging)
        {
            fprintf(out,"update query number: %d, pass %d, **ERROR**
sqlcode = %d\n",

```

```

            qnum, i, sqlca.sqlcode);
        }
        else
        {
            fprintf(stderr,"update query number: %d, pass %d,
**ERROR** sqlcode = %d\n",
                qnum, i, sqlca.sqlcode);
        }
        sqlerror("update query number 13", &sqlca);
        goto Uerror;
    }
    discount = discount * (-1);
    secs2sleep = 90;
    break;
}
case 14:
{
    EXEC SQL
        UPDATE TPCD.LINEITEM set L_DISCOUNT = L_DISCOUNT
+ :discount
        WHERE L_ORDERKEY IN (32,225,326,448,449,483,512);
    if (sqlca.sqlcode != 0) {
        rc = sqlca.sqlcode;
        if (acid->logging)
        {
            fprintf(out,"update query number: %d, pass %d, **ERROR**
sqlcode = %d\n",
                qnum, i, sqlca.sqlcode);
        }
        else
        {
            fprintf(stderr,"update query number: %d, pass %d,
**ERROR** sqlcode = %d\n",
                qnum, i, sqlca.sqlcode);
        }
        sqlerror("update query number 14", &sqlca);
        goto Uerror;
    }
    discount = discount * (-1);
    secs2sleep = 180;
    break;
}
case 15:
{
    EXEC SQL
        UPDATE TPCD.LINEITEM set L_DISCOUNT = L_DISCOUNT
+ :discount
        WHERE L_ORDERKEY IN (1,4,7,35,135,131300);
    if (sqlca.sqlcode != 0) {
        rc = sqlca.sqlcode;
        if (acid->logging)
        {
            fprintf(out,"update query number: %d, pass %d, **ERROR**
sqlcode = %d\n",
                qnum, i, sqlca.sqlcode);
        }
        else
        {
            fprintf(stderr,"update query number: %d, pass %d,
**ERROR** sqlcode = %d\n",
                qnum, i, sqlca.sqlcode);
        }
        sqlerror("update query number 15", &sqlca);
        goto Uerror;
    }
    discount = discount * (-1);
    secs2sleep = 180;
    break;
}

```

```

}
case 16:
{
EXEC SQL
UPDATE TPCD.PART set P_SIZE = P_SIZE + :size
WHERE P_PARTKEY IN (4,7,15,1313);
if (sqlca.sqlcode != 0) {
rc = sqlca.sqlcode;
if (acid->logging)
{
fprintf(out,"update query number: %d, pass %d, **ERROR**
sqlcode = %d\n",
qnum, i, sqlca.sqlcode);
}
else
{
fprintf(stderr,"update query number: %d, pass %d,
**ERROR** sqlcode = %d\n",
qnum, i, sqlca.sqlcode);
}
sqlerror("update query number 16", &sqlca);
goto Uerror;
}
size = size * (-1);
secs2sleep = 180;
break;
}
case 17:
{
EXEC SQL
UPDATE TPCD.LINEITEM set L_EXTENDEDPRI =
L_EXTENDEDPRI + :price
WHERE L_ORDERKEY IN
(4065,110372,165061,265702,87138);
if (sqlca.sqlcode != 0) {
rc = sqlca.sqlcode;
if (acid->logging)
{
fprintf(out,"update query number: %d, pass %d, **ERROR**
sqlcode = %d\n",
qnum, i, sqlca.sqlcode);
}
else
{
fprintf(stderr,"update query number: %d, pass %d,
**ERROR** sqlcode = %d\n",
qnum, i, sqlca.sqlcode);
}
sqlerror("update query number 17", &sqlca);
goto Uerror;
}
price = price * (-1);
secs2sleep = 90;
break;
}
default:
{
fprintf(out,"ERROR: Invalid query number specified %d\n",
qnum);
rc = 1;
goto Uexit;
}
}

gettimeofday(&tv, &tz);
time(&timeT);

if (acid->logging)
fprintf(out,"update query number: %d, pass %d, after UPDATE:
(%us %06uu) %s",

```

```

qnum, i, tv.tv_sec, tv.tv_usec, ctime(&timeT));
else
fprintf(stderr,"update query number: %d, pass %d, after
UPDATE: (%us %06uu) %s",
qnum, i, tv.tv_sec, tv.tv_usec, ctime(&timeT));

if ( i == 2 ) {
gettimeofday(&tv, &tz);
time(&timeT);
fprintf(out,"update query number: %d, pass %d, sleeping for %d
seconds: (%us %06uu) %s",
qnum, i, secs2sleep, tv.tv_sec, tv.tv_usec, ctime(&timeT));
fflush(out);
system("touch /tmp/tpcd/update.sync.sleep");

sleep(secs2sleep);
}

gettimeofday(&tv, &tz);
time(&timeT);
fprintf(out,"update query number: %d, pass %d, immediately before
COMMIT: (%us %06uu) %s",
qnum, i, tv.tv_sec, tv.tv_usec, ctime(&timeT));

EXEC SQL COMMIT;
if (sqlca.sqlcode != 0) {
rc = sqlca.sqlcode;
fprintf(out,"update pass %d, **ERROR** sqlcode = %d\n", i,
sqlca.sqlcode);
sqlerror("update: COMMIT", &sqlca);
goto Uerror;
}
gettimeofday(&tv, &tz);
time(&timeT);
if (acid->logging)
fprintf(out,"update query number: %d, pass %d, after COMMIT:
(%us %06uu) %s",
qnum, i, tv.tv_sec, tv.tv_usec, ctime(&timeT));
else
fprintf(stderr,"update query number: %d, pass %d, after
COMMIT: (%us %06uu) %s",
qnum, i, tv.tv_sec, tv.tv_usec, ctime(&timeT));
}

rc = 0;
goto Uexit;

Uerror:
EXEC SQL rollback work;
if (sqlca.sqlcode != 0) sqlerror("update: ROLLBACK FAILED",
&sqlca);
system("touch /tmp/tpcd/update.sync.sleep");

Uexit:
fprintf(out,"\n----- END of update ----- \n\n");
fflush(out);fclose(out);
return(rc);
}

/*-----*/
/* connect_to_TM */
/*-----*/
void connect_to_TM( void )
{
char *dbname_ptr;
if ((dbname_ptr = getenv("TPCD_QUAL_DBNAME")) != NULL) {
fprintf(stderr,"***** %s *****\n",dbname_ptr);
strcpy (dbname, dbname_ptr);
}
}

```

```

EXEC SQL CONNECT TO :dbname IN SHARE MODE;
if (sqlca.sqlcode < 0) {
    fprintf(stderr, "CONNECT TO %s failed SQLCODE = %d\n",
dbname, sqlca.sqlcode);
    exit(-1);
}
return;
}

/*-----*/
/*    disconnect_from_TM    */
/*-----*/
void disconnect_from_TM ( void )
{
    EXEC SQL CONNECT RESET;
    if (sqlca.sqlcode < 0) {
        fprintf(stderr, "DISCONNECT failed SQLCODE = %d\n",
sqlca.sqlcode);
        exit(-1);
    }
    return;
}

/*-----*/
/*    sqlerror    */
/*-----*/
void sqlerror(char *msg, struct sqlca *psqlca)
{
    FILE *err_fp;

    char err_fn[256];

    int j,k;

    sprintf(err_fn,
"%s%cacid.sqlerrors",getenv("TPCD_TMP_DIR"),del());
    err_fp=fopen(err_fn,"a");
    fprintf(err_fp,"acid: sqlcode: %4d %s\n", psqlca->sqlcode, msg);
    fprintf(stderr,"acid: sqlcode: %4d %s\n", psqlca->sqlcode, msg);
    fflush(stderr);
    if (psqlca->sqlerrmc[0] != ' ' || psqlca->sqlerrmc[1] != ' ') {
        fprintf(err_fp,"acid: slerrmc: ");
        for(j = 0; j < 5; j++)
        {
            for(k = 0; k < 14; k++) fprintf(err_fp,"%x ", psqlca-
>sqlerrmc[j]*10+k);
            fprintf(err_fp," ");
            for(k = 0; k < 14; k++) fprintf(err_fp,"%c", psqlca-
>sqlerrmc[j]*10+k);
            fprintf(err_fp,"\n");
            if (j < 4) fprintf(err_fp," ");
        }
    }

    fprintf(err_fp,"acid: sqlerrp: ");
    for(j = 0; j < 8; j++) fprintf(err_fp,"%c", psqlca->sqlerrp[j]);
    fprintf(err_fp,"\n");

    fprintf(err_fp,"acid: sqlerrd: ");
    for(j = 0; j < 6; j++) fprintf(err_fp," %d", psqlca->sqlerrd[j]);
    fprintf(err_fp,"\n");

    if (psqlca->sqlwarn[0] != ' ') {
        fprintf(err_fp,"acid: sqlwarn: ");
        for(j = 0; j < 8; j++) fprintf(err_fp,"%c ", psqlca->sqlwarn[j]);
        fprintf(err_fp,"\n");
    }
}

```

```

fprintf(err_fp,"\n");
fflush(err_fp);fclose(err_fp);
}

#ifdef SQLWINT
void sleep(int sec)
{
    Sleep(sec * 1000);
}
#endif

char del(void)
{
#ifdef SQLWINT
    return '\\';
#else
    return '/';
#endif
}

#if defined(SQLPTX) || defined(SQLWINT) || defined(SQLSUN) ||
defined(Linux)
/* added for PTX as this one is not there in libm */
double nearest(double x)
{
    double y, z;

    y = x;
    if (x < 0)
        y = -x;
    z = y - (int)y;
    if (z == 0.5) {
        if ((int)floor(y) % 2) {
            return((x < 0) ? -ceil(y) : ceil(y));
        } else {
            return((x < 0) ? -floor(y) : floor(y));
        }
    } else if (z < 0.5)
        return((x < 0) ? -floor(y) : floor(y));

    else
        return((x < 0) ? -ceil(y) : ceil(y));
}
#endif /* SQLPTX */

```

E.2 acid.h

```

/*****
/* File: acid.h */
*****/

#include <stdio.h>
#include <stdlib.h>
#include <time.h>

#ifdef SQLWINT
#include <windows.h>
#include <sys/timeb.h>
#include <sys/stat.h>
#include <stdlib.h>
#include <io.h>
#else
#include <unistd.h>
#include <sys/time.h>
#include <sys/timeb.h>
#endif

```

```

#include <string.h>
#include <math.h>

#define acidtime(tvsec,tvusec) tvsec*1000+tvusec/1000
#define TSLEN 20

#if 0 /* needed on NT, not on AIX */
typedef struct timeval {
    long   tv_sec;    /* seconds */
    long   tv_usec;  /* and microseconds */
};
#endif

struct update_struct {
    int    qnum;
};

struct acidQ_struct {
    int    tag;
    long   o_key;
    double l_extendedprice;
};

struct acidT_struct {
    int    termination;
    int    tag;
    int    logging;
    long   o_key;
    long   l_key;
    long   delta;
    long   l_partkey;
    long   l_suppkey;
    double l_quantity;
    double l_tax;
    double l_discount;
    double l_extendedprice;
    double o_totalprice;
};

/*
** in acid.sqc
*/

int updateQ (struct update_struct *us);

char del(void);

#ifdef SQLWINT
void sleep (int sec);
#endif

```

```

LFLAGS =      -lm -lbsd -q64
# sun .... LFLAGS =      -lm

LIB      =      -L$(HOME)/sqllib/lib -ldb2

CC      =      cc

HDR      =      acid.h
C      =      mainacid.c
SQC      =      acid.sqc
SRC      =      $(HDR)          $(C)          $(SQC)
OBJ      =      acid.o
EXEC     =      mainacid

TARGET  =      $(EXEC) tsec

.SUFFIXES: .o .c .sqc .bnd

.c.o:
    $(CC) -c $(CFLAGS)

all:     $(TARGET)

mainacid: $(SRC) $(OBJ) mainacid.o
    $(CC) -o $$@ $(CFLAGS) $(OBJ) mainacid.o $(LIB)
    $(LFLAGS)

acid.c: acid.sqc $(HDR)
    - db2 connect to $(DBNAME); \
    db2 prep acid.sqc BINDFILE ISOLATION RR
NOLINEMACRO PACKAGE; \
    db2 bind acid.bnd GRANT PUBLIC; \
    db2 connect reset; \
    db2 terminate

acid.o: acid.c
    $(CC) $(CFLAGS) -c acid.c -o acid.o

tsec: tsec.c
    $(CC) $(CFLAGS) $(LFLAGS) -o tsec tsec.c

clean:
    rm -f *.o *.bnd $(EXEC) tsec
    rm -f acid.c

```

E.3 Makefile

```

DBNAME =      $(TPCD_QUAL_DBNAME)

INCLUDE =     $(HOME)/sqllib/include

#CFLAGS      =      -I$(INCLUDE) -g -Dpascal= -
DLINT_ARGS \
#           -Dfar= -D_loadds= -DSQLA_NOLINES -qflag=i:i -
qlanglvl=ansi

#LFLAGS      =      -lm -lcurses -ls -ll -ly -liconv -lbsd
CFLAGS      =      -I$(INCLUDE) -g -Dpascal= -DLINT_ARGS \
                -DSQLA_NOLINES -qflag=i:i -qlanglvl=ansi -q64
# .. sun     -DSQLA_NOLINES

```

Appendix - F Third Party Pricing

F.1 CDW Pricing



800.750.4239

SHOPPING CART

[▶ Your Saved Carts](#) [▶ Save This Cart](#) [▶ Edit Saved Carts](#) [▶ Send To An Associate](#)

[Continue to Checkout](#)

Quantity	Product	CDW	Usually Ships	Price	Ext. Price
<input type="text" value="1"/>	Cisco Catalyst WS-C3750G-24TS-S 10/100/1000 switch	496453	Same Day	\$5,129.20	\$5,129.20
<input type="text" value="3"/>	Cisco SMARTnet Onsite 1 Year 24x7 4 Hour	137978	1-2 Weeks	\$1,297.99	\$3,893.97
Click to remove an item from your cart				Sub-Total	\$9,023.17

Update

Clear Cart

[Continue to Checkout](#)